

User Manual

NUX Drum System

DM-310H DIGITAL DRUM KIT

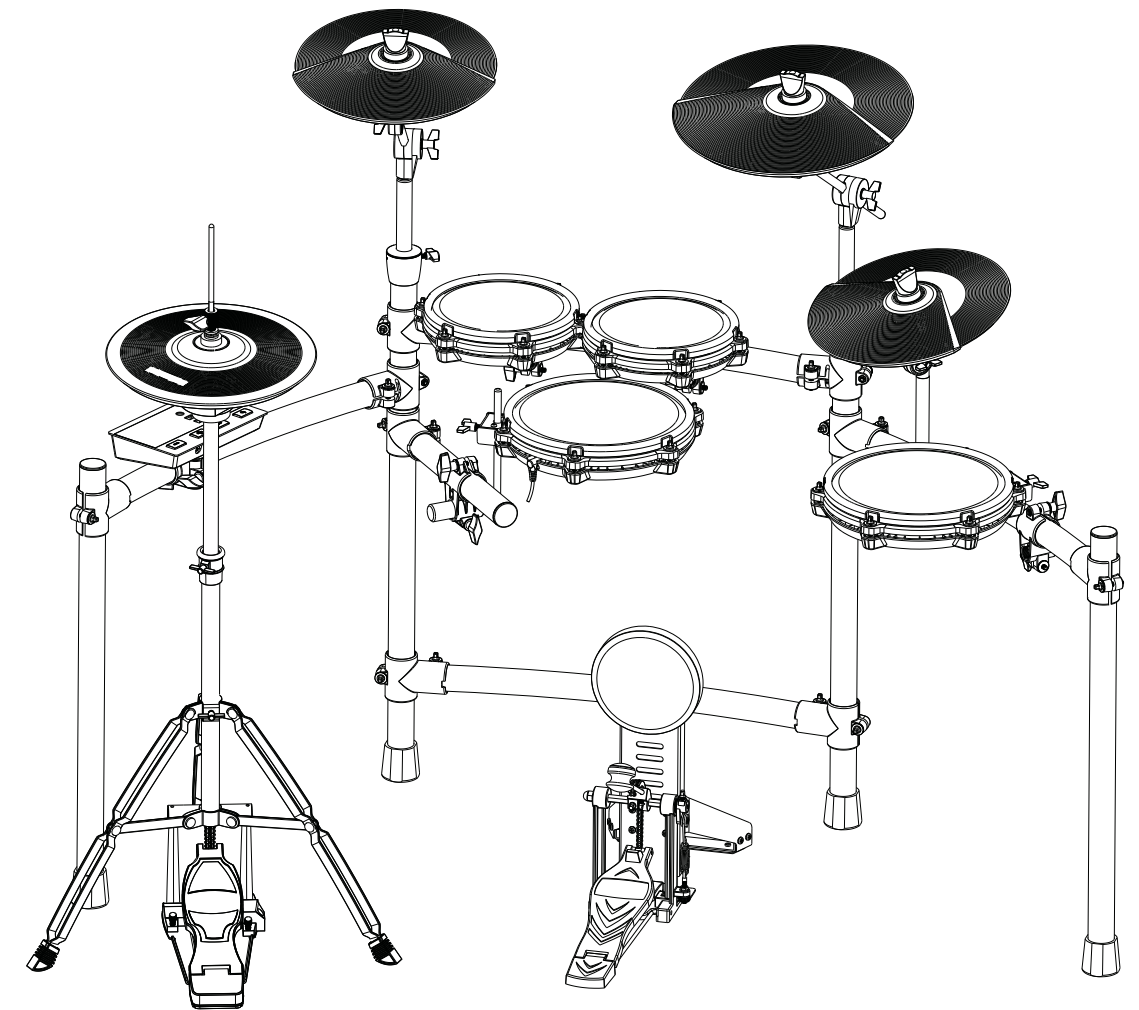

©Cherub Technology Co., Ltd.



All Rights Reserved. No part of this publication may be reproduced, stored in a retrieval system, or transmitted, in any form or by any means, electronic, mechanical, photocopying, recording, or otherwise, without the prior written permission of Cherub Technology Co., Ltd.



NUX
Cherub Technology Co., Ltd.
www.nuxaudio.com

USING THE UNIT SAFELY

INSTRUCTIONS FOR THE PREVENTION OF FIRE, ELECTRIC SHOCK, OR INJURY TO PERSONS

 WARNING	Used for instructions intended to alert the user to the risk of death or severe injury should the unit be used improperly.	 CAUTION	Used for instructions intended to alert the user to the risk of injury or material damage should the unit be used improperly. * Material damage refers to damage or other adverse effects caused with respect to the home and all its furnishings, as well to domestic animals or pets.
-----------------------------------------------------------------------------------------------------	----------------------------------------------------------------------------------------------------------------------------	-----------------------------------------------------------------------------------------------------	--------------------------------------------------------------------------------------------------------------------------------------------------------------------------------------------------------------------------------------------------------------------------------------------

ALWAYS OBSERVE THE FOLLOWING

WARNING

WARNING

- Before using this unit, make sure to read the instructions below and the Owner's Manual.
.....
- Do not open (or modify in any way) the unit or its AC adaptor.
.....
- Do not attempt to repair the unit, or replace parts within it (except when this manual provides specific instructions directing you to do so). Refer all servicing to your retailer, the nearest NUX Service Center.
.....
- Never use or store the unit in places that are:
 - Subject to temperature extremes (e.g., direct sunlight in an enclosed vehicle, near a heating duct, on top of heat-generating equipment).
 - Damp (e.g., baths, washrooms, on wet floors).
 - Humid.
 - Exposed to rain.
 - Dusty.
 - Subject to high levels of vibration.
.....
- This unit may be installed on stand using a Clamp.
.....
- When installing the unit on a stand with a clamp, the stand must not be placed in an unstable location or on an incline, but in a level and stable position. Even if a stand is not used, make sure that the unit is placed in a stable location.

- Be sure to use only the AC adaptor supplied with the unit. Also, make sure the line voltage at the installation matches the input voltage specified on the AC adaptor's body. Other AC adaptors may use a different polarity, or be designed for a different voltage, so their use could result in damage, malfunction, or electric shock.
.....
- Do not excessively twist or bend the power cord, nor place heavy objects on it. Doing so can damage the cord, producing severed elements and short circuits. Damaged cords are fire and shock Hazards!
.....
- This unit, either alone or in combination with an amplifier and headphones or speakers, may be capable of producing sound levels that could cause permanent hearing loss. Do not operate for a long period of time at a high volume level, or at a level that is uncomfortable. If you experience any hearing loss or ringing in the ears, you should immediately stop using the unit, and consult an Audiologist.
.....
- Do not allow any objects (e.g., flammable material, coins, pins); or liquids of any kind (water, soft drinks, etc.) to penetrate the unit.

WARNING

- Immediately turn the power off, remove the AC adaptor from the outlet, and request servicing by your retailer, the nearest NUX Service Center.
 - The AC adaptor or the power-supply cord has been damaged.
 - If smoke or an unusual odor occurs.
 - Objects have fallen into, or liquid has been spilled onto the unit.
 - The unit has been exposed to rain (or otherwise has become wet).
 - The unit does not appear to operate normally or exhibits a marked change in performance.
.....
- In households with small children, an adult should provide supervision until the child is capable of following all the rules essential for the safe operation of the unit.
.....
- Protect the unit from strong impact.
(Do not drop it!)
.....
- Do not force the unit's power-supply cord to share an outlet with an unreasonable number of other devices. Be especially careful when using extension cords-the total power used by all devices you have connected to the extension cord's outlet must never exceed the power rating (watts/amperes) for the extension cord. Excessive loads can cause the insulation on the cord to heat up and eventually melt through.
.....
- Before using the unit in a foreign country, consult with your retailer, the nearest NUX Service Center.

CAUTION

- The unit and the AC adaptor should be located so their location or position does not interfere with their proper ventilation.
.....
- Always grasp only the output plug or the body of the AC adaptor when plugging into, or unplugging from, this unit or an outlet.
.....
- Any accumulation of dust between the AC adaptor and the power outlet can result in poor insulation and lead to fire. Periodically wipe away such dust with a dry cloth. Also, disconnect the power plug from the power outlet whenever the unit is to remain unused for an extended period of time.
.....
- Try to prevent cords and cables from becoming entangled. Also, all cords and cables should be placed so they are out of the reach of children.
.....
- Never climb on top of, nor place heavy objects on the unit.
.....
- Never handle the AC adaptor body, or its output plugs, with wet hands when plugging into, or unplugging from, an outlet or this unit.
.....
- If you need to move the instrument, take note of the precautions listed below. Make sure to have a firm grip, to protect yourself from injury and the instrument from damage.
 - Check to make sure that the clamp that fixes the unit to the stand has not become loose. Fasten them again securely whenever you notice any loosening.
 - Disconnect the power cord.
 - Disconnect all cords coming from external devices.
.....
- Before cleaning the unit, turn off the power and unplug the AC adaptor from the outlet.
.....
- Whenever you suspect the possibility of lightning in your area, disconnect the AC adaptor from the outlet.
.....
- Should you remove security screws, make sure to put them in a safe place out of children's reach, so there is no chance of them being swallowed accidentally.

Quick installation guide

Unit

1



Left straight tube 680 x 1

2



Right straight tube 680 x 1

3



Left straight tube 800 x 1

4



Right straight tube 800 x 1

5



Left curve tube 610 x 1

6

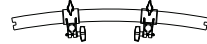

Right curve tube 610 x 1

7



Top curve tube 610 x 1

8



Bottom curve tube 610 x 1

9



Straight tube 320 x 1

10

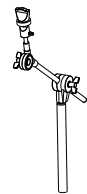

Cymbal boom arm x 2

11



Straight arm x 1

12



Hold x 4

Quick installation guide

13

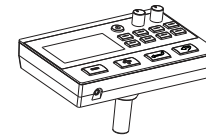

Module x 1

14

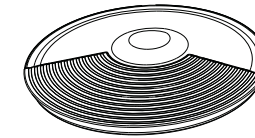

12" cymbal x 2

15

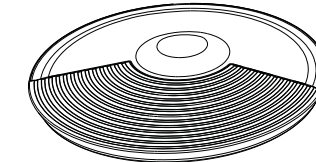

14" cymbal x 1

16

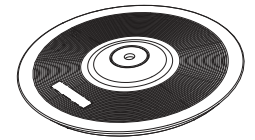

Hi-hat cymbal x 1

17

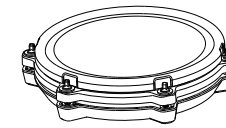

8" mesh drum pad x 2

18

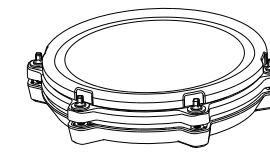

10" mesh drum pad x 2

19

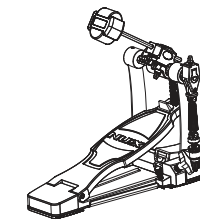

Kick pedal x 1

20

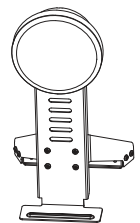

Kick drum x 1

21

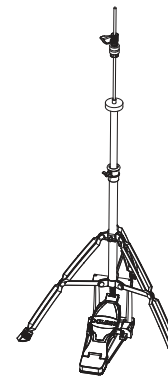

Snare stand x 1

22



Hi-hat control x 1

23

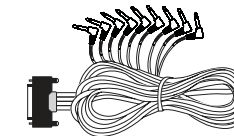

Cable x 1

24

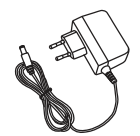

Power adapter x 1

Quick installation guide

Install

1. Install the drum rack

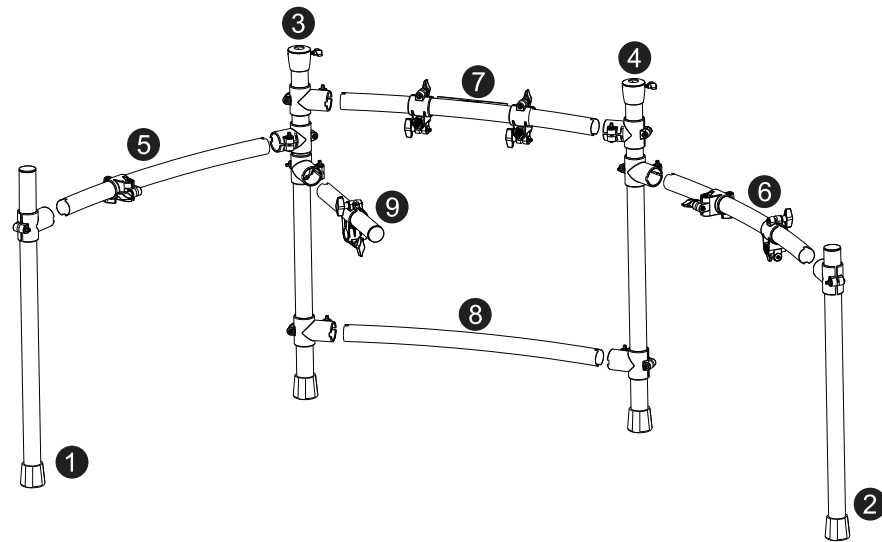

2. Install the cymbal arm and drum holder

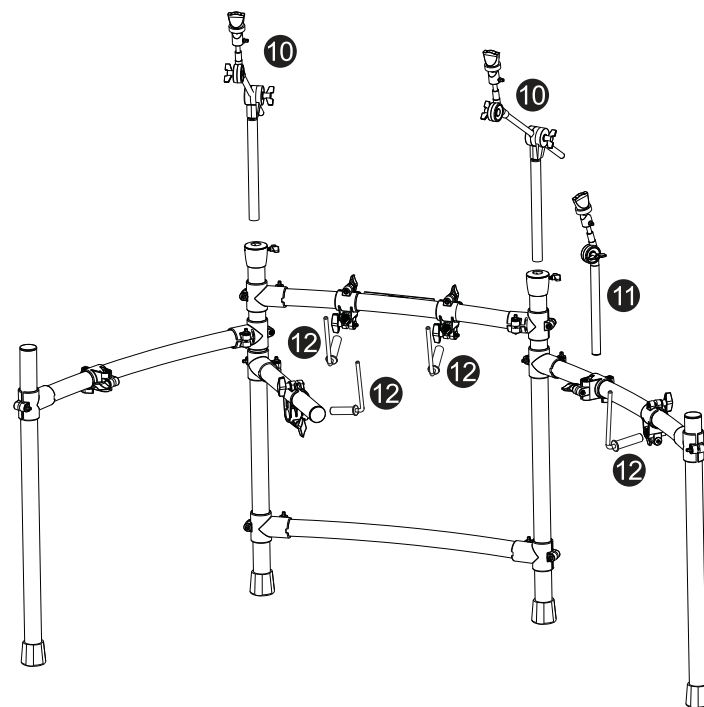

Quick installation guide

3. Install the drum pads, snare, cymbals

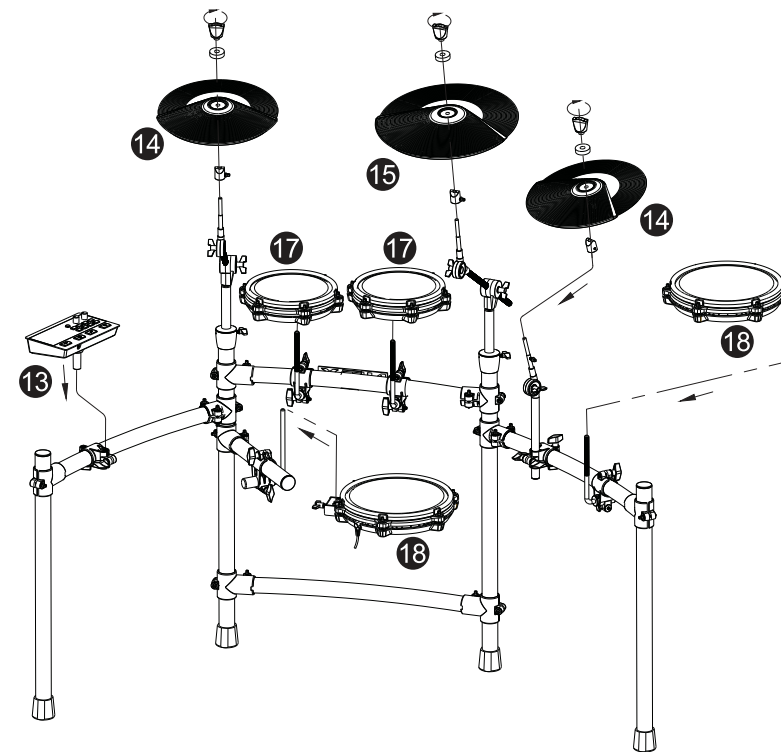

4. Install the hi-hat and kick

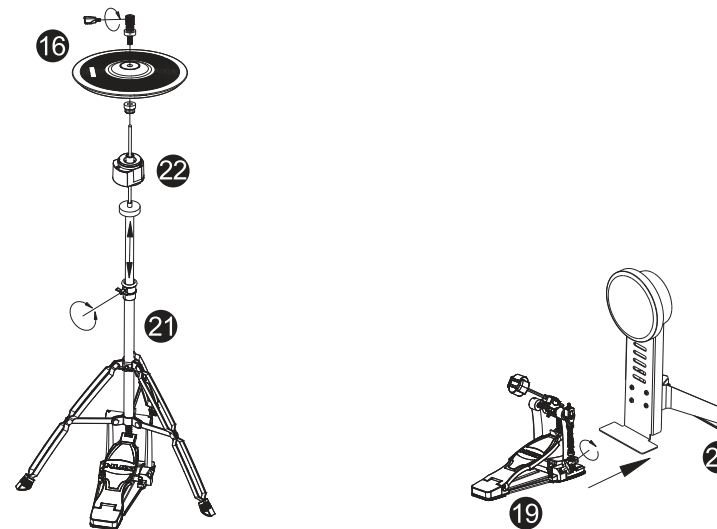

Install the hi-hat

Install the kick and kick pedal

Quick installation guide

5. Connect the cables

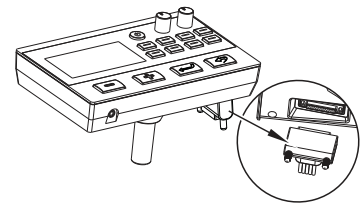

Module

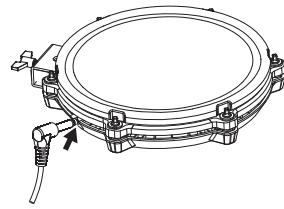

Tom

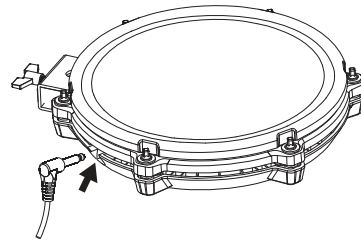

Snare

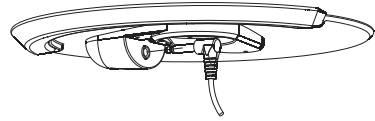

Cymbal

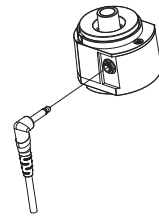

Hi-hat Control

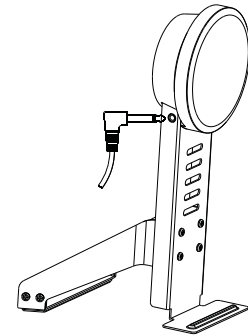

Kick

6. Ready to go!

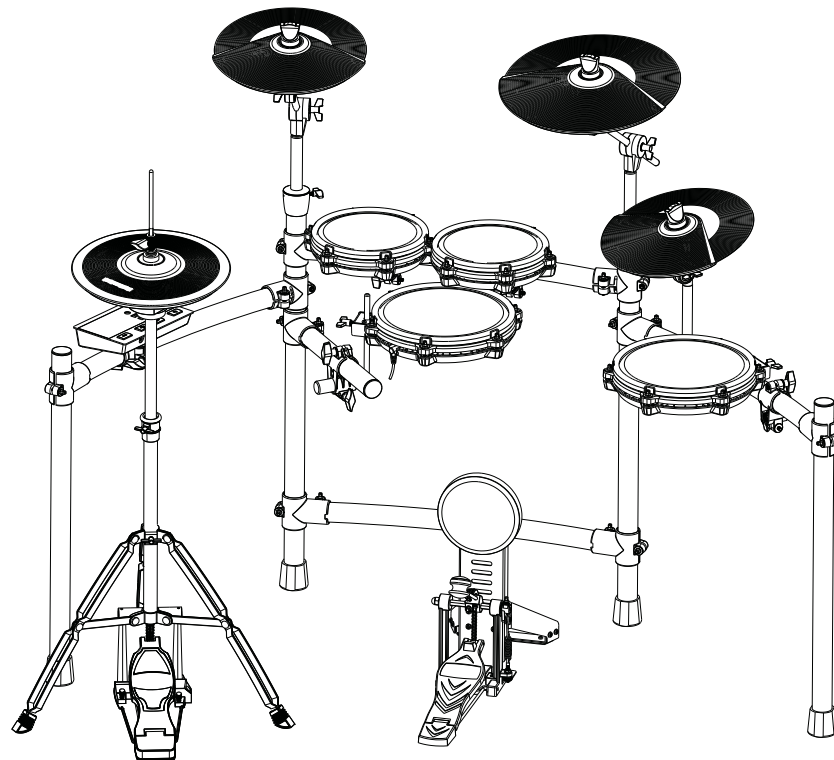

Quick installation guide

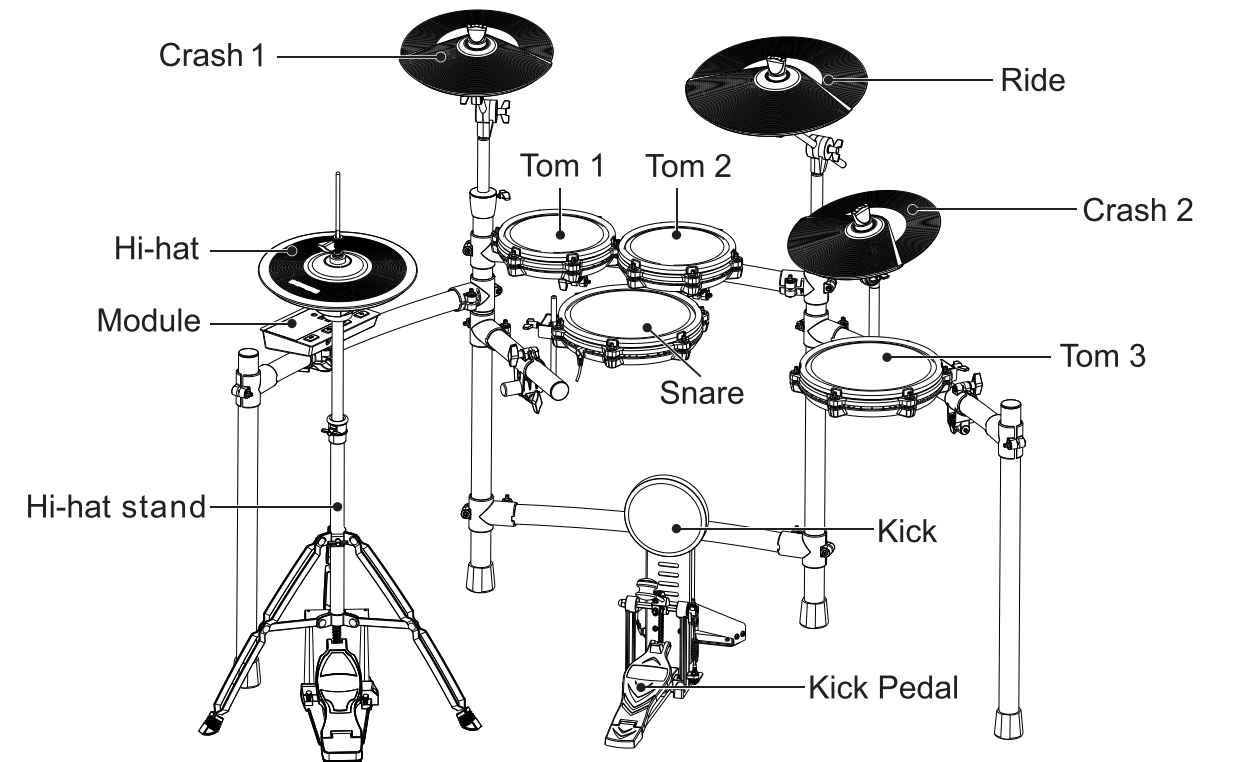

Module Control Panel.....	02
The front panel.....	02
Interface panel.....	02
Connect External Devices.....	03
About the Screen.....	04
Get ready to play.....	05
Power on/off.....	05
How to Play.....	05
Function Operation.....	07
TONE adjustment.....	07
COACH.....	07
Recording function.....	08
System Settings.....	09
HIHAT SET.....	09
CLICK.....	09
EFFECT.....	09
TRIGGER.....	10
PANNING.....	10
KIT NAME.....	10
OUTPUT.....	11
MIDI NOTE.....	11
RESET.....	11
OPTION.....	11
USB AUDIO/USB MIDI.....	11
BLUETOOTH.....	12
AUX IN.....	12
External trigger input.....	12
Specification.....	13

■ The front panel



Number	Name
①	POWER button
②	PHONES VOLUME knob
③	MASTER knob
④	TONE button
⑤	CLICK button
⑥	REVERB button
⑦	KIT button
⑧	MENU button

Number	Name
⑨	COACH button
⑩	REC button
⑪	PLAY/STOP button
⑫	- Parameter adjustment button
⑬	+ Parameter adjustment button
⑭	ENTER button
⑮	RETURN button
⑯	PHONES jack

■ Interface panel



Number	Name
⑰	USB Port
⑱	TRIGGER jack
⑲	BLUETOOTH MODULE NBT-1 jack
⑳	AUX IN

Number	Name
⑳	L/MONO OUTPUT
㉑	R OUTPUT
㉒	DC 9V jack

Connect External Devices

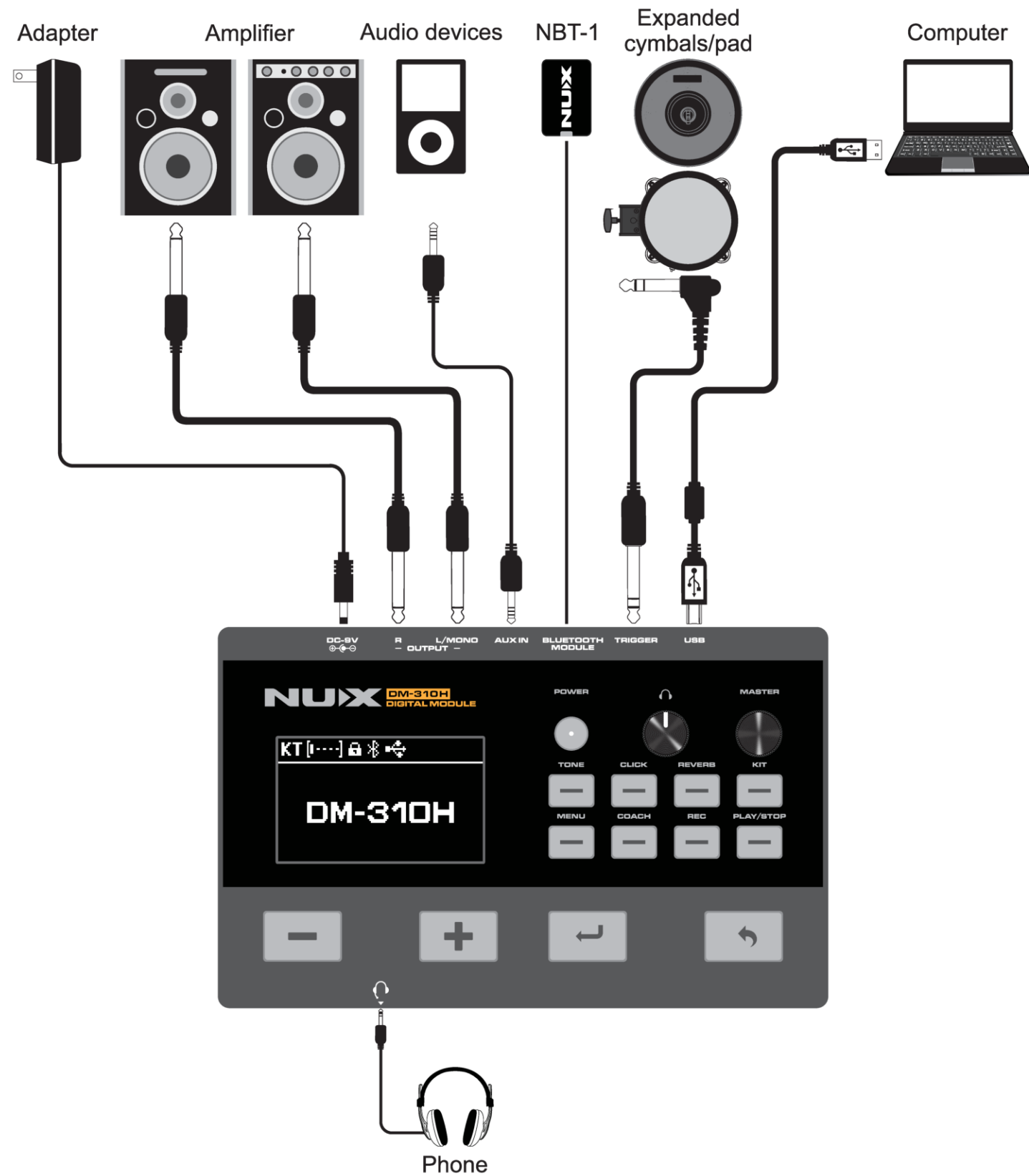

⚠ WARNING

In order to prevent equipment damage, please shut down during the connection process.

About the Screen



Number	Name
1	The pad being played now
2	Strength display
3	Memory lock icon

Number	Name
4	Bluetooth icon
5	USB icon

Get ready to play

Power on/off

* Turn on the power

1. Set the [MASTER] and [PHONES] knobs off to minimum levels.
2. Turn down the volume of the external amplifier.
3. Press [POWER] knobs to turn the DM-310H on.



**When you turn on the power supply, you may hear a slight, electric current, which is normal. Turn off the power.*

4. Hit the pad and adjust the volume as you need.

How to Play

* Tom

Head shot
Hit the head.

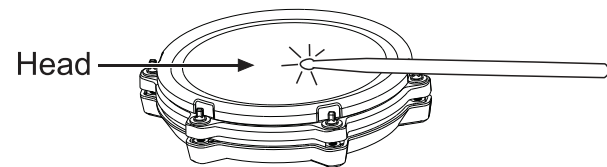

Rim click
Hit the rim.

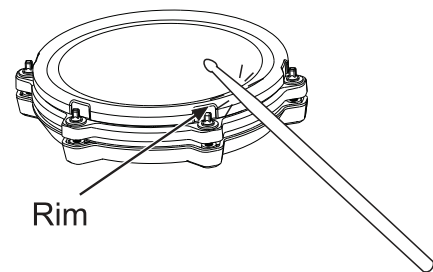

* Turn off the power

1. Turn down the volume of the amplifier or turn off the amplifier first.
2. Turn off the power of DM-310H.

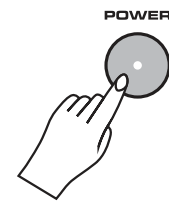

* Snare

Head shot
Hit the head.

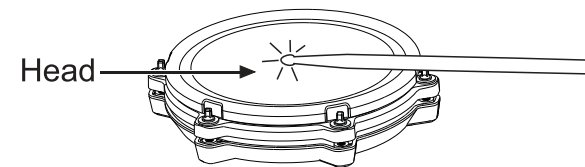

Cross stick
Hit the rim.

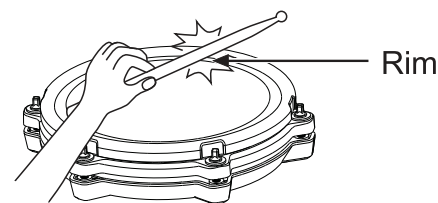

* Kick

Strike down the kick pedal.

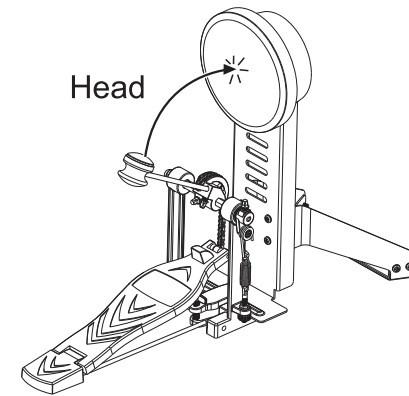

* Crash ride

Bow shot
Hit the bow.

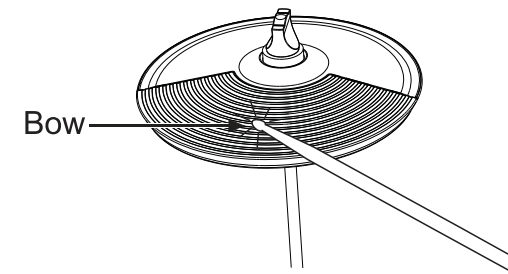

Edge shot
Hit the edge.

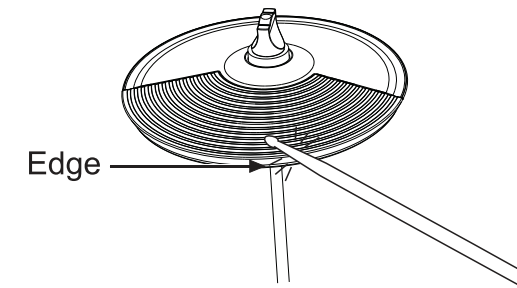

Choke

Choke the cymbal's edge with the hand immediately after hitting the cymbal will mute the sound. The choke function only works when you grasp in the area.

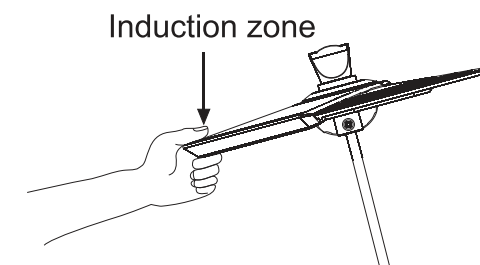

* Hi-hat

The hi-hat sound will change smoothly between open, half-open and closed depending on pressure applied to the hi-hat control pedal.

Bow shot
Hit the bow.

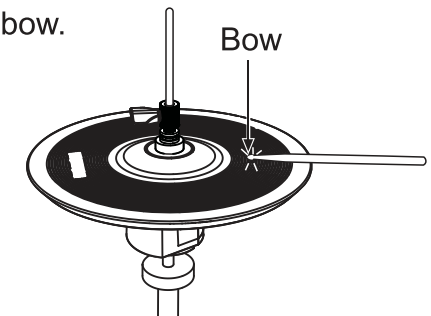

Edge shot
Hit the edge.

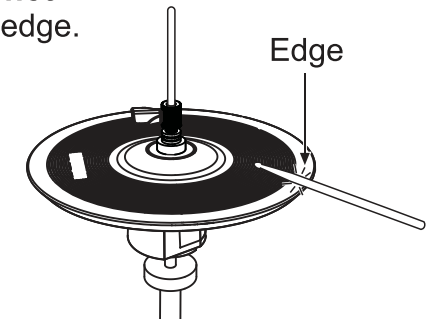

Choke

Choke the cymbal's edge with the hand immediately after hitting the cymbal will mute the sound. The choke function only works when you grasp in the area.

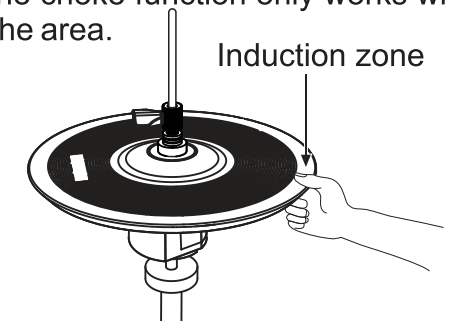

* HH Ctrl

Open Hi-hat
Hit the hi-hat without pressing the hi-hat pedal

Half-open Hi-hat
Hit the hi-hat with the hi-hat pedal in the half-open position.

Close Hi-hat
Hit the hi-hat with the hi-hat pedal pressed.

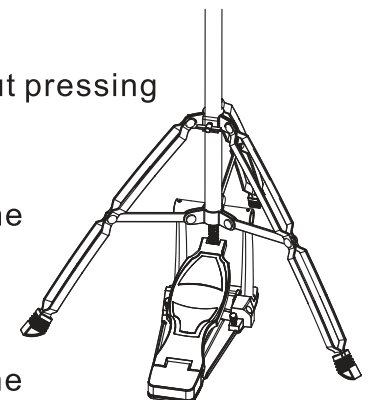

Function Operation

* TONE adjustment

1. Click the [TONE] button on the panel to enter tone editing mode.

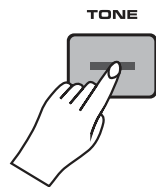

2. Under this mode, you can adjust the tone, pitch, and volume of individual components, or switch between the drum head/rim and the cymbal bow/edge for adjustment.

<p>SOUND MODIFY SN [i...]</p> <p>HEAD</p> <p>INSTRU: SNARE 05</p> <p>Adjust Tone</p>	<p>SOUND MODIFY SN [i...]</p> <p>HEAD</p> <p>PITCH: +23</p> <p>Adjust Pitch</p>
<p>SOUND MODIFY SN [i...]</p> <p>HEAD</p> <p>LEVEL: +23</p> <p>Adjust Volume</p>	<p>SOUND MODIFY SN [i...]</p> <p>HEAD</p> <p>SPLIT: ON</p> <p>Adjust Head/Rim</p>

3. Use [-] or [+] to adjust the parameter values and use the [ENTER] button to switch the parameter content that needs to be adjusted. Use [RETURN] button to return.

* COACH

1. Click the [COACH] button on the panel to enter the coaching function.



2. After entering COACH MENU, select your desired practice with the [-] or [+] button and press [ENTER] to enter.

COACH MENU

ACCENTS SHIFT

TIME CHECK

QUIET COUNT

CHANGE UP

3. After entering the selected practice, start the countdown of the preparatory shots, and after the preparatory shots, begin the practice exercise.
4. In any coach function type interface, press [CLICK] button to enter the coach function metronome adjustment interface; Alternatively, press [MENU] button to enter the parameter adjustment of the coaching function.

ACCENTS SHIFT

COACH CLICK	COACH CLICK
TEMPO 182	VOLUME 78
SOUND 1	

ACCENTS SHIFT	ACCENTS SHIFT
ACCENTS	RHYTHM
4-1	4TH
SCORE 8BAR	

TIME CHECK

COACH CLICK	COACH CLICK
TEMPO 182	VOLUME 78
BEAT 4	
RHYTHM 1	
SOUND 1	

TIME CHECK	TIME CHECK
SHARE	FINISHED!
BEHIND GOOD AHEAD	SCORE: 90
...% KICK 4-1	
SCORE 8BAR	
DISPLAY 1 KICK	
DISPLAY 2 SNARE	
GAUGE LEFT BEHIND	

QUIET COUNT

COACH CLICK	COACH CLICK
TEMPO 182	VOLUME 78
BEAT 4	
RHYTHM 1	
SOUND 1	

QUIET COUNT	QUIET COUNT
4-4	4-4
READY... 4-1	QUIET 4-1
FINISHED!	MEASURES 16
SCORE: 90	QUIET 2

CHANGE UP

COACH CLICK	COACH CLICK
TEMPO 182	VOLUME 78
BEAT 4	
SOUND 1	
VOLUME A	

CHANGE UP	CHANGE UP
CHANGE UP	CHANGE UP
READY... 4-1	FINISHED! 4-1
CHANGE UP	CHANGE UP
CHANGE UP	DURATION 20MINS
4-1	CHANGE-UP MEASURES 8

* Recording function

1. Click the [REC] button on the panel to enter the recording function.

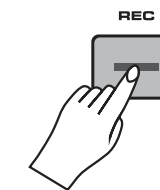

2. After entering the recording function, hit any drum to start recording.

<p>KT [i...]</p> <p>RECORDING</p> <p>RECORD READY?</p> <p>HIT DRUM PAD!</p>	→	<p>KT [i...]</p> <p>RECORDING</p> <p>11 00:02...</p>
-----------------------------------------------------------------------------	---	------------------------------------------------------

3. After stopping playing for 3 seconds, the recording ends. Press [PLAY/STOP] button to play/stop the previous recording.

<p>KT [i...]</p> <p>RECORDING</p> <p>RECORD COMPLETE!</p>	→	<p>KT [i...]</p> <p>RECORDING</p> <p>RECORD PLAY!</p>
-----------------------------------------------------------	---	-------------------------------------------------------

System Settings

* HIHAT SET

1. Click the [MENU] button on the panel to enter the menu, select via [-] or [+] button, and press [ENTER] button to enter the HIHAT SET interface.

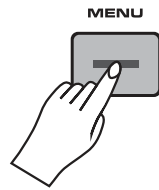

2. In the HIHAT SET interface, adjust the parameter values via [-] or [+] button, and switch parameter items through the [ENTER] button.
3. The DM-310H HIHAT is divided into three stages: closed, half open, and fully open.
4. HH SENS adjusts the sensitivity of the pedal, ranging from 0 to 127.
5. The interval between OP and CL in the figure is a half open range, which can be adjusted through HH OPEN VAL and HH CLOSE VAL. OP above is full open, CL below is closed.



* CLICK

1. Click the [MENU] button on the panel to enter the menu, select through [-] or [+] button, and press [ENTER] button to enter the CLICK interface.

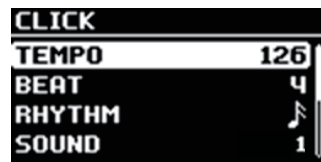

2. In the CLICK interface, adjust the parameter values through [-] or [+] button, and switch parameter items through the [ENTER] button.

Parameter control table		
Name	Range	Function
TEMPO	40-280	Speed
BEAT	1-9	Beats
RHYTHM	4th/8th/16th/ triplet	Notes
SOUND	7 kinds of sounds	Metronome tone
VOLUME	0-127	Metronome volume

* EFFECT

1. Click the [MENU] button on the panel to enter the menu, select through [-] or [+] button, and press [ENTER] button to enter the EFFECT interface.



2. In the EFFECT interface, select the effect type through [-] or [+] button and press the [ENTER] button to enter.
3. In a single effect, adjust the parameter values through [-] or [+] button, and switch parameter items through the [ENTER] button.

MASTER EQ

EFFECT KT [1-...]
MASTER EQ

EFFECT KT [1-...]
MASTER EQ OFF
+15
0
-15
100 400 1K 4K 12K

MASTER COMP

EFFECT KT [1-...]
MASTER COMP

EFFECT KT [1-...]
MASTER COMP OFF
THRE. GAIN ATTACK RELE.

OVER DRIVE

EFFECT KT [1-...]
OVER DRIVE

EFFECT KT [1-...]
OVERDRIVE OFF SEND FX 100
HG
STYLE OD TONE LEVEL

REVERB

EFFECT KT [1-...]
REVERB

EFFECT KT [1-...]
REVERB OFF SEND FX 100
PLATE
STYLE DECAY LEVEL

* TRIGGER

1. Click the [MENU] button on the panel to enter the menu, select through [-] or [+] button, and press [ENTER] button to enter the TRIGGER interface.



2. In the TRIGGER interface, adjust the parameter values through [-] or [+] button, and switch parameter items through the [ENTER] button.

Parameter control table		
Name	Range	Function
PAD TYPE	PAD/ CYMBAL	This function only takes effect after using the expansion component. If the expansion component is a cymbal, select CYMBAL with a choke function; If it is a drum pad, select PAD.
SENSITIVITY	1-99	Adjusts the sensitivity of the pad.
THRESHOLD	1-99	Adjusts the trigger level of the pad.

As shown on the right, the B waveform will sound and the A and C waveforms will not occur.

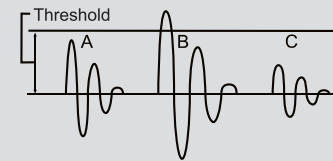

Note: If the value you set is too high, a light blow will not sound.

SCANTIME	1-8MS	Adjusts the detection time of the trigger signal.
----------	-------	---------------------------------------------------

When setting, try a soft and powerful blow and confirm the natural change in volume.

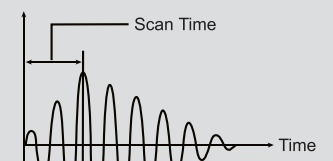

Note: If the value you set is too high, the sounding time will be lengthened. Please set as low as possible.

MASKTIME	4-64MS	Adjusts the masking time of the trigger signal.
----------	--------	-------------------------------------------------

Note: When playing fast, too high values may mask the trigger signal, so lower the value as much as possible.

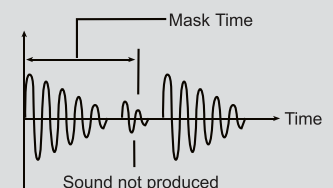

CURVE	LINEAR/ EXP/LOG/ LOUND	
RETRIG CANCEL	0-99	Adjusts the repeat value of the trigger signal.
XTALK CANCEL	0-80	Adjusts the cross-talk value.
RIM GAIN	1-99	Adjusts the edge gain, only effective for the drum rim and cymbal edge.
HEAD/RIM ADJUST	1-99	This parameter adjusts the relationship between the head and rim(also bow and edge).

! Note:

During the adjustment process, the most used parameters are SENSITIVITY adjustment and RIM GAIN adjustment. When you need to adjust the sensitivity of the drum pad, adjust it through SENSITIVITY. When you need to adjust the rim sensitivity, adjust it through RIM GAIN. The adjustment of the cymbal bow and edge also applies to SENSITIVITY and RIM GAIN.

* PANNING

1. Click the [MENU] button on the panel to enter the menu, select through [-] or [+] button, and press [ENTER] button to enter the PANNING interface.

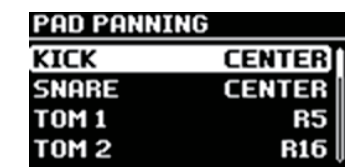

2. In the PANNING interface, adjust the parameter values through [-] or [+] button, and switch parameter items through the [ENTER] button.

* KIT NAME

1. Click the [MENU] button on the panel to enter the menu, select through [-] or [+] button, and press [ENTER] button to enter the KIT NAME interface.



- In the KIT NAME interface, adjust the letter through [-] or [+] button, and switch character through the [ENTER] button.

* OUTPUT

- Click the [MENU] button on the panel to enter the menu, select through [-] or [+] button, and press [ENTER] button to enter the OUTPUT interface.

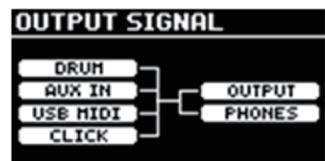

- In the OUTPUT interface, change the output mode through [-] or [+] button.

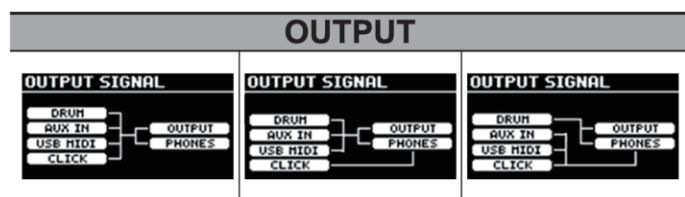

* MIDI NOTE

- Click the [MENU] button on the panel to enter the menu, select through [-] or [+] button, and press [ENTER] button to enter the MIDI NOTE interface.

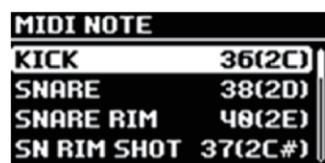

- In the MIDI NOTE interface, adjust the parameter values through [-] or [+] button, and switch parameter items through the [ENTER] button.

* RESET

- Click the [MENU] button on the panel to enter the menu, select through [-] or [+] button, and press [ENTER] button to enter the RESET interface.



- In the RESET interface, select the reset mode with the [-] or [+] button and confirm the factory reset with the [ENTER] button.

Parameter control table	
RESET CURRENT KIT	Clear current kit data and load factory preset.
RESET ALL KIT	Clear all kit data and load factory preset.
RESET SYSTEM	Clear system data and load factory preset.
RESET ALL	Clear all data and load factory preset.

* OPTION

- Click the [MENU] button on the panel to enter the menu, select through [-] or [+] button, and press [ENTER] button to enter the OPTION interface.



- In the OPTION interface, adjust the parameter values through [-] or [+] button, and switch parameter items through the [ENTER] button.

Parameter control table		
Name	Range	Function
MIC. GAIN	OFF/1-10	Adjust the microphone gain of the phone interface. Default is off.
CONTRAST	1-10	Adjusts the screen's contrast.
MIDI OUT CH.	1-16	MIDI out channel.
ME. LOCK	Lock/unlock	Memory lock.
SYSTEM INFO.	/	System information.
BLUETOOTH	ON/OFF	Bluetooth switch (only displayed after connecting the Bluetooth module).

* USB AUDIO/USB MIDI

- Use a USB cable to connect the DM-310H to the computer. After the connection is successful, the USB icon on the screen will light up.
- The DM-310H module is an audio/MIDI recording interface, with the ability to send stereo audio and MIDI data to a Mac or Windows computer (windows users need to the download the ASIO driver from DM-310H website) via a single USB cable. This lets you record discrete audio and MIDI drum tracks in any DAW, or trigger sounds in software-based drum instruments for studio or live playing.

Note: You need to select NUX DM-310H as the input device on the DAW's input device to record multi-track audio. DM-310H USB audio support 8 multi-track recording on any DAW.

* BLUETOOTH

- The DM-310H package comes with the NUX Bluetooth module NBT-1. Before using Bluetooth, please connect the NBT-1 to the DM-310 module.

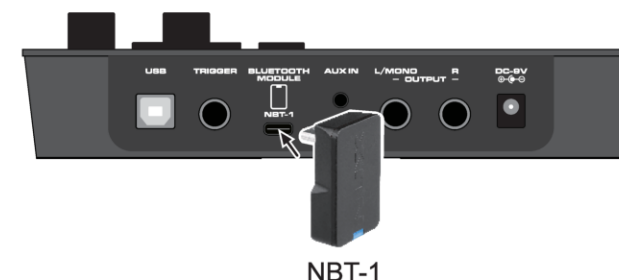

- Set BLUETOOTH to ON from the OPTION interface under the MENU before using the Bluetooth function normally.



* AUX IN

- * When you need to use this function, please use 1/8" TRRS cable.



- Connect the mobile phone/iPad to the DM-310H module through the AUX IN interface.
- Use the recording APP on the mobile phone/iPad, click the recording button on the mobile phone and start playing, the audio content of the performance will be recorded into the mobile phone/iPad.

* External trigger input

- The DM-310H module supports an external trigger, which allows you to connect a drum pad or cymbal to the TRIGGER interface.

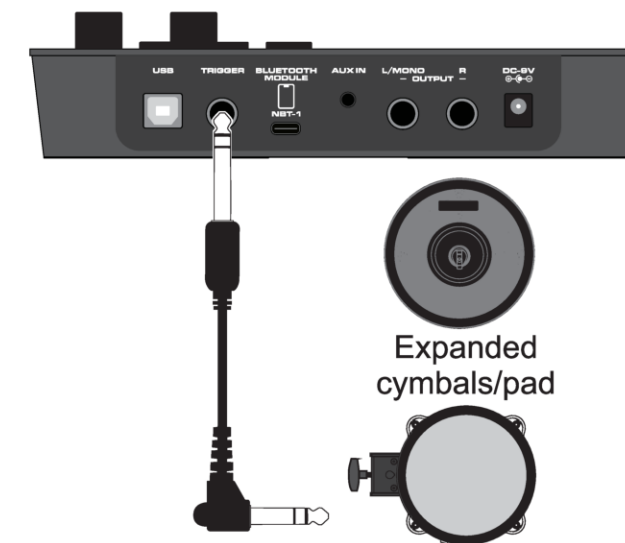

- After connecting the drum/cymbal, select the PAD TYPE to the corresponding component in the TRIGGER interface under MENU. DRUM is selected for the drum pad, and CYMBAL is selected for the cymbal pad. Once the tone is assigned, it can be used.



Specification

- **Display:** Dot-matrix display
- **Drum set:** 25 Presets, 10 Users
- **Effect:** Master EQ, Master compressor, Over drive, Reverb
- **Coach:** Accents shift, Time check, Quiet count, Change up
- **Pads:** 10" Snare x 1, 10" Tom x 1, 8" Tom x 2, 12" Cymbal x 3, 14" Cymbal x 1, Kick x 1
- **USB:** USB audio, USB MIDI
- **Interface:** USB, Trigger, BLUETOOTH module, Aux in, OUTPUT L/MONO, OUTPUT R, DC in, Phones
- **Power:** DC 9V external positive and internal negative,
The working current is less than or equal to 280 mA

*Specifications and features are subject to change without notice.

NUX has grandly launched its brand - new tone processing technology, **VariTone™**. With its groundbreaking algorithm and powerful computing performance, it deeply integrates a high - quality tone sample library. This technology can not only accurately capture the subtle differences in the striking positions but also exquisitely reproduce the authentic tones and dynamic responses of traditional drum kits, bringing users an immersive acoustic drum playing experience.

CAUTION

This device complies with part 15 of the FCC Rules. Operation is subject to the following two conditions: (1) this device may not cause harmful interference, and (2) this device must accept any interference received, including interference that may cause undesired operation. Any changes or modifications not expressly approved by the party responsible for compliance could void the user's authority to operate the equipment.

NOTE: This equipment has been tested and found to comply with the limits for a Class B digital device, pursuant to Part 15 of the FCC Rules. These limits are designed to provide reasonable protection against harmful interference in a residential installation. This equipment generates, uses and can radiate radio frequency energy and, if not installed and used in accordance with the instructions, may cause harmful interference to radio communications. However, there is no guarantee that interference will not occur in a particular installation.

If this equipment does cause harmful interference to radio or television reception, which can be determined by turning the equipment off and on, the user is encouraged to try to correct the interference by one or more of the following measures:

- Reorient or relocate the receiving antenna.
- Increase the separation between the equipment and receiver.
- Connect the equipment into an outlet on a circuit different from that to which the receiver is connected.
- Consult the dealer or an experienced radio/TV technician for help.

The device has been evaluated to meet general RF exposure requirement. The device can be used in portable exposure condition without restriction.

According to the technical specifications of low-power radio frequency equipment:

For low-power radio frequency equipment that has been certified, companies, firms, or users are not allowed to change the frequency, increase the power, or change the characteristics and functions of the original design without approval. The use of low-power radio frequency equipment must not affect flight safety and interfere with legal communications; if interference is found, it should be stopped immediately and improved to no interference before continuing to use. The aforementioned legal communication refers to radio communication operated in accordance with the provisions of the Telecommunications Administration Law. Low-power radio frequency equipment must endure the interference of legal communications or industrial, scientific and medical radio wave radiation electrical equipment.

Environment temperature 0-40 degree.