



 **KIRSTEIN.de**  
We love music!



## excellent sound

- Sauerstofffreies Kupfer
- Hochdichter Kupferschild
- Hochflexibler und robuster Außenmantel
- Handgelötet
- Säure- und ölfest
- Spannzangen und Zugentlastung
- Niedrige Leiterkapazität
- 3 Jahre Garantie
- Oxygen free copper
- High density copper shield
- Highly flexible and durable
- Soldered by hand
- Acid and oil proof
- Chuck type strain relief
- Low capacitance
- 3 years warranty



Cet appareil  
se recycle

À DÉPOSER  
EN MAGASIN

À DÉPOSER  
EN DÉCHÈTERIE



OU



FR



Points de collecte sur [www.quefairedemesdechets.fr](http://www.quefairedemesdechets.fr)  
Privilégiez la réparation ou le don de votre appareil !

# MXW70

Manual Generated: 12/07/2025 - 16:33



## Table of Contents

<b>MXW70</b> .....	3
<b>Introduction</b> .....	3
<b>What's included with the MXW70?</b> .....	4
<b>Front panel</b> .....	5
<b>Rear panel connections</b> .....	6
<b>Getting connected</b> .....	8
<b>Power syncing</b> .....	10
<b>Mono connection</b> .....	11
<b>Advanced settings</b> .....	13
<b>Protection circuitry</b> .....	14
<b>Troubleshooting</b> .....	16
<b>Technical specification</b> .....	17

## **MXW70**

Last updated: June 17, 2025 11:08. Revision #14408

### **Introduction**

Last updated: June 10, 2025 01:44. Revision #14539

Last updated: May 16, 2025 05:04. Revision #10022

This guide is designed to make installing and using this product as easy as possible. Information in this document has been carefully checked for accuracy at the time of printing; however, Cambridge Audio's policy is one of continuous improvement, therefore design and specifications are subject to change without prior notice.

This document contains proprietary information protected by copyright. All rights reserved. No part of this manual may be reproduced by any mechanical, electronic or other means, in any form, without prior written permission of the manufacturer. All trademarks and registered trademarks are the property of their respective owners.

©Copyright Cambridge Audio Ltd 2025.

For upcoming news on future products, software updates and exclusive offers, make sure you register your product at <https://www.cambridgeaudio.com/register>

## What's included with the MXW70?

Last updated: June 10, 2025 01:43. Revision #14530

**Inside the box of your MXW70 you will receive:**

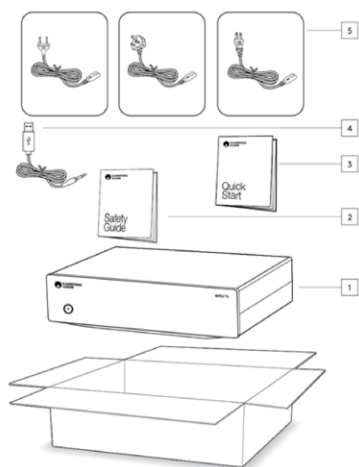

1. MXW70 Power Amplifier
2. Quick start guide
3. Safety guide
4. Trigger in Cable
5. UK power cord (Depending on which country the MXW70 was purchased in) EU power cord (Depending on which country the MXW70 was purchased in) CU power cord (Depending on which country the MXW70 was purchased in) JP power cord (Depending on which country the MXW70 was purchased in)

## Front panel

Last updated: June 10, 2025 01:44. Revision #14531

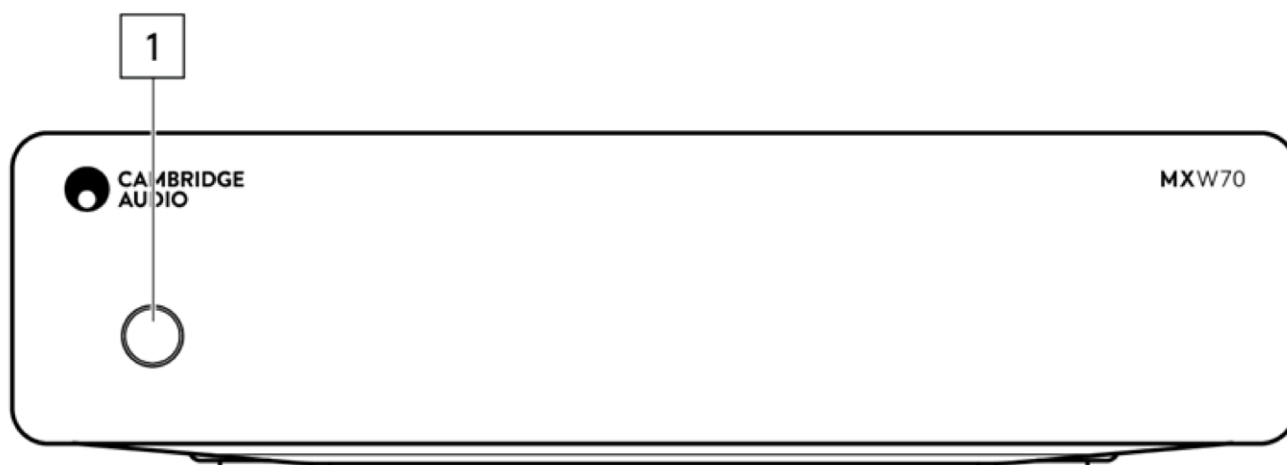

### 1. Power button

Switches the unit between Standby Mode (indicated by dim power LED) and On (indicated by bright power LED). Standby Mode is a low power mode (0.5 Watts) - The unit should be left in Standby Mode when not in use.

### AUTO POWER DOWN (APD)

The product will automatically switch to standby mode after inactivity of 20 minutes. To enable or disable this function, Refer to the "Auto Power Down (APD)" section of this manual for more information.

## Rear panel connections

Last updated: June 10, 2025 01:44. Revision #14532

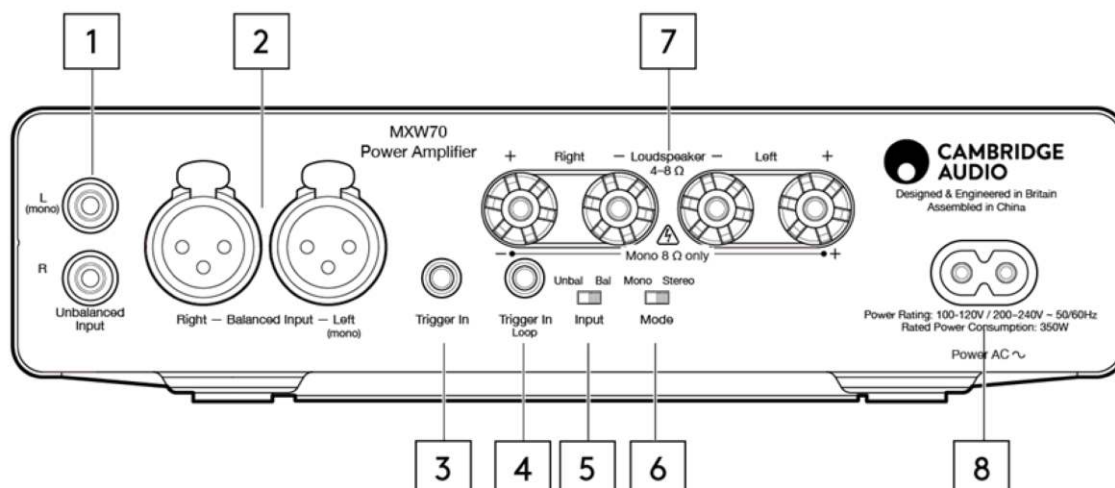

### 1. Unbalanced input.

RCA input is unbalanced.

Note: in mono mode, only the left (mono) channel needs to be connected, the Mode switch must be set to the “Mono” mode, Refer to the 'Mono connection' section of this manual for more information.

### 2. Balanced Input

For use with balanced XLR connections. The balanced connection is recommended for long distances (>2m) as it helps reject noise and interference in the cable when used with other equipment that supports XLR out .

Note: in Mono mode, only the left (mono) channel needs to be connected, the Mode switch must be set to the “Mono” mode.

### 3. Trigger in

The MXW70 can be connected to the trigger control output of audio or home automation equipment to control the power state of the MXW70. The input level should be 12V.

### 4. Trigger loop

The trigger loop will transfer the 12V from the Trigger in, this can be used to turn on a second MXW70 or another device.

Refer to the 'Power syncing' section of this manual for more information.

### 5. Unbalanced/Balanced input source switch - Select depending on whether a source is connected to the balanced XLR or unbalanced RCA input.

Note: There will be no sound from the amp if the correct input isn't selected. If a source is connected to the balanced input, for example, ensure that the balanced switch has been selected.

### 6. Speaker-output Mode switch (Mono/Stereo)

the Mode switch toggles the Mono or Stereo mode.

### 7. SPEAKER TERMINALS

Note: When using a banana plug, make sure the speaker terminals are completely tightened before inserting the plug.

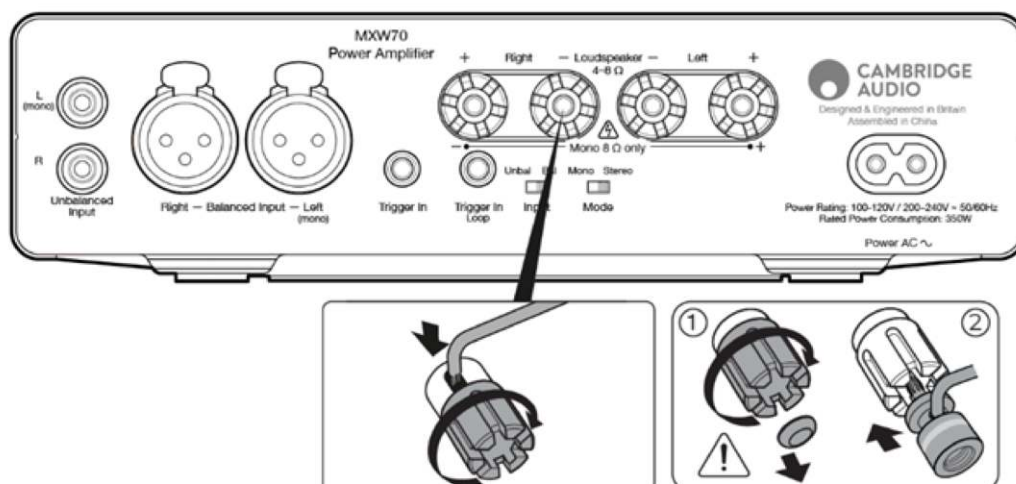

### In Stereo mode

Connect the wires from your left channel loudspeaker to the left positive and negative terminals and the wires from the right channel loudspeaker to the right positive and negative terminals. The red terminal is the positive output and the black terminal is the negative output.

Care should be taken to ensure no stray strands of wire short the speaker outputs together. Please ensure that the loudspeaker terminals have been tightened completely to provide a good electrical connection. It is possible for the sound quality to be affected if the screw terminals are loose.

### In Mono mode

NOTE: the red terminal of the "Left" is the positive output, the red terminal of the "Right" is the negative output.

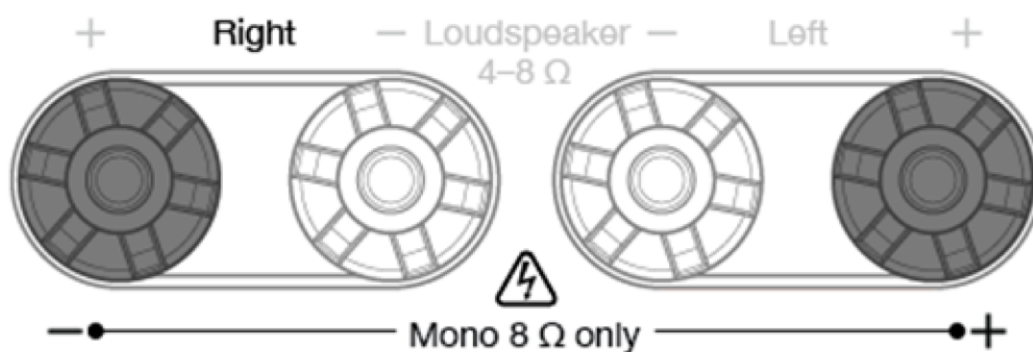

### 8. AC POWER SOCKET

Once you have completed all connections to the amplifier, plug the AC power cable into an appropriate mains socket then switch on. Your amplifier is now ready for use.

## Getting connected

Last updated: June 10, 2025 01:44. Revision #14533

### LOUDSPEAKERS

Check the impedance of your speakers. You can use types with an impedance of between 4 and 8 Ohms in stereo mode. Only 8ohm loudspeaker is supported in mono mode.

The red coloured speaker terminals are positive (+) and the black speaker terminals are negative (-). Make sure the correct polarity is maintained at each speaker connector or the sound can become weak and "phasey" with little bass.

Note: in the Mono mode, the red terminal of the "Left" is the positive output, the red terminal of the "Right" is the negative output.. refer to the 'Mono connection' section of this manual for more information.

### USING BARE WIRE CONNECTIONS

Prepare the speaker cords for connection by stripping off approximately 10mm (3/8") or less of the outer insulation. More than 10mm could cause a short circuit. Twist the wires tightly together so there are no loose ends. Unscrew the speaker terminal, insert the speaker cable, tighten the terminal and secure the cable.

Note: All connections are made using standard loudspeaker cable.



### USING BANANA PLUGS

We recommend using Banana plugs with our units to establish a secure connection and ensure there are no loose strands of wire that may cause unwanted noise or interference.

Once you have stripped the outer insulation of the cable and twisted the wires as indicated below, securely connect these to your banana plugs and push the plug in as far as possible without applying excessive force.

Note: When using a banana plug, make sure the speaker terminals are completely tightened before removing the "pip" from them, and then insert the banana plugs

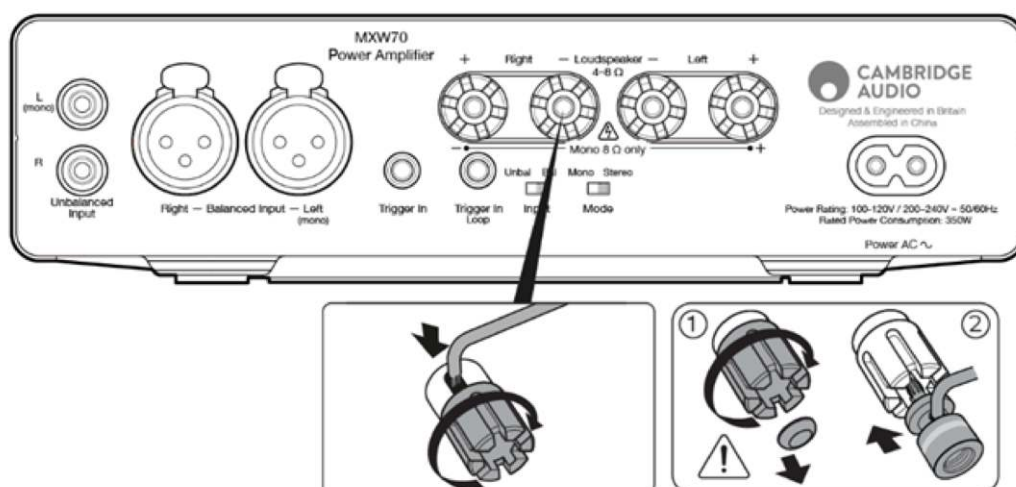

### STEREO CONNECTIONS

The analogue inputs are to be connected to the Pre-Outs of a Preamplifier or Integrated amp. The diagrams below show the basic connection from a Preamplifier.

### Unbalanced input

Using RCA cables will enable an unbalanced analogue connection to your MXW70. If using RCA cables, ensure the 'Unbalanced' switch on your MXW70 is selected.

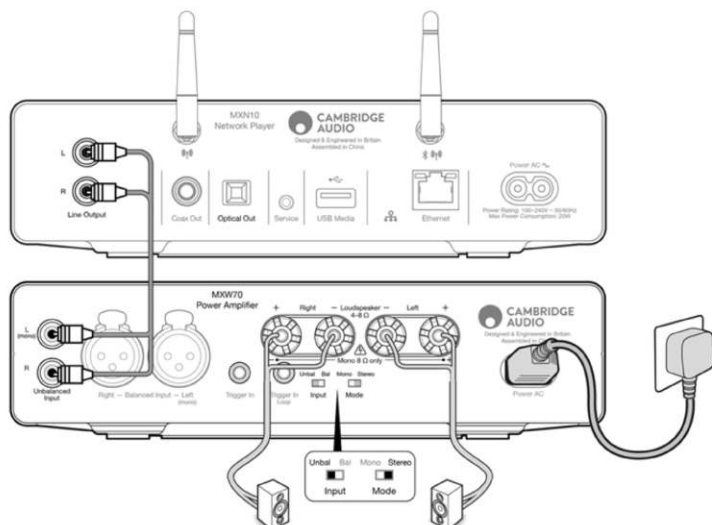

### Balanced input

Using XLR cables will enable a balanced analogue connection to your MXW70. This will provide a cleaner signal path compared to an RCA unbalanced connection, especially over longer cable lengths, however the increase in audio quality they provide is subjective when used over shorter lengths.

If using XLR cables, ensure the 'Balanced' switch on your MXW70 is selected.

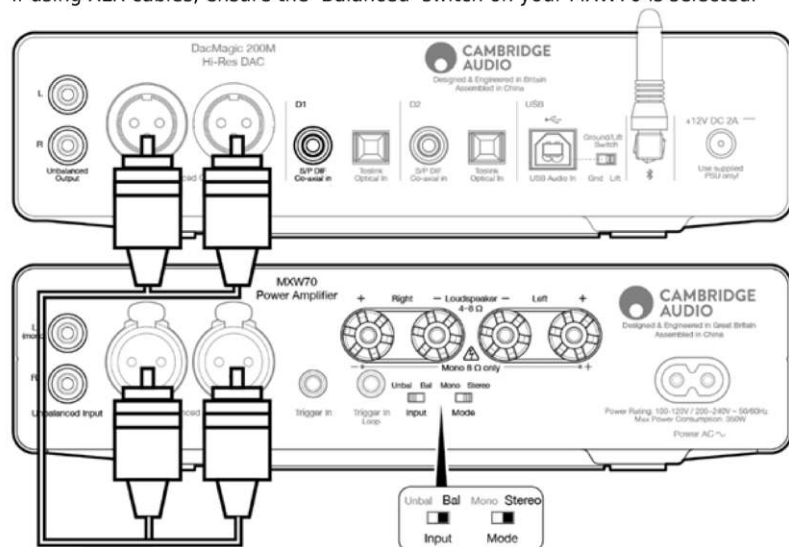

# Power syncing

Last updated: June 10, 2025 01:44. Revision #14534

## TRIGGER IN

The MXW70 is supplied with a Trigger in cable that connects to any audio product's USB A port, allowing MXW70 to synchronize power on/standby. When you turn your product On/Off, the MXW70 will also power on/off. The diagram below shows how to use Trigger in cable between the MXN10 and MXW70.

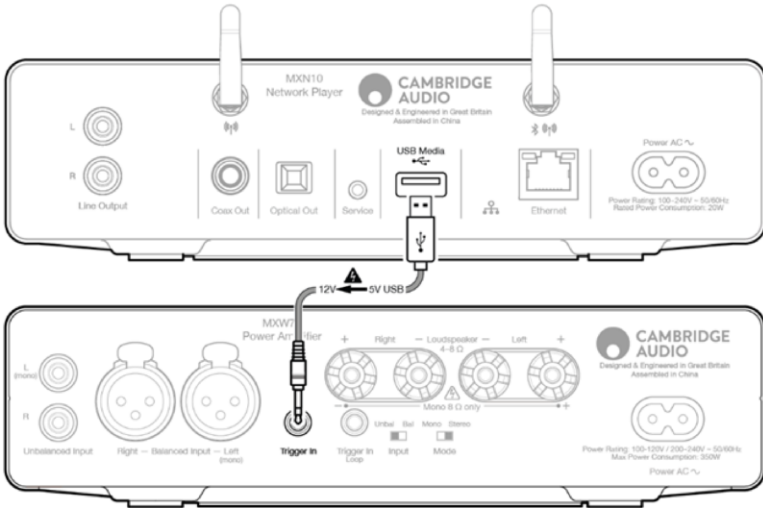

## TRIGGER IN LOOP

The trigger loop will pass the 12V from the Trigger in, so this can be used to turn on the second MXW. A standard 3.5mm jack cable (mono or stereo) can be used for the purpose.

NOTE: Trigger In Loop is different from a Trigger Out connection. MXW70 does not generate 12V on Trigger In Loop. An external source connected to Trigger In is required to use Trigger In Loop

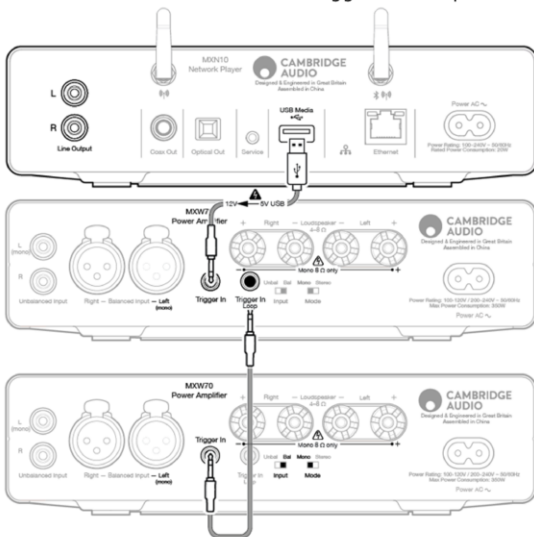

For the trigger in cable, avoid connecting to any other ports, as it can damage the unit.

# Mono connection

Last updated: June 10, 2025 01:45. Revision #14535

Mono mode allows you to drive the left speaker by one power amplifier and the right speaker by another power amplifier.

**⚠ Power Amplifiers must be controlled by a product in pre-amp (variable output) mode. Otherwise you risk maximum volume output which may damage your speakers.**

## Unbalanced connection in mono mode

1. The diagram below shows how to drive a pair of MXW70's connected to a MXN10 using an unbalanced connection.
2. In the Mono mode, only 8ohm is supported and the red terminal of the "Right" is the negative output.
3. Turn on the Pre-Amp mode in the StreamMagic app, to ensure the volume increases/decreases in sync.
4. Set the Mode switch in Mono mode and ensure that the unbalanced switch has been selected.

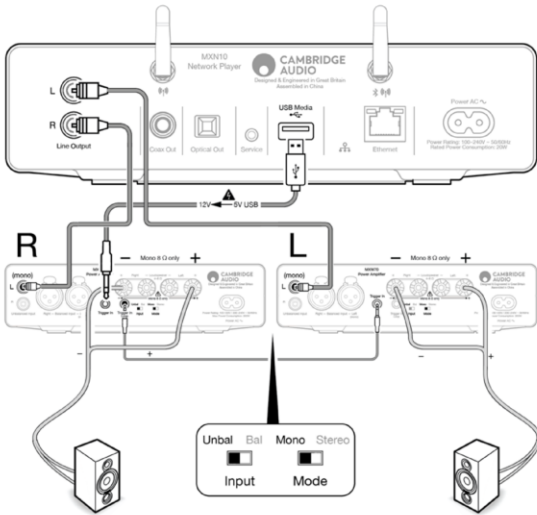
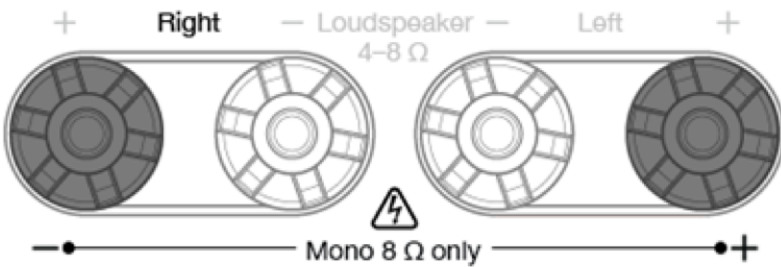

## Balanced connection in mono mode

The diagram below shows how to drive a pair of MXW70's connected to a DacMagic200M using the balanced connection. the Mode switch in Mono mode and ensure that the balanced switch has been selected.

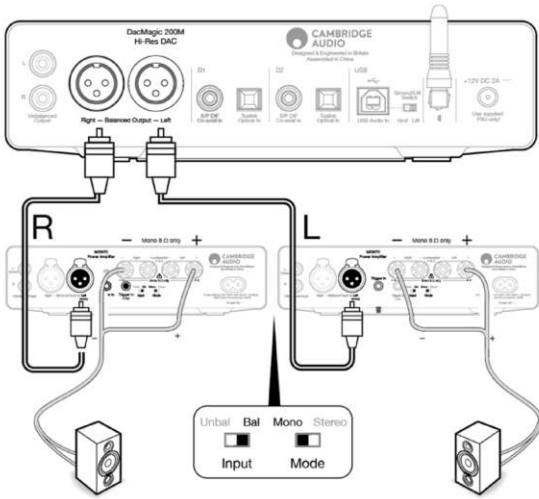

## Advanced settings

Last updated: June 10, 2025 01:45. Revision #14536

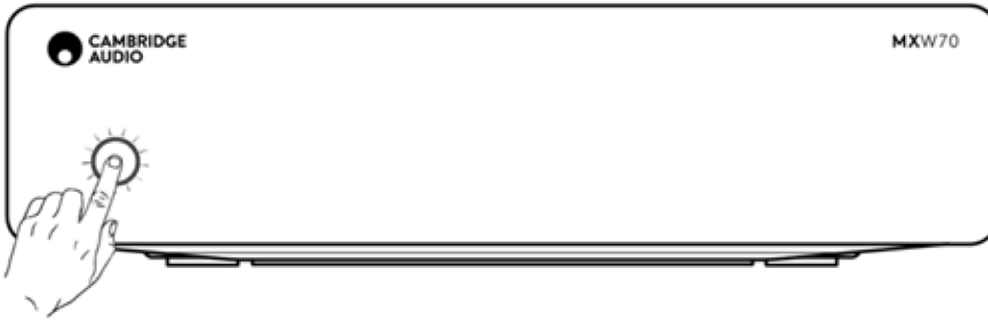

### Auto Power Down (APD)

The MXW70 arrives with APD enabled, and this will automatically switch the unit to standby if no audio signal is detected for 20 minutes. To disable, or re-enable this function then please see the below instructions.

#### Disable APD

Note: Please ensure that the MXW70 is in standby, which is indicated by only the standby LED being dim .

Press and hold the Standby button for 5 seconds.

Will blink alternately red-white LED for five times and then go back to the standby state

#### Enable APD/To perform a factory reset

Note: Please ensure the AC power cable of MXW70 is unplugged and wait for the standby LED to turn off before plugging in the AC power to perform APD reset or factory reset.

#### Enable APD (default)

Press and hold Standby button for 5 seconds while plugging in AC power

Will blink alternately red-white LED for five times and then go back to the standby state

#### To perform a factory reset

Press and hold standby button while plugging in AC power until blink alternately red-white LED.

\* APD function will enable.

## Protection circuitry

Last updated: June 10, 2025 01:45. Revision #14537

The MXW70 includes Amplifier Protection Circuitry to detect faults with Over Temperature, DC offset, Clipping and Power supply fault. If any of these faults are detected the button LED will blink red.

Press the button once to disable the protection indication, and press again to turn unit back on, when the fault has been removed.

### DC



This is indicated by 1 short red blink followed by solid white.

MXW70 offers loudspeaker protection if the output of the amplifier goes to a high constant voltage (DC) because of some internal fault. This is a rare fault, although detecting it will protect your loudspeakers from damage.

If this fault occurs, please contact your dealer for service or our support team <https://www.cambridgeaudio.com/contact>

### Over Temperature



This is indicated by 2 short red blinks followed by solid white

Over temperature can be caused by a combination of high listening levels, low impedance speakers and insufficient ventilation. If the internal temperature reaches a high level, the amplifier will automatically switch into a fault mode to protect itself from damage.

If the loudspeaker impedance is low, the temperature of the amplifier may rise faster as the amplifier is working harder. If the amplifier is mounted in a closed cabinet, the over temperature detection may activate/reactivate after a short listening time.

Leave the unit for 5 minutes to cool down before resuming normal operation. Check if the loudspeaker impedance is suitable for the selected MXW70 operation mode, and also make sure there's at least 15cm room all around the unit to allow the necessary convection cooling.

The unit will not resume operation even when pressing the standby button if the internal temperature hasn't reached a safe level yet.

### Power Supply Fault



This is indicated by 3 short red blinks followed by solid white.

In the unlucky event that the internal power supply becomes faulty. this can also happen when removing the power cord whilst unit is on, or if there's a sudden power outage.

If the issue persists, please contact your dealer for service or our support team <https://www.cambridgeaudio.com/contact>

### Clipping



This is indicated by 4 short red blinks followed by solid white.

The unit will allow output clipping for a very short time, as this might occasionally happen during loud music transients. Red light will flash quickly. In this case it is recommended to reduce the volume of the source.

If clipping condition is persistent, then the unit will automatically shutdown to prevent loudspeaker damage.

# Troubleshooting

Last updated: June 10, 2025 01:45. Revision #14538

## There is no power

- Ensure the AC power cord is connected securely.
- Ensure the plug is fully inserted into the wall socket and is switched on.
- Check fuse in the mains plug or adaptor.

## There is no sound

- Make sure the unit is not in Standby mode.
- Check that source component is properly connected.
- Check that your speakers are properly connected.
- Ensure that the correct input has been selected via the Balanced/Unbalanced switch.
- Ensure that the correct mode has been selected via the Mono/Stereo switch.
- If possible, use different interconnect cables and speaker cables.
- Check your source devices' volume control to ensure this is not muted.
- Check with alternative source device.

## There is no sound on one channel

- Check speaker connections.
- Check interconnects.

## There is weak bass or diffused stereo imaging

- Ensure that speakers are not wired out of phase.

## There is a loud buzz or hum

- Ensure no interconnects are loose or defective.

## The LED standby button is flashing red

- Check the 'Protection Circuitry' section for troubleshooting steps.

## Technical specification

Last updated: June 10, 2025 01:46. Revision #14529

Last updated: June 10, 2025 05:05. Revision #10014

### Continuous power output:

- 2 x 70W RMS into 8 Ohms
- 2 x 125W RMS into 4 Ohms
- 1 x 250W RMS into 8 Ohms (Mono)

### THD (unweighted):

- <0.015% @ 5W/8ohm

### Frequency Response:

- 10Hz - 30kHz (-1dB)

### S/N ratio (ref 1W into 8 Ohm):

- >110dB (20-20k bw)

### Crosstalk @ 1kHz:

- <-82dB

### Inputs:

- Balanced, Unbalanced.
- 12v Trigger

### Input sensitivity:

- 3.6V (mono XLR), 1.65V (mono RCA), 0.9V (stereo RCA), 1.9V (stereo XLR)

### Outputs:

- Speakers, 12v Trigger Loop out

### Max power consumption:

- 300W

### Standby power consumption:

- <0.5W

### Dimensions:

- 56 x 215 x 215mm

### Weight:

- 1.65kg

# DacMagic 200M

Manual Generated: 30/04/2024 - 12:06



## Table of Contents

<b>DacMagic 200M</b> .....	3
<b>Introduction</b> .....	3
<b>What's included with the DacMagic 200M?</b> .....	4
<b>Front panel controls</b> .....	5
<b>Rear panel connections</b> .....	6
<b>Getting connected</b> .....	7
<b>Master Quality Authenticated (MQA)</b> .....	12
<b>Filters</b> .....	13
<b>Advanced settings</b> .....	16
<b>Auto Power Down (APD)</b> .....	17
<b>TV mode</b> .....	18
<b>Frequently asked questions</b> .....	19
<b>Technical specifications</b> .....	20

## DacMagic 200M

Last updated: April 29, 2024 02:12. Revision #12645

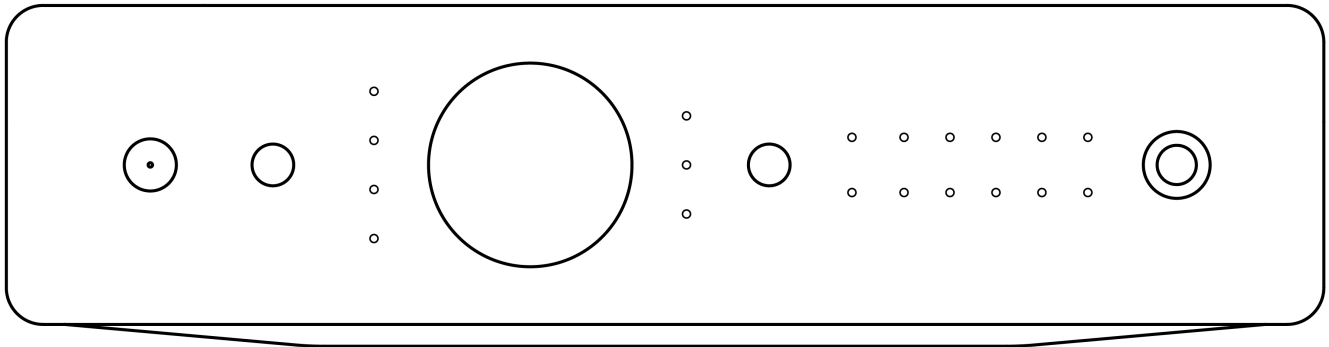

Users Manual

## Introduction

Last updated: May 24, 2022 02:34. Revision #4385

This guide is designed to make installing and using this product as easy as possible. Information in this document has been carefully checked for accuracy at the time of printing; however, Cambridge Audio's policy is one of continuous improvement, therefore design and specifications are subject to change without prior notice.

This document contains proprietary information protected by copyright. All rights are reserved. No part of this manual may be reproduced by any mechanical, electronic or other means, in any form, without prior written permission of the manufacturer. All trademarks and registered trademarks are the property of their respective owners.

The Bluetooth® word mark and logos are registered trademarks owned by the Bluetooth SIG, Inc. and any use of such marks by Audio Partnership Plc is under license. Other trademarks and trade names are those of their respective owners.

MQA and the Sound Wave Device are registered trademarks of MQA Limited © 2016.

© Copyright Cambridge Audio Ltd

For upcoming news on future products, software updates and exclusive offers, make sure you register your product at <http://www.cambridgeaudio.com/register>

## What's included with the DacMagic 200M?

Last updated: June 7, 2022 08:18. Revision #4561

**Inside the box of your DacMagic 200M you will receive:**

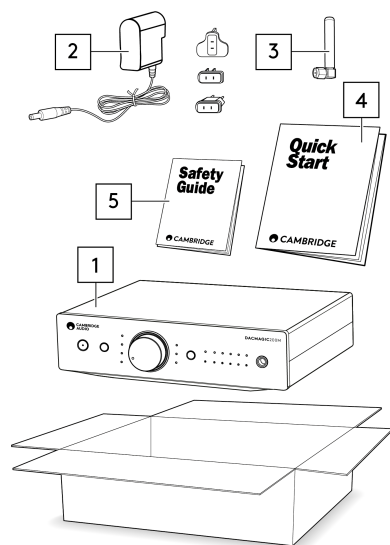

1. DacMagic 200M Digital to Analogue Converter
2. 12V Power Supply
3. Bluetooth antenna
4. Quick Start Guide
5. Safety Instructions

## Front panel controls

Last updated: June 6, 2022 10:50. Revision #5874

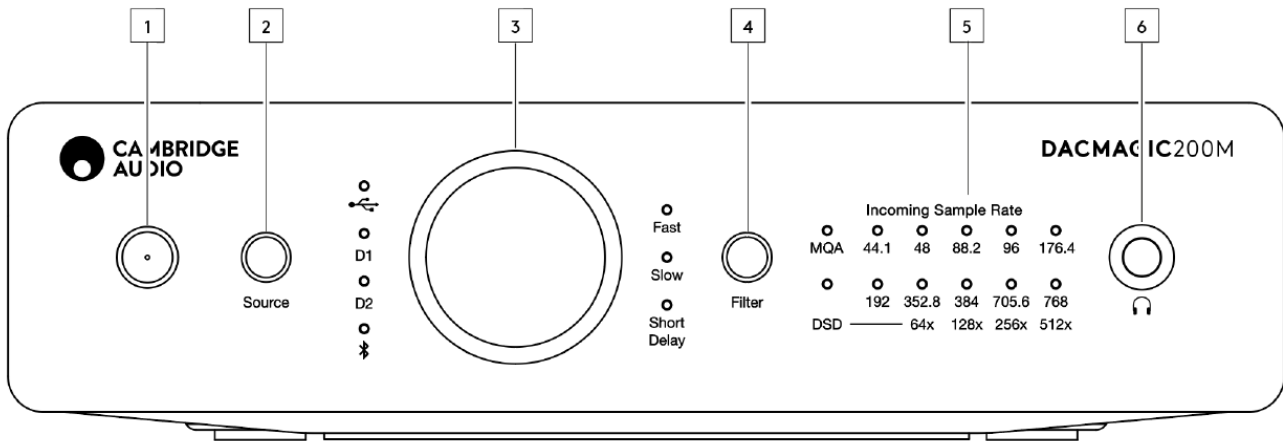

### 1. Standby/On - Switches the unit between on and low power standby.

**2. Source** - Select incoming audio source. Toggle between USB, Digital Inputs 1, and 2, and Bluetooth. The selected input will be indicated by the corresponding LED.

**3. Digital volume control** - Adjust the volume when Digital Preamp (variable) mode is enabled. Pressing this knob will result in a mute toggle.

**4. Filter** - Press to select between three different filter modes: Fast, Slow, and Short Delay. This selected filter mode will be indicated by the corresponding LED.

**5. Incoming sample rate** - When the DacMagic 200M is receiving an incoming digital stream, the relevant LED will light up to indicate the incoming digital sampling frequency. For MQA the LED will light up green for MQA, or blue for MQA Studio. If the LED is magenta, then the unit is rendering an MQA stream or file, completing the processing, and allowing playback at the highest possible audio quality. DSD will light up when native DSD or DoP streams are detected.

**Note:** The sample rate LEDs reflects the incoming sample rate, and not that of the original source.

**6. Headphone connection** - Allows the connection of headphones for a direct listening experience.

## Rear panel connections

Last updated: June 1, 2022 08:48. Revision #5875

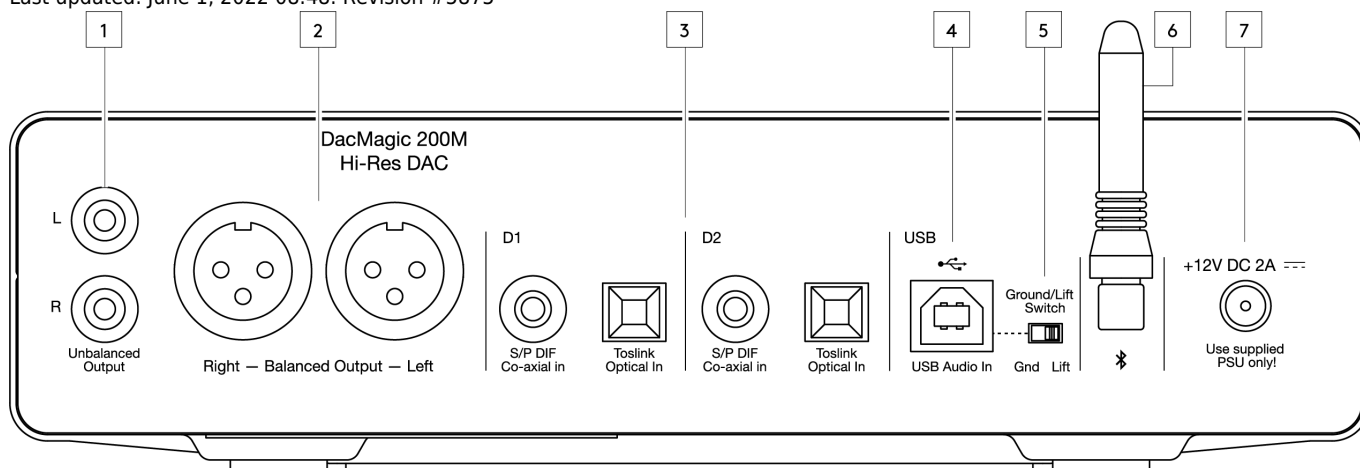

**1. Unbalanced audio outputs** – Outputs for use with unbalanced RCA cables.

**2. Balanced audio outputs** – Outputs for use with balanced XLR cables. Suitable for when a longer connection is needed between the DacMagic 200M, and an amplifier.

**3. Digital inputs 1 and 2** – The DacMagic 200M offers two digital inputs allowing a wide range of sources to be connected via the use of S/P DIF co-axial, or TOSLINK optical.

**4. USB audio in** – For connecting to PC/Mac computers for USB Class 2.0 Audio playback. Please note that for Windows devices the Cambridge Audio USB Audio driver must be installed.

**5. Ground/Lift switch** – When connected to a PC via USB, and with the switch set to ‘ground’, the DacMagic 200M will ground itself via the USB connection. Setting the switch to ‘lift’ will ground the device via an internal network to reduce hum in case of ground loops.

**6. Bluetooth antenna** – Used for the wireless streaming of Bluetooth audio from most phones, tablets, and laptops.

**7. DC 12V 2.0A power adaptor socket** – Note: Only use the power supply included with the DacMagic 200M.

## Getting connected

Last updated: June 1, 2022 08:50. Revision #5877

### Initial setup

1. Connect your chosen digital audio source(s) to the input(s) on the DacMagic 200M via:

**TOSLINK optical** - which offers high quality transfer over shorter distances

OR

**S/P DIF coaxial** - which can be used for longer connections

OR

**USB audio** to connect to a PC, or Mac.

2. Connect the audio outputs to the line-input of your amplifier using the unbalanced RCA connections for shorter distances, or the balanced XLR connections for longer distances.
3. Using the appropriate plug for your region, connect the supplied power adaptor to the DacMagic 200M.
4. Power on the unit and select the input source that you wish to listen to using the source button located on the front panel.

**Note:** For Bluetooth connections, please follow the instructions from the Bluetooth section of the manual.

#### If there is no power to the unit, please see the following steps

1. Check that the supplied 12V PSU is securely connected to the power adaptor socket on the rear of the DacMagic 200M.
2. Confirm that the PSU is securely connected to the mains socket, and that the socket is switched on.

#### If a hum or buzzing sound can be heard after setup, please see the following steps

1. Check that all connections between **Source(s) > DacMagic 200M > Amplifier** are secure.
2. Move the unit away from any nearby lighting, or mains cables that could cause interference.
3. If connected to a PC or Mac via USB, switch 'Ground Lift' switch to 'lift'.

## Audio output connections

### Balanced connection to a CXA81

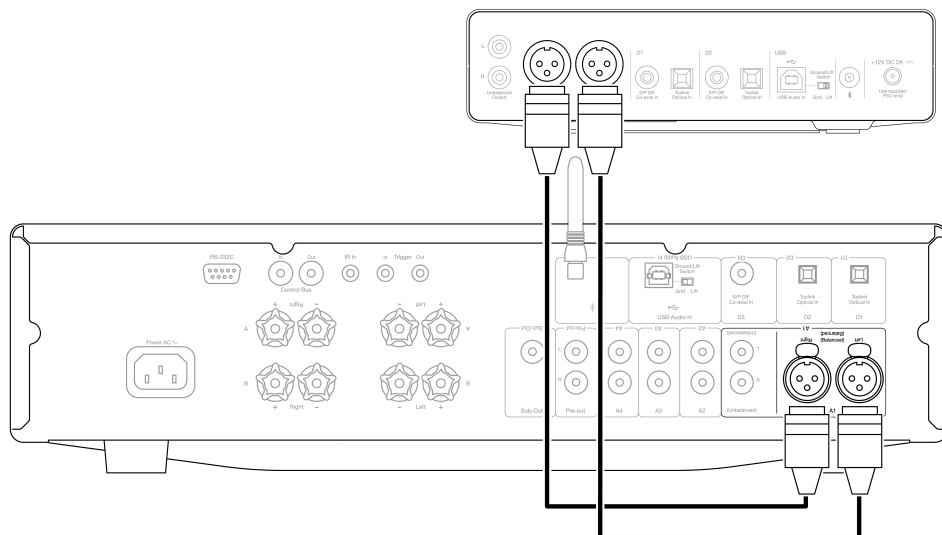

### Unbalanced connection to a CXA81

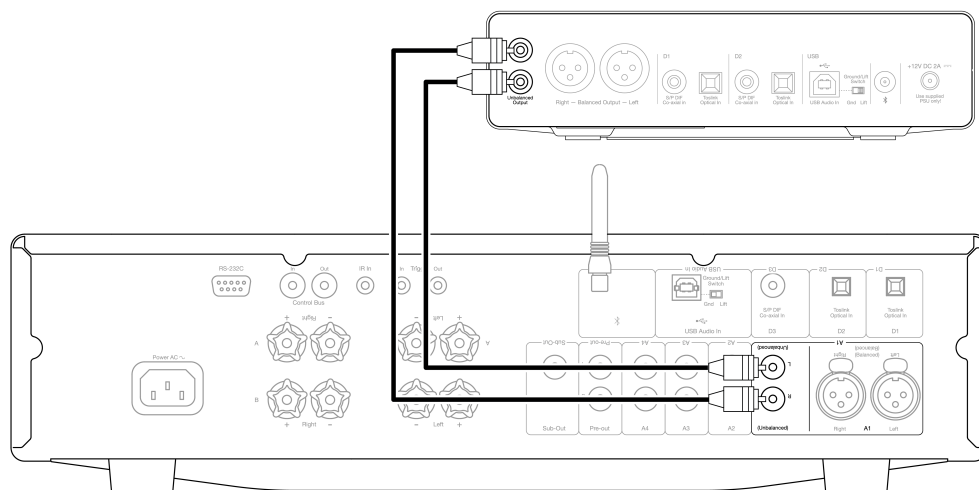

**Note:** Do not turn the unit on until all necessary connections have been made.

The DacMagic 200M offers both balanced (XLR), and unbalanced (RCA) audio output connections.

In the case of longer connections between the DacMagic 200M and your amplifier we would recommend the use of a balanced connection via XLR as this can help to reject noise, and interference in the cable.

It is possible to use both balanced, and unbalanced connections at the same time, for example: when connecting to multiple amplifiers, or a multi-room setup.

## Digital audio input connections

### Connection to a CXC using S/P DIF coaxial

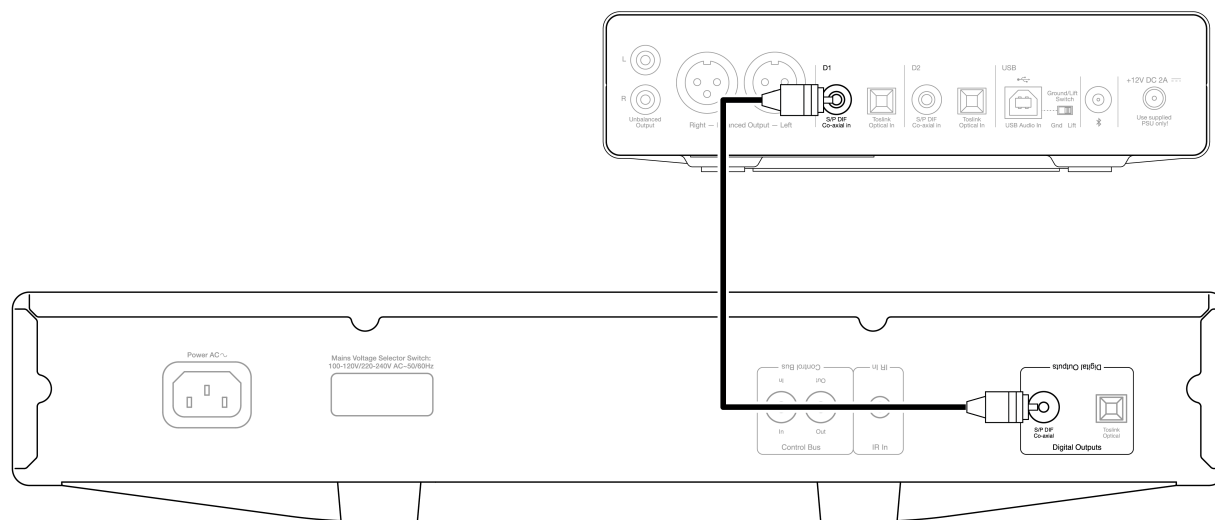

## Connection to a Smart TV using TOSLINK optical

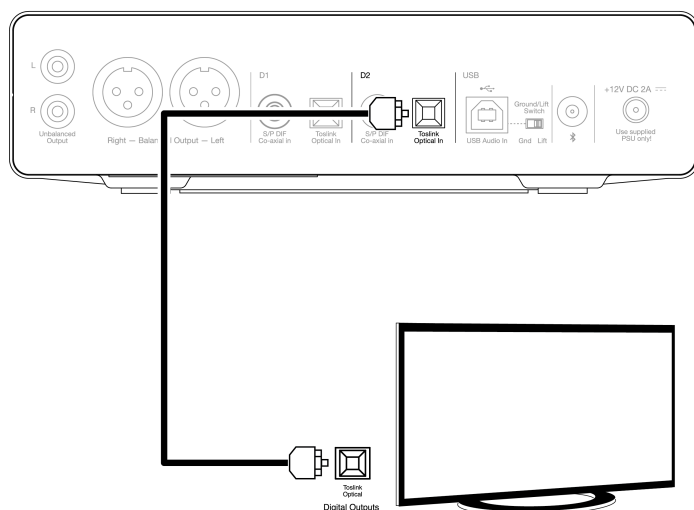

**Important Note:** Only connect one co-axial OR optical cable to each digital input. The unit will not operate properly if both connections are made (even if only one is active).

This unit only accepts two-channel LPCM/Stereo PCM digital audio, and cannot be used with Dolby Digital 5.1, or DTS signal. If connecting a DVD/BD player, a smart TV or similar device please ensure that the output is set to two-channel PCM.

If there is no sound output once the input, and output connections have been made, please follow the steps below:

1. Check that the interconnects between the DacMagic 200M, and the amplifier are securely connected.
2. Confirm that the correct incoming source is selected via the corresponding LEDs on the front panel of the DacMagic 200M.

## USB audio connection

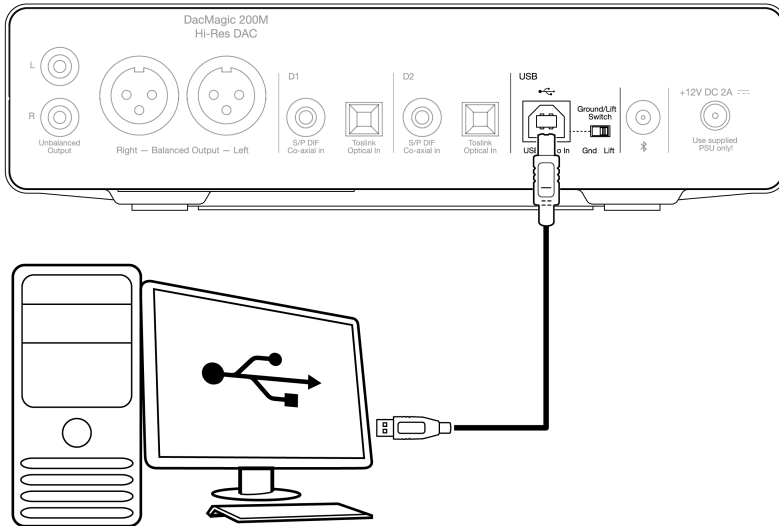

The DacMagic 200M only supports USB audio playback using USB Class 2.0 Audio. For this it is required that the DacMagic 200M is connected to a USB 2.0 port using a suitable USB cable, and we would recommend any USB certified high-speed USB 2.0 'A-B' cable.

## Use with Windows PCs

For use with Windows PCs, you will need to install the Cambridge Audio USB Driver to be able to play audio via USB Audio Class 2.0. More information regarding the download, and installation of the driver can be found here:

<https://techsupport.cambridgeaudio.com/hc/en-us/articles/207434895-Windows-Audio-USB-Class-2-Driver->

## Use with Mac

DacMagic 200M is compatible with Macs without the need for extra drivers.

## Use with Linux

Due to the many configuration options and target hardware, we cannot say that Linux is officially supported by the DacMagic 200M.

However, most recent Linux distros are supporting USB Audio Class 2.0 natively, so the DacMagic 200M should work without any specific action required.

## Ground/Lift switch

The DacMagic 200M includes a 'ground/lift' switch on the rear panel. When connected via USB, and with the switch set to 'ground', the DacMagic 200M will ground itself via the USB connection. Setting the switch to 'lift' will ground the device via an internal network to reduce any potential hum in case of ground loops.

The switch should be left in the "ground" position unless a hum or noise is heard from the system.

In some instances, the use of audio grade USB cables can cause compatibility issues, and the introduction of glitches. This is because the cable may not fully adhere to USB standards. If you are experiencing noise, hum, or glitches whilst connected via USB it may be necessary for you to set the switch to 'lift', which will disconnect the ground from the computer connection.

## Use with the Apple camera adapter

The DacMagic 200M is not designed for use with mobile devices via wired connection such as an iPhone using the Apple Camera Adapter, or an Android phone using a USB OTG adapter. Therefore, it is not possible for us to guarantee compatibility for a setup of this nature.

In most cases when attempting to use the DacMagic 200M with a mobile device, and an Apple Camera Adapter, the user will receive the

following alert: 'Cannot Use Accessory'.

## Bluetooth

Selecting Bluetooth with the source button located on the front panel allows the DacMagic 200M to receive wireless Bluetooth audio from most smartphones, tablets, and laptops.

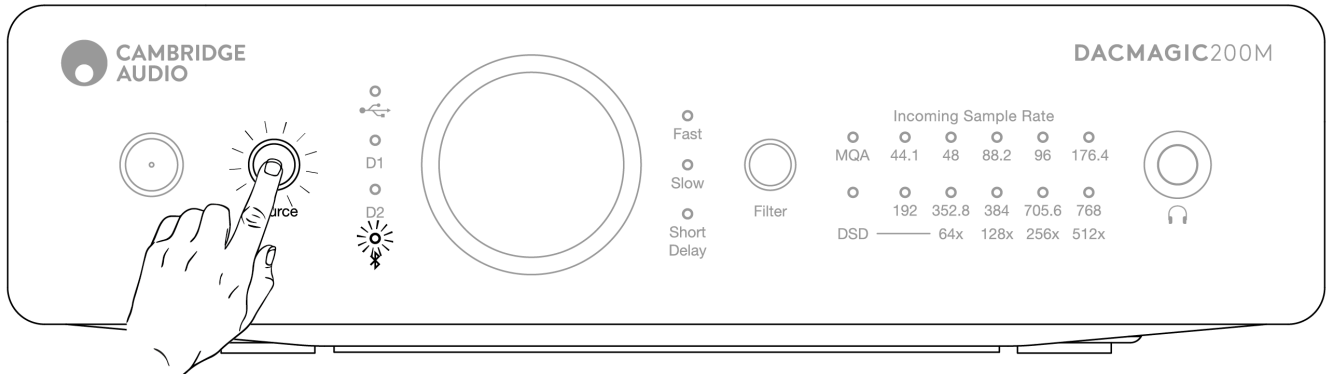

### Pairing

The following procedure will allow you to pair a new Bluetooth enabled device with the DacMagic 200M.

1. Make sure that any previously paired Bluetooth devices are turned off (the DacMagic 200M will auto-connect to the last paired device).
2. Turn on the DacMagic 200M and select Bluetooth as the source (denoted by the Bluetooth symbol).
3. Activate Bluetooth on the desired source device.
4. Scan for available devices on the source device and select 'DacMagic 200M'.

### Unpairing

To unpair a device you can select 'unpair' in the source unit's device list. Alternatively, you can perform a factory reset on the DacMagic 200M which will delete all previously paired devices.

**Note:** Your device can only be paired and connected to the DacMagic 200M whilst the Bluetooth source is selected.

### Paired LED status

Once your device is paired, the Bluetooth Source LED will change to denote the type of codec that is being received.

SBC Codec is represented by a solid light.

aptX Codec is represented with a 2-second solid light followed by a very short light off interval.

## Headphone

The DacMagic 200M integrates a dedicated headphone amplifier stage for a personal listening experience.

The volume can be adjusted with the front knob, and the volume level will be saved separately from the main output volume (if digital preamp mode is enabled).

Whilst headphones are connected the line out is disabled.

## Master Quality Authenticated (MQA)

Last updated: June 1, 2022 08:51. Revision #5878

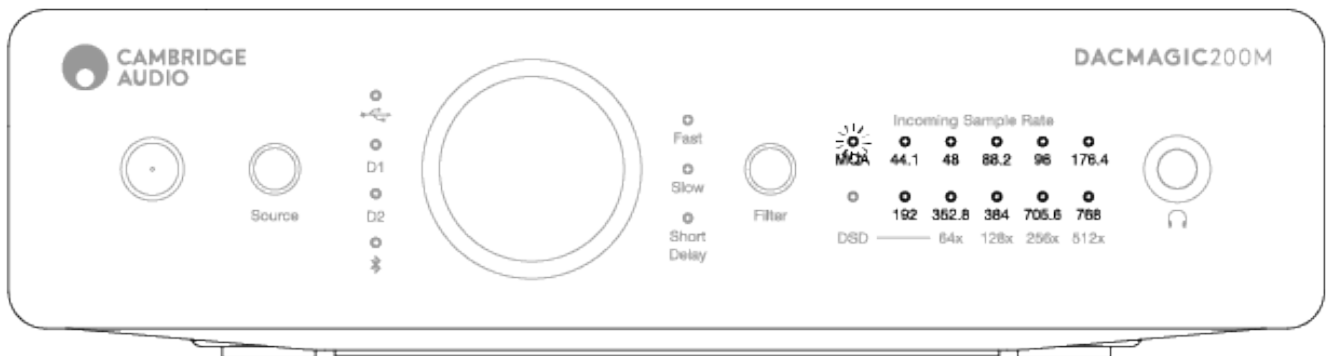

Master Quality Authenticated is an audio codec using a sophisticated compression algorithm, and a form of file authentication intended for high-quality audio streaming and file download. This allows the listener to receive digital audio at the original studio quality.

Using a unique 'origami' folding technique, the information is packaged efficiently to retain all the detail from the studio recording. Hardware or software with MQA decoding capability can 'unfold' the MQA file and reveal the original master resolution.

The file is also 'authenticated' to guarantee that it is the definitive master recording from the studio, artist or record label.

MQA tracks are delivered to the listener with all the required data for full studio quality hidden, or 'folded' within the file itself. This means with each unfold, more data is revealed for higher quality playback.

There are essentially four versions of MQA playback. And depending on how your system is configured, each will perform different unfolds to reveal more of the dormant information hidden within the file.

### No unfold

This is the raw folded MQA file that can be played back through any device as no decoding is required. This is typically better than CD quality at 44.1 or 48 kHz.

### MQA core decode

This is the point at which the first unfold takes place. The MQA Core Decoder authenticates, decodes full dynamic range, and matches to the current playback settings. This can be performed either within software (TIDAL, Audirvana, Roon) or hardware that contains a MQA Core Decoder, and at this point the file is upscaled to 88.2 or 96 kHz.

### MQA core decode with hardware rendering

In this method of playback, a combination of software and hardware is used to further unfold the file. As with MQA Core Decoding, the software decodes the MQA 24 bit / 44.1kHz file and unpacks it to 24 bit / 88.2 kHz. This file is then output to the hardware renderer where it is expanded up to 24 bit / 352.8 kHz.

### Full decode and MQA renderer

Full Decoding and MQA Rendering is only possible using hardware with MQA certification and is the optimum playback method of MQA files. This will require all stages of the unfold or processing to take place within the hardware, which is fed the untouched MQA file before performing the various decodes and rendering. This is typically the highest possible quality and files can be upscaled to a maximum resolution of 768 kHz.

The DacMagic 200M includes MQA technology and can perform full MQA decoding from all inputs except Bluetooth, enabling you to playback MQA audio files and streams delivering the same quality as the original master recording.

## Filters

Last updated: June 1, 2022 08:51. Revision #5879

The DacMagic 200M has three different digital filter functions: Fast, Slow and Short Delay. All three filters are highly sophisticated audiophile topologies, optimised specifically for audio playback. In our opinion, these filters offer excellent sound quality but differ subtly in optimisation, hence we've made all three available to you.

**Note:** For clarity, all diagrams show the theoretical response of the digital filter itself, excluding any analogue filtering at the DAC output or the antialiasing filter applied during recording and/or mastering of the digital source.

### Fast filter

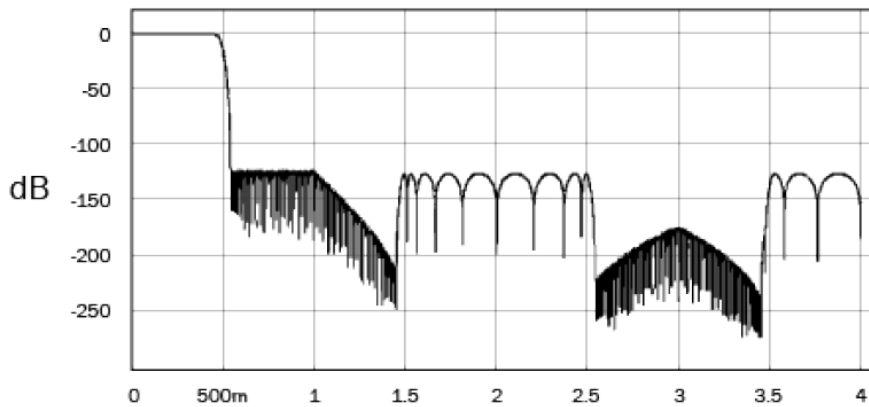

The Fast (Linear Phase) filter is a highly regarded audio filter offering low ripple in both the pass and stop bands, and what is known as constant group delay. Constant group delay means that audio signals of all frequencies are always delayed by the same amount when passing through the filter. All audio is therefore fully time-coherent at the output.

The trade-off with this type of filter is that its impulse response will exhibit some pre-ringing. In other words, when excited with a theoretical impulse, the output has both a small amount of pre- and post-spike amplitude ringing (albeit well damped).

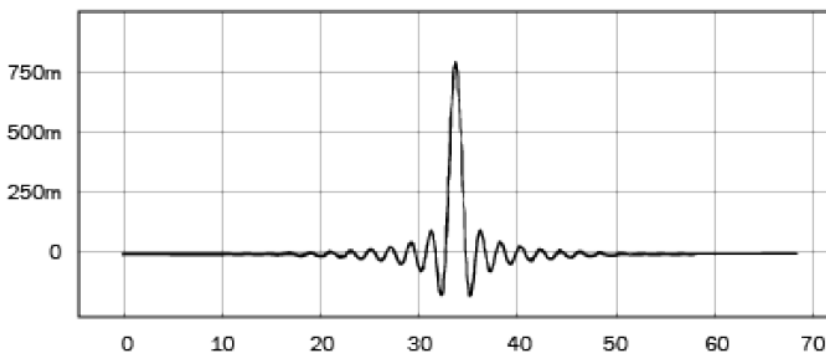

### Slow filter

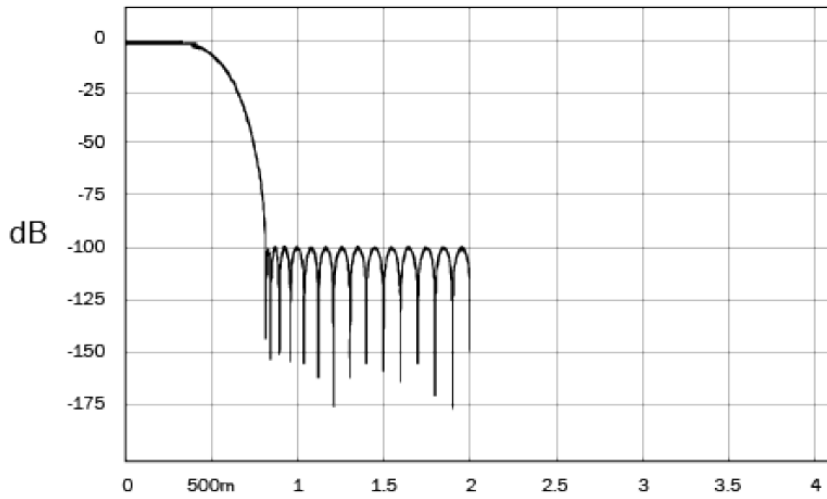

Our Slow filter has a linear phase and is a compromise between some very high frequency roll off and the minimized level of pre/post impulse ringing. Stop band attenuation is less than other filter types, but there's no phase shift and the impulse response is the cleanest.

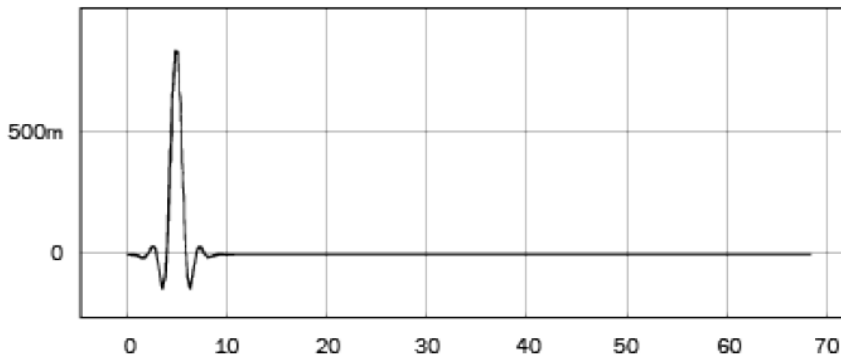

### Short delay filter

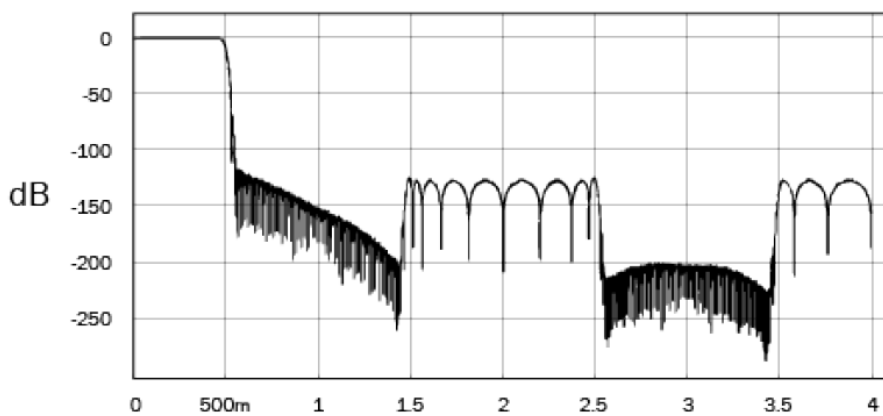

The Short Delay (minimum phase) filter is another highly regarded audio filter that offers even lower ripple in the pass and stop bands. Unlike the Linear Phase filter, group delay is not constant; however, phase shift is low and the particular benefit with this filter is that the impulse response exhibits no pre-ringing.

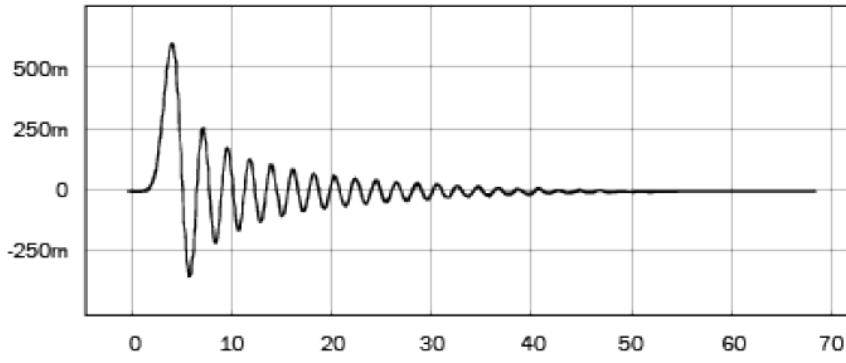

We encourage you to experiment with the filters to determine which sound best to your ears and using your source equipment/programme material. The DacMagic 200M remembers and recalls the selected filter type at power up.

**Note:** when reproducing MQA contents, the filters selection is disabled.

## Advanced settings

Last updated: June 1, 2022 08:52. Revision #5880

**Note:** Prior to performing any of the following procedures, please ensure that the DacMagic 200M is in standby, which is indicated by only the standby LED being lit.

### To perform a factory reset

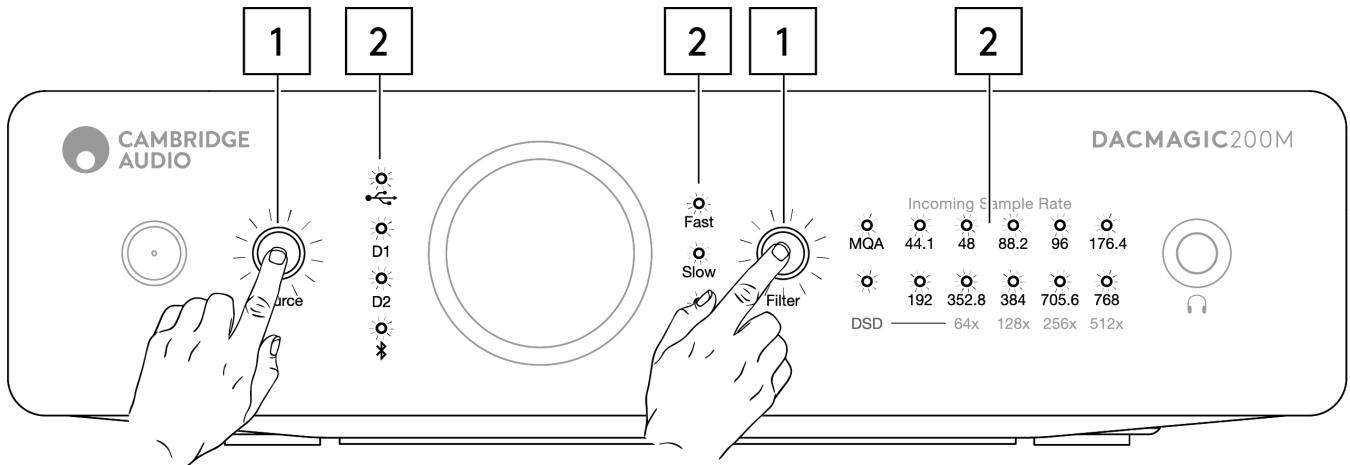

1. Briefly press both the Source and Filter buttons simultaneously.
2. All LEDs will light in sequence, one by one.

Upon performing a factory reset all user-stored settings (input, volume and output mode) will be erased, and replaced by the unit's default settings after a factory reset.

### Toggle between fixed, and variable output modes

The DacMagic 200M can be switched between a fixed output mode which disables the front panel volume control, and variable mode which enables the front panel volume control, allowing volume adjustment on the unit.

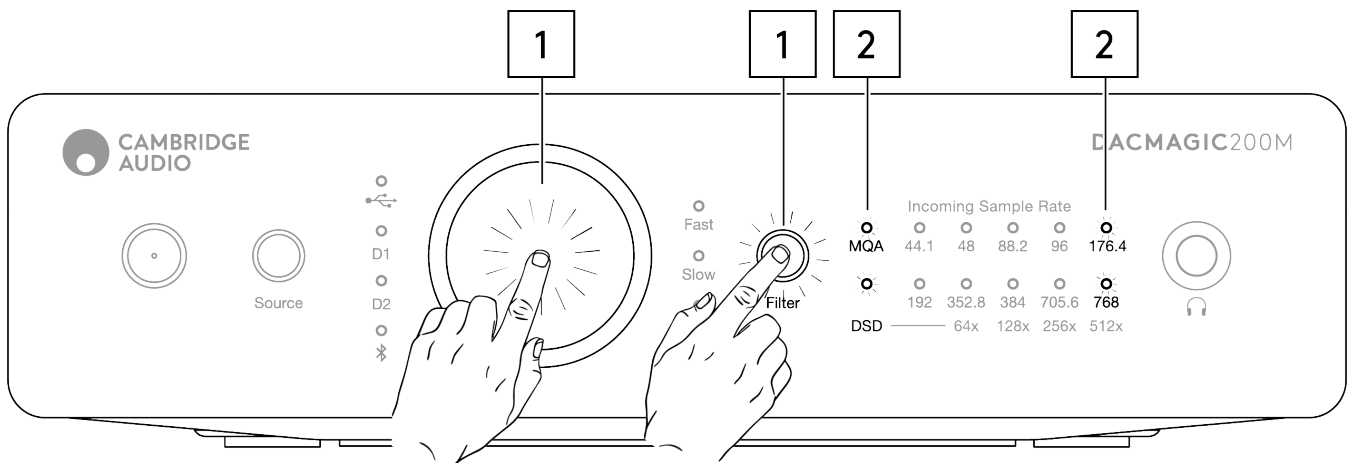

1. Briefly press the volume knob, and filter button simultaneously.
2. Two LEDs will light up to indicate the output mode.

RCA/XLR output set to fixed mode with volume knob disabled: MQA/DSD light up for 5s.

RCA/XLR output set to variable mode (default) with volume knob enabled: 176.4/768 LEDs light up for 5s.

**Note:** Headphone output is always variable.

## Auto Power Down (APD)

Last updated: June 1, 2022 09:47. Revision #4522

The DacMagic 200M arrives with APD enabled, and this will automatically switch the unit to standby after 20 minutes of inactivity.

To disable, or re-enable this function then please see the below instructions.

**Note:** The DacMagic 200M must be in standby which is indicated by only the standby LED being lit prior to completing the following procedure.

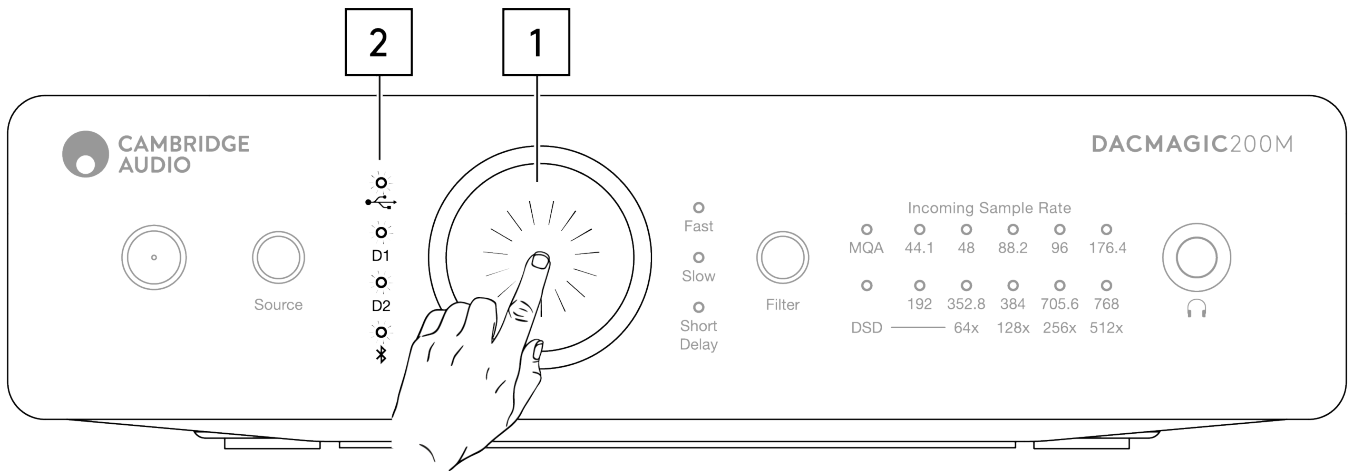

### APD Off

1. Press and hold down the Volume knob for 5 seconds.
2. Wait for the Input LEDs to blink 2 times.

### APD On (default)

1. Press and hold down the Volume knob for 10 seconds.
2. Wait for the Input LEDs to blink 5 times.

# TV mode

Last updated: June 6, 2022 10:49. Revision #4553

On later units, a switchable TV mode was introduced that improves the performance of the DacMagic 200M whilst using a TV as a source. This configures the DacMagic 200M with a higher bandwidth to reduce glitches and interruptions when connected to a TV.

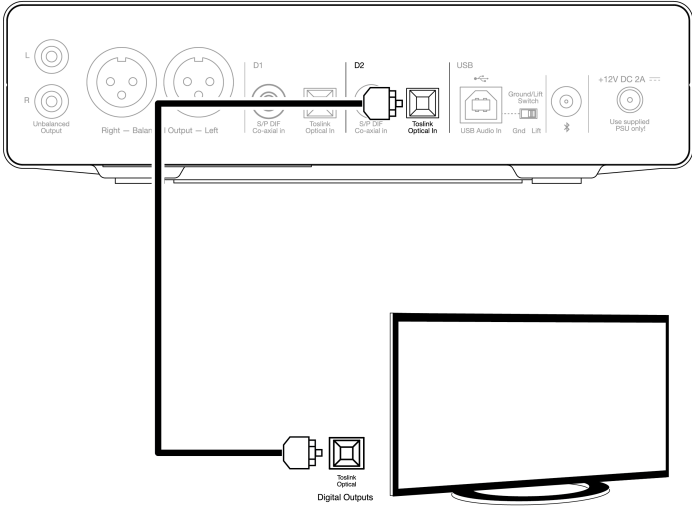

TV mode is only effective on the D2 input and can be enabled and disabled by following the instructions below.

1. With the DacMagic 200M in standby mode, long press the source button.
2. Two LEDs will light up to indicate the TV mode status.

### TV mode on enabled: 44.1/192 LEDs light up

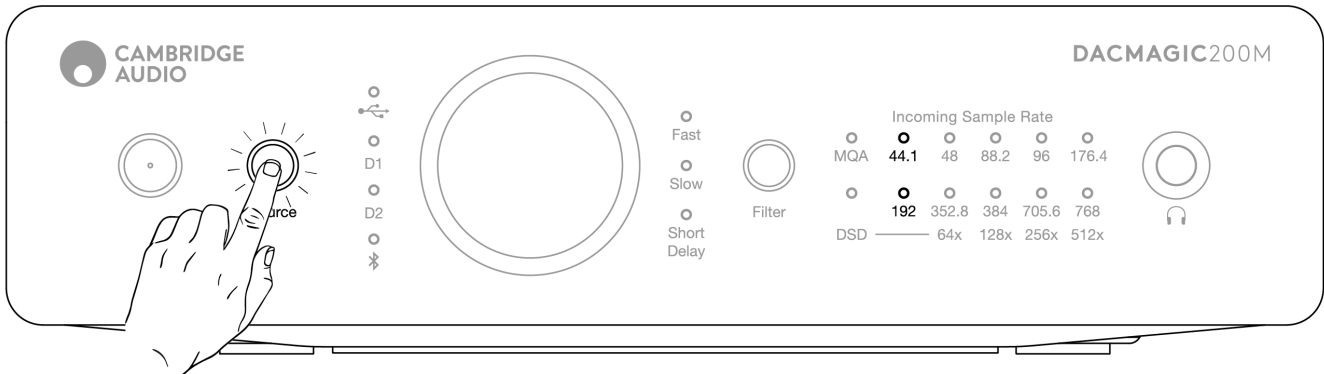

### TV mode disabled: 96/705.6 LEDs light up

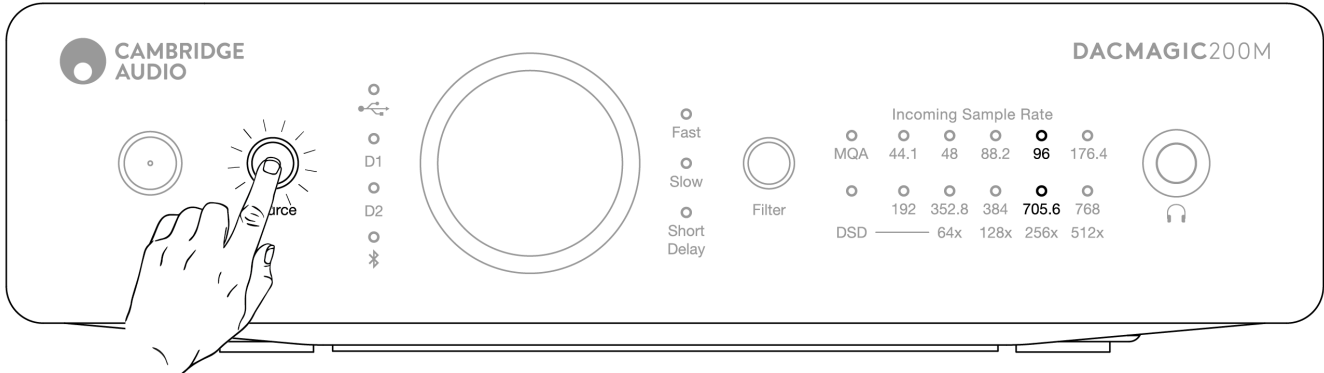

## Frequently asked questions

Last updated: February 9, 2023 09:52. Revision #8871

### Will the DacMagic 200M playback 32-bit files?

Whilst the DacMagic 200M hardware is capable of handling 32-bit audio, the USB interface is reporting the host to be only 24-bit capable.

If you attempt to play 32-bit files the USB driver will convert them to 24-bit by removing the least significant info.

### How can I connect the DacMagic 200M to CXN/851N to allow the playback of MQA files?

If you own a network player such as the CXN/851N, then you may be aware that they do not contain the correct hardware to properly decode MQA files for accurate playback. However, it is possible to perform 'MQA passthrough' with these units, using them alongside the DacMagic 200M which then can 'unfold' the files completely.

You can connect the digital output of your device to one of the digital inputs on the DacMagic 200M either via TOSLINK, or S/P DIF. Please note that CXN and 851N don't support USB audio host functionality, so USB connection cannot be used in conjunction with DM200M.

MQA files will then be passed onto the Dacmagic 200M where full unfolding, and processing can take place, completely bypassing the internal DAC of the connected unit.

The MQA indicator LED on the front panel of the DacMagic 200M will indicate when, and how an MQA file is being processed.

#### Green:

Signifies the output as an MQA File. This indicates that a full decode is being performed by the 200M.

#### Blue:

Signifies MQA Studio. Approved in the studio by the artist/producer or verified by the copyright holder as accurate to the original recording. This indicates that a full decode is being performed by the 200M.

#### Magenta:

The MQA stream is pre-decoded and the unit is operating as a renderer; this means that the unit is outputting a stream that has been decoded by the TIDAL app. Although this is perfectly fine, a better solution is to enable the 200M to execute a full decode.

To do this, turn on MQA passthrough in your TIDAL settings to allow the DacMagic 200M to complete the unfolding process rather than the source device (e.g.: the computer).

### How do I install the latest USB audio driver for the DacMagic 200M?

To install the latest USB Audio driver for your DacMagic 200M, please follow the following steps:

1. Download the correct driver for your Windows operating system from <https://techsupport.cambridgeaudio.com/hc/en-us/articles/207434895-Windows-Audio-USB-Class-2-Driver->
2. Unzip the downloaded folder, and double click on the application file to run the installer.
3. Run the installer and follow the on-screen instructions.
4. Allow the installation to progress, click next, and then finish to complete the installation.
5. Confirm the installation by opening the CA Control Panel with the DacMagic 200M connected and checking the driver version.

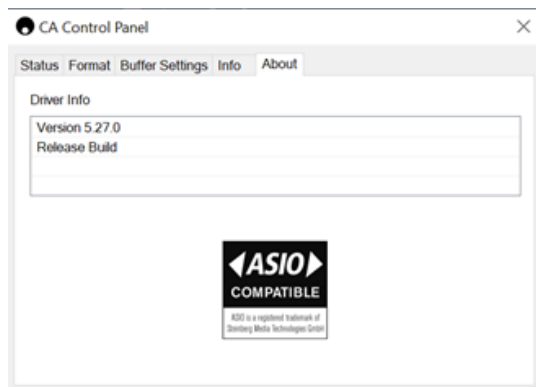

## Technical specifications

Last updated: July 27, 2023 04:20. Revision #10144

### DIGITAL TO ANALOGUE CONVERTERS

Dual ESS ES9028Q2M DACs

### DIGITAL FILTER

Selectable, Fast - Slow - Short delay

### FREQUENCY RESPONSE

10Hz to 50KHz ( $\pm 1$ dB)

### THD+N @ 1KHZ 0DBFS

<0.0005% (A-Weighted)

### SIGNAL TO NOISE RATIO

>115dB (A-Weighted)

### CROSSTALK @ 10KHZ

< -110dB

### OUTPUT IMPEDANCE

<50 Ohms (unbal), <100 Ohm (bal)

### MAX. OUTPUT LEVEL (UNBALANCED)

2.1V rms (fixed or variable - user selectable)

### MAX. OUTPUT LEVEL (BALANCED)

4.2V rms (fixed or variable - user selectable)

### DIGITAL INPUT WORD WIDTHS SUPPORTED

16bit (Bluetooth)

16-24bit (Optical, Coaxial)

16-24bit (USB)

### DIGITAL INPUT SAMPLING FREQUENCIES SUPPORTED

44.1kHz to 96kHz PCM, DoP64 (Optical)

44.1kHz to 192kHz PCM, DoP64 (Coaxial)

44.1kHz to 768kHz PCM, Native DSD 64x to 512x, DoP 64x to 256x (USB)

### MQA COMPATIBILITY

Full decoding (Core + Renderer)

### BLUETOOTH

v4.2, A2DP profile, SBC and AptX codecs

### HEADPHONE OUTPUT THD+N

< 0.001% at 1kHz 0dBFS @ 100mW into 32 Ohm

### S/N

> 115dB (A-Weighted)

### MAX OUTPUT POWER

>300mW @ 32 Ohm, >65mW @ 150 Ohm

### FREQUENCY RESPONSE

10Hz - 50KHz ( $\pm 1$ dB)

### RECOMMEND HEADPHONE IMPEDANCE

10 Ohm to 600 Ohm

### MAX POWER CONSUMPTION

12W

### COLOUR

Lunar Grey

### DIMENSIONS (HXWXD)

52 x 215 x 191mm; (2.0 x 8.6 x 7.6")

### WEIGHT

1.2Kg/2.6lbs