

**The NetCore product family**

**ENGLISH Version**

**The variants for rack mounting**

00089944 Pronomic NetCore SR-3F RJ-45 Rackbox F/F Dual



00089925 Pronomic NetCore SR-3M RJ-45 Rackbox M/M Dual



00085727 Pronomic NetCore SR-3FM RJ-45 Rackbox F/M Parallel



**The variants for mobile usage**

00085739 Pronomic NetCore SB-3FM RJ-45 Stagebox F/M Parallel

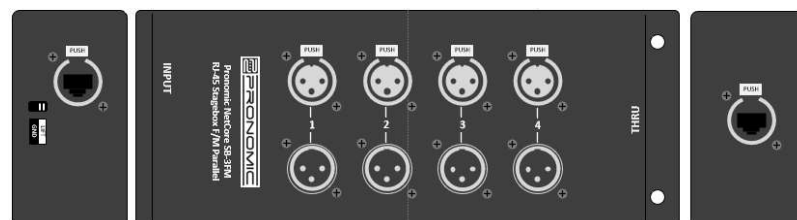

00058780 Pronomic NetCore SB-3F Multicore Stagebox female



00058781 Pronomic NetCore SB-3M Multicore Stagebox male



00058778 Pronomic NetCore SP-3F Multicore Split Female

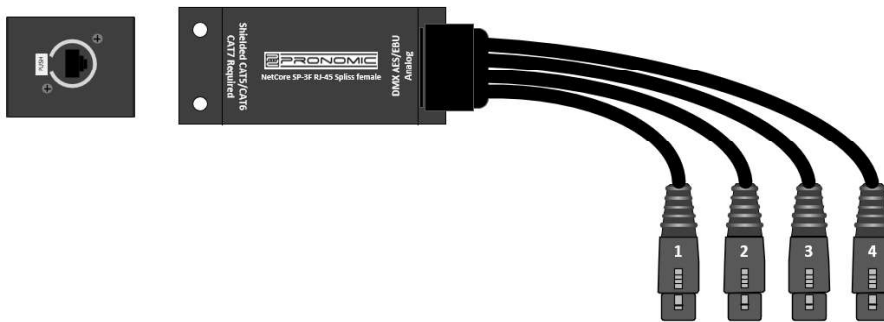

00058779 Pronomic NetCore SP-3M Multicore Split Male

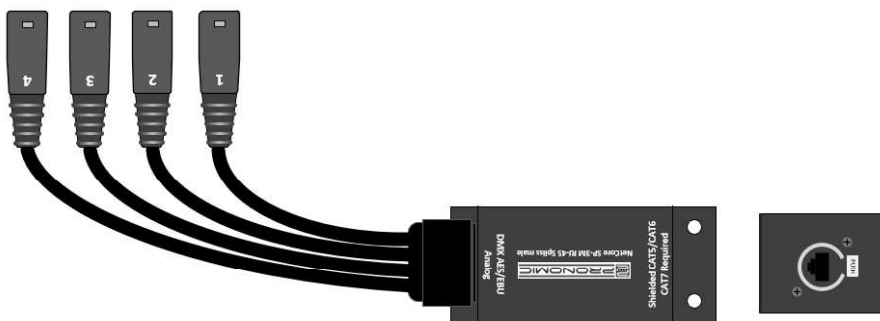

# Operating instructions

ENGLISH Version 11/2022

© 2022

Thank you for choosing this product.

To ensure that you are completely satisfied with this product, please read these operating instructions carefully before using our product. Keep these operating instructions in a safe place. The operating instructions must be passed on to all subsequent users.



Follow the operating instructions!



**WARNING**

The signal word **WARNING** indicates hazards that can lead to serious injuries if no precautionary measures are taken.

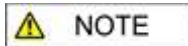

**NOTE**

The signal word **NOTE** indicates general precautions to be observed when handling the product.

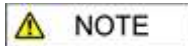

**NOTE**

Images and screen representations in these operating instructions may differ slightly from the appearance of the actual product, as long as this does not have a negative impact on the technical characteristics and safety of the product.

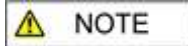

**NOTE**

All person-related formulations in these operating instructions are to be regarded as gender-neutral.

These operating instructions apply to persons who have been supervised or instructed in the operation of the appliance by a person responsible for their safety and who have demonstrated their ability to handle the appliance.



**WARNING**

**Children should be supervised to ensure that they do not play with the appliance. Do not leave children unattended.**

All information in these operating instructions has been checked to the best of our knowledge and belief. However, neither the author nor the publisher can be held liable for any damage in connection with the use of these operating instructions.

Other product, brand and company names mentioned in this document may be the trademarks of their respective owners. Compliance with all applicable copyright laws is the responsibility of the user of this document.

---

## **Safety precautions and precautionary measures**



Always place the appliance securely on a level surface to avoid injury from the appliance falling over.



Do not place any devices that can heat up (e.g. lighting equipment or fog machines) on the unit.

Do not clean the unit with aggressive chemical-based cleaning agents or other solvents.

Keep the unit away from rain and moisture.

Damage caused by non-compliance with this user manual is not covered by the warranty. The dealer accepts no liability for any resulting defects or problems.

Do not bend or twist the cable and do not place any objects on it.

Make sure that no objects or liquids of any kind get into the unit.

Protect the unit from hard impacts.

Make sure that there is never any tension on the cables, this could cause short circuits, cable breaks or an overall defect of the unit.

### **Important information:**

- Before connecting the unit to other devices, you must disconnect all devices from the mains. This prevents malfunctions and/or damage to speakers or other devices.
- For safety reasons and for the unit to function properly, you must ensure that the connection is well earthed.
- Do not expose the unit to direct sunlight, place it near products that give off heat or otherwise expose it to extreme temperatures. Excessive heat may deform and discolour the unit.
- If you move the unit from one room to another where the temperature and/or humidity is very different, water droplets (condensation) may form inside the unit. If you try to use the unit in this condition, damage or malfunction may occur. Therefore, you must inspect the unit before  
Do not use for several hours until the condensation has completely evaporated.
- For daily cleaning, wipe the unit with a soft, dry cloth or a cloth slightly moistened with water. To remove dirt, use a cloth soaked in a mild, non-abrasive detergent. Then wipe the unit thoroughly with a soft, dry cloth.
- Please be careful when using the operating elements of the unit as well as the sockets and connections. Rough handling can lead to defects.
- When connecting/disconnecting all cables, grasp the plug itself, do not pull on the cable. This way you avoid short circuits or damage to the cable.
- If you need to transport the unit, pack it to protect it from damage.

---

## **Product information:**

NetCore is a versatile multicore system that can distribute up to four separate signals. Distribution is via a CAT line to transmit audio, intercom or DMX signals. The type of signal is irrelevant. It is important to note that it is always a direct 1:1 connection via a Cat line (there must be no active devices such as a network switch or similar devices in the signal chain).

As a universal cabling system with simple handling, the different models of the NetCore series can help you with a variety of problems. Whether you use them in a permanent installation or for a mobile solution at concerts or trade fairs - the NetCore series is tailored to your individual needs!

Another advantage is the lightweight, yet very robust construction of the NetCore products, which, thanks to their practical mounting options, ensure safe use, even in difficult places with complicated and branched signal and DMX applications.

All NetCore products are compatible with each other and can be interconnected according to their needs.

The respective XLR signals are routed via the four wire pairs in a network cable. The signals are transmitted separately but under common shielding. The signal transmission is completely latency-free.

The use of conventional network cables via RJ45 or Ethercon not only makes the NetCores an inexpensive consideration, but also makes it possible to reach places that could not be reached before. They also work in existing network connections in buildings, enabling signal transmission in previously unthinkable cable paths, for example across several corridors, floors or fire compartments.

NetCore works with all CAT standards from CAT5 to CAT7 as long as shielding is included. Due to the low cable thickness, the cables can be laid without soldering, for example under carpets, doors and in wall joints.

## **CONNECTIONS**

### **Signal connections:**

The signal connections are all 3-pin XLR connectors. Depending on the model, they are XLR-female, XLR-male or, in the case of the parallel boxes, a combination of both. Here you feed in the signal (XLR-female) or pass it on (XLR-male).

### **INPUT:**

At the INPUT (RJ-45) plug in the network cable coming from your feed point

### **THRU:**

The THRU socket (RJ-45) carries the signal in parallel to the INPUT socket. This allows you to forward the INPUT signals to other NetCore boxes. If there is no signal at the INPUT socket, use the THRU socket as an output socket.

---

## **Ground/Lift switch:**

You can prevent ground loops with the ground lift switch. If you operate the rack box together with other units in a 19" rack, the switch should be in the "Ground" position. If you notice hum in the audio system, move the switch to "Lift". This may solve the problem of different earthing potentials and may eliminate the hum.

## **Areas of application:**

Whether analogue signals or digital signals such as MIDI or AES/EBU, NetCore can be used equally for these signals; the maximum cable length depends on the sampling rate and the quality of the cable used. Phantom powering is possible when using shielded cables. It is important to avoid combining different signals within one system, as plugging errors could occur. Technically, however, it would be possible.

Because there is no defined signal direction, no directional misrouting is possible.

You can also connect the NetCore products in series to create genderchangers and passive splits or Y-adapters.

With the many possible applications, however, it is indispensable to think about the signal flow. Because the signal connections are parallel in both directions, the connected devices can be damaged if the signal direction is confused.

### **As stage box and rack box for consoles, loudspeakers and wireless radio receivers**

- Connecting multi-channel applications such as delay lines, monitor amp-racks
- Connecting power amplifiers for stage technology such as linear arrays or similar sound systems
- Connection of in-ear monitors and wireless microphone receivers in groups
- Connecting mixers and submixers for music
- Everything that needs to be wired in a structured way

### **As a fixed installation in buildings with the necessary infrastructure**

- Connection of studios to rehearsal rooms
- Use for interpreting equipment, cloakrooms, back offices, multi-offices
- Churches, town halls, cultural centres where many connection points can be connected with few stage boxes

### **Typical applications for the 4-channel NetCore**

- Return core for e.g. sum L/R, subwoofer and monitor
- Subcore to the stagebox, e.g. for percussion, keyboards or background vocals
- DJ stations with monitoring signal and stereo sum
- Conference/multi-room technology for panel discussions and lecterns, but also podcasting

**GERMAN / ENGLISH Anwendungsbeispiele/ Usage examples**

**Stagesetup Example 1**

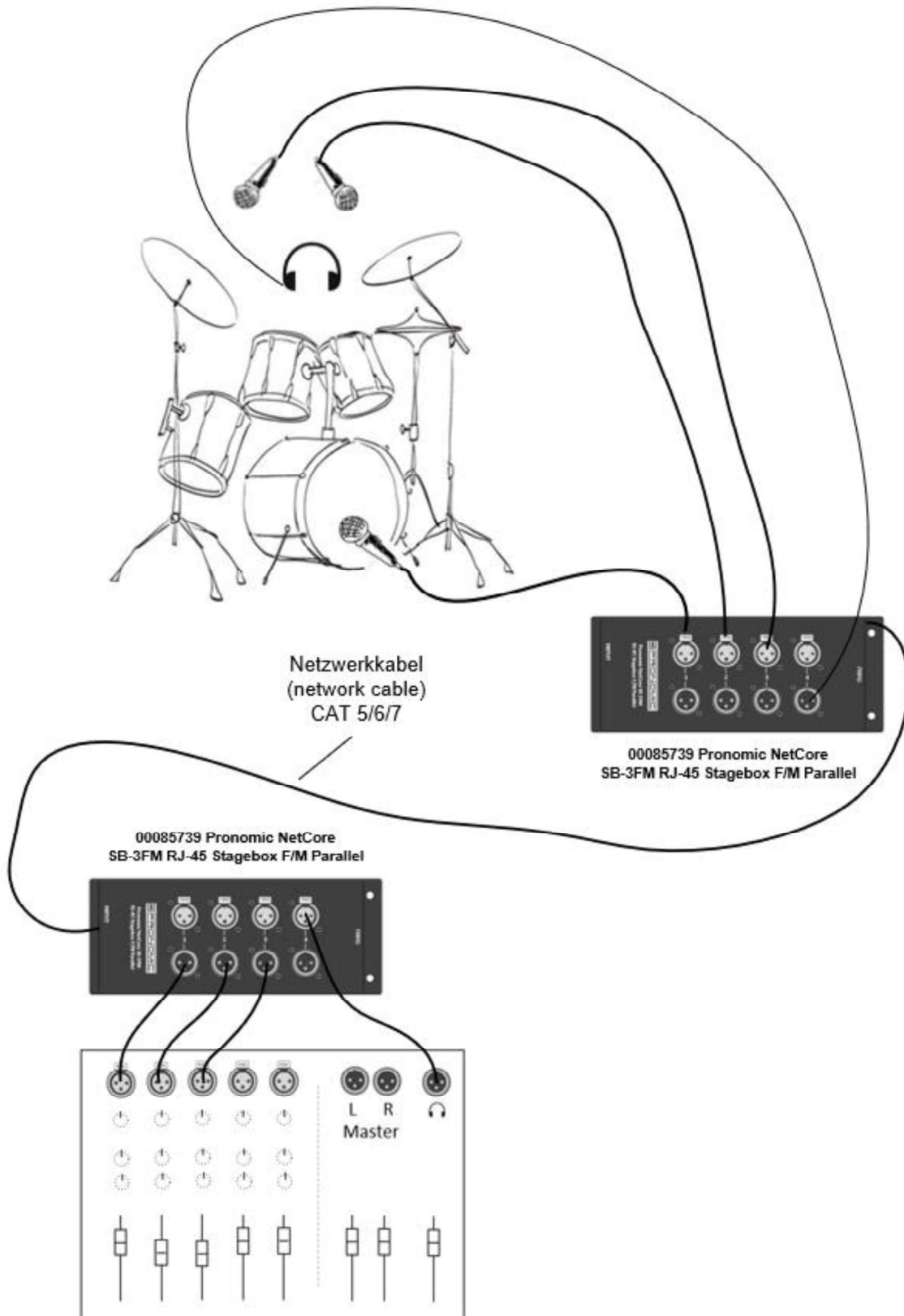

## Stagesetup Example 2

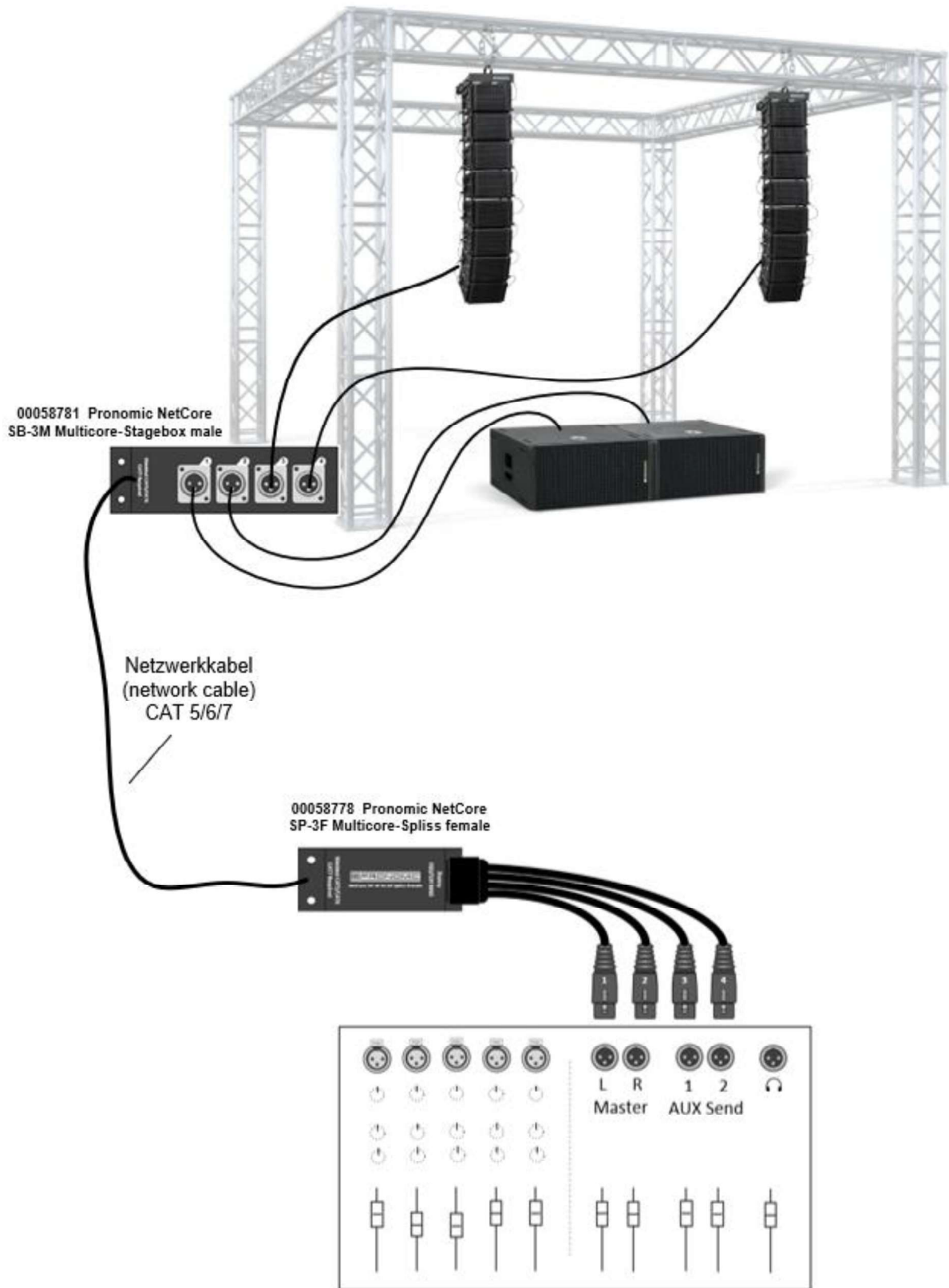

## Stagesetup Example 3

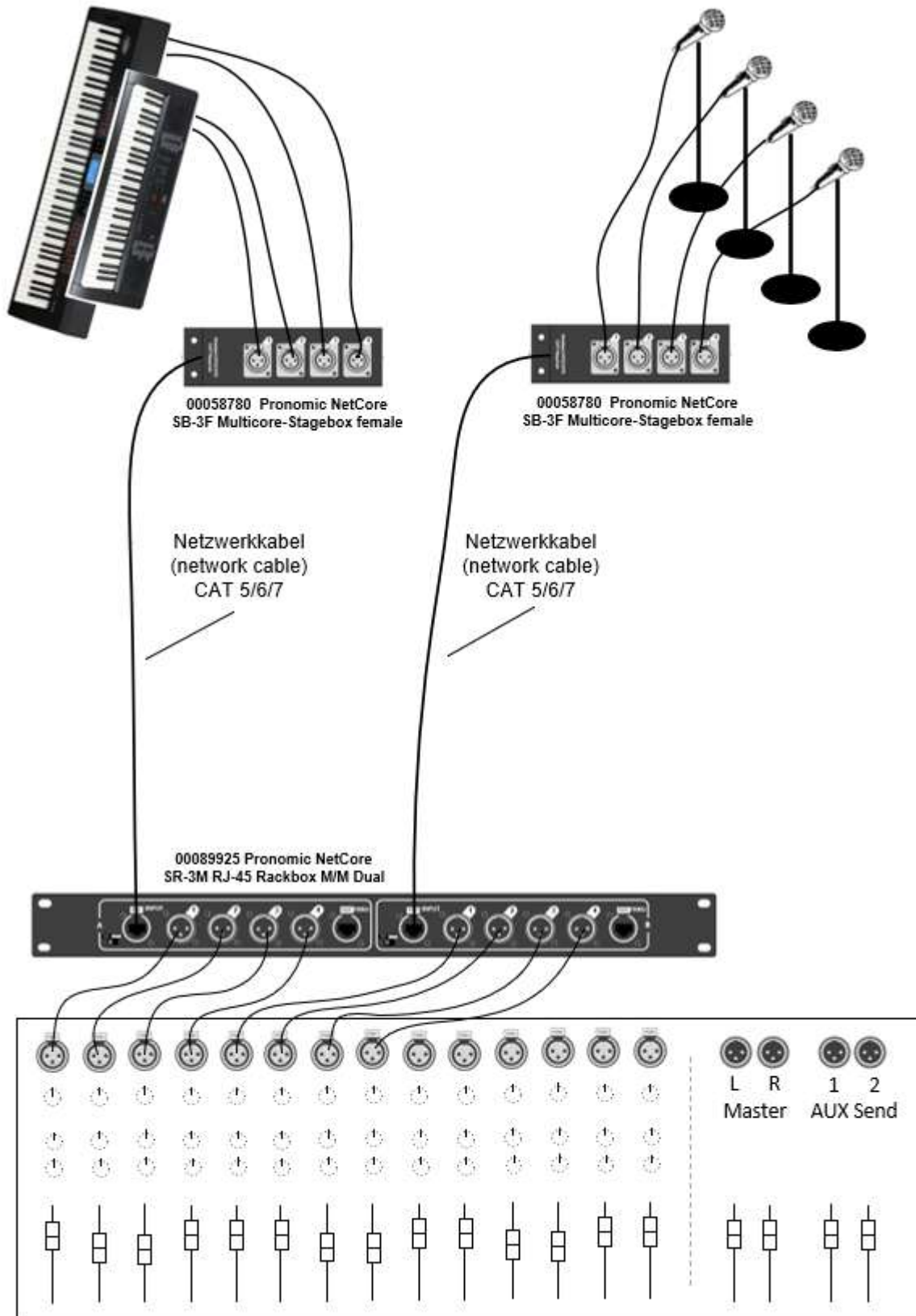

## Schaltpläne/Circuit diagrams:

### 00089944 Pronomic NetCore SR-3F RJ-45 Rackbox F/F Dual

Channel A and B are identical

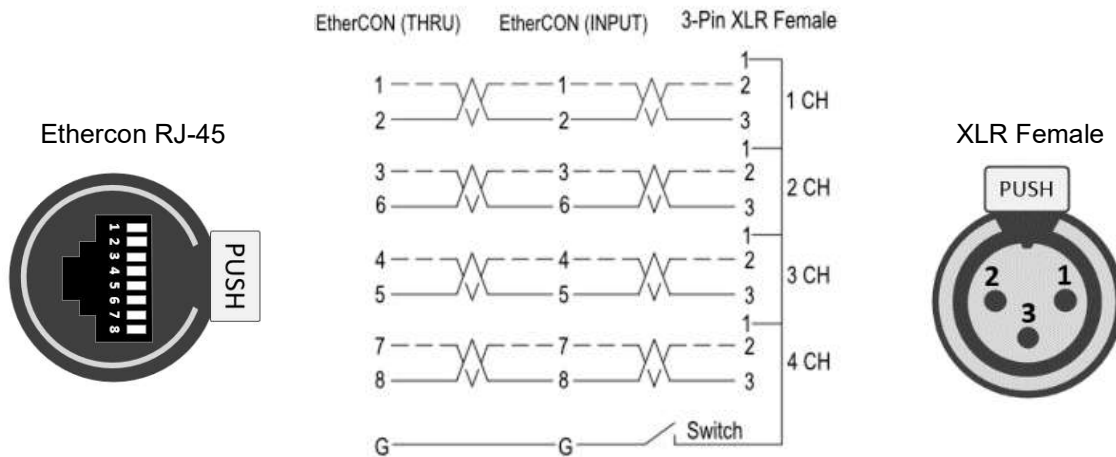

### 00089925 Pronomic NetCore SR-3M RJ-45 Rackbox M/M Dual

Channel A and B are identical

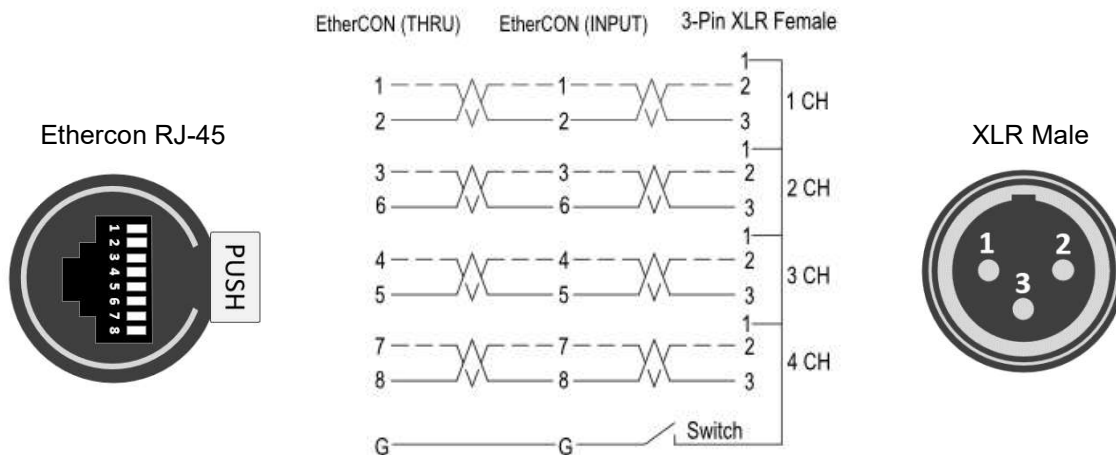

00085727 Pronomic NetCore SR-3FM RJ-45 Rackbox F/M Parallel

00085739 Pronomic NetCore SB-3FM RJ-45 Stagebox F/M Parallel

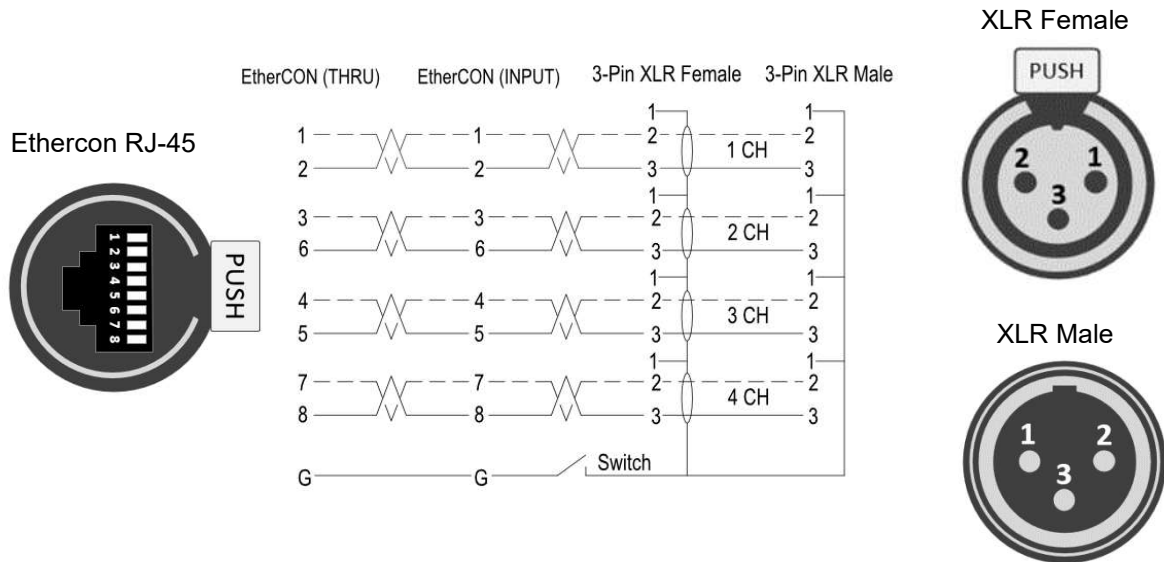

## WEEE Declaration

### (Waste of Electrical and Electronic Equipment)

Your product has been designed and manufactured using high quality materials and components that are recyclable and reusable. The symbol means that your product must be disposed of separately from household waste at the end of its life. Dispose of this appliance at your local collection point or recycling centre.

Please help protect the environment in which we all live.

All technical data and appearances are subject to change without notice. All information was correct at the time of going to press. Musikhaus KIRSTEIN GmbH does not guarantee the accuracy or completeness of the descriptions, photographs or statements contained in this manual. Printed colours and specifications may differ slightly from the product. Musikhaus KIRSTEIN GmbH products are only sold through authorised distributors. Distributors and dealers are not representatives of Musikhaus KIRSTEIN GmbH and are not authorised to legally bind Musikhaus KIRSTEIN GmbH in any way.



**Musikhaus KIRSTEIN GmbH**  
**Bernbeurener Straße 11**  
**86956 Schongau - Germany**  
**Phone: 0049-8861/909494-0**  
**Fax: 0049-8861/909494-19**

