

FLEXstand FX ILS

User Manual

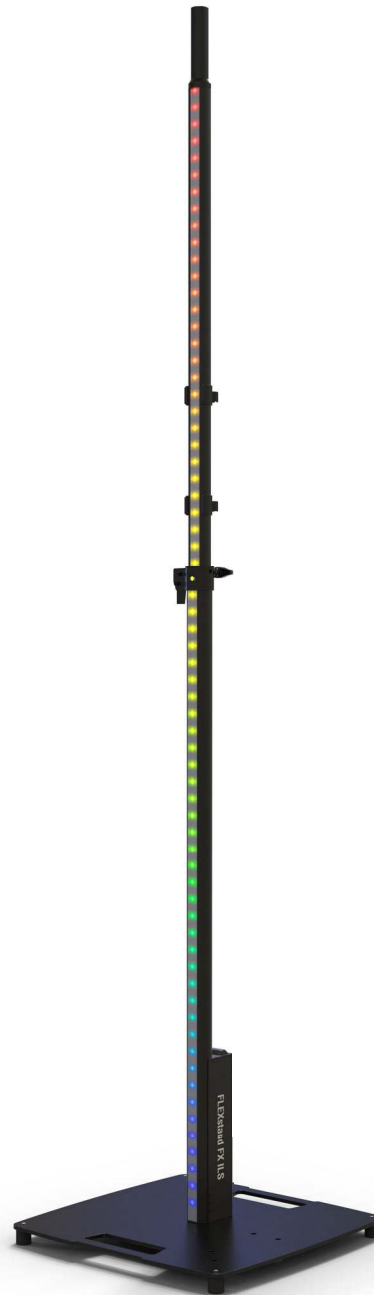

Edition Notes

The FLEXstand FX ILS User Manual includes a description, safety precautions, installation, programming, operation, and maintenance instructions for the FLEXstand FX ILS as of the release date of this edition.

Trademarks

Chauvet, Chauvet DJ, the Chauvet logo, and FLEXstand ILS are registered trademarks or trademarks of Chauvet & Sons, LLC (d/b/a Chauvet and Chauvet Lighting) in the United States and other countries. Other company and product names and logos referred to herein may be trademarks of their respective companies.

Copyright Notice

The works of authorship contained in this manual, including, but not limited to, all designs, text, and images are owned by Chauvet.

© **Copyright 2025 Chauvet & Sons, LLC. All rights reserved.**

Electronically published by Chauvet in the United States of America.

Manual Use

Chauvet authorizes its customers to download and print this manual for professional information purposes only. Chauvet expressly prohibits the usage, copy, storage, distribution, modification, or printing of this manual or its content for any other purpose without written consent from Chauvet.

Document Printing

For best results, print this document in color, on letter size paper (8.5 x 11 in), double-sided. If using A4 paper (210 x 297 mm), configure the printer to scale the content accordingly.

Intended Audience

Any person installing, operating, and/or maintaining this product should completely read through the guide that shipped with the product, as well as this manual, before installing, operating, or maintaining this product.

Disclaimer

Chauvet believes that the information contained in this manual is accurate in all respects. However, Chauvet assumes no responsibility and specifically disclaims any and all liability to any party for any loss, damage, or disruption caused by any errors or omissions in this document, whether such errors or omissions result from negligence, accident, or any other cause. Chauvet reserves the right to revise the content of this document without any obligation to notify any person or company of such revision; however, Chauvet has no obligation to make, and does not commit to make, any such revisions.

Document Revision

Go to www.chauvetdj.com for the latest version.

Revision	Date	Description
5	11/2025	Amended safety notes

TABLE OF CONTENTS

1. Before You Begin	1
What Is Included	1
Unpacking Instructions	1
Claims	1
Text Conventions	1
Symbols	1
Safety Notes.....	2
RF Exposure Warning for North America and Australia.....	2
2. Introduction.....	3
Product Overview.....	3
Product Dimensions	4
3. Setup.....	5
AC Power.....	5
Fuse Replacement	5
Power Linking.....	6
Mounting	7
Height Adjustment.....	8
Rigging	8
4. Operation.....	9
Control Panel Operation.....	9
Menu Map	9
Auto Program Chart	11
DMX Configuration.....	11
Personality and Starting Address	11
D-Fi USB Connectivity	12
D-Fi USB Compatibility	12
D-Fi USB Configuration.....	12
DMX Channel Assignments and Values	13
Zones for DMX Control	13
15 Ch / 4 Ch	14
94 Ch / 66 Ch / 34 Ch / 18 Ch	16
Standalone Configuration.....	18
Static Color Mode.....	18
Automatic Program	18
Auto Program Speed.....	18
Sound-Active Mode	18
Sound Sensitivity.....	18
Custom Color Mixing	19
Dimmer.....	19
Factory Reset.....	19
Wired Master/Slave Mode.....	19
D-Fi USB Master/Slave Mode	20
ILS Mode.....	20
RFC Remote Control.....	20
RFC Remote Binding	20
RFC Control Options.....	21
RFC Remote Control Operation.....	21
5. Maintenance.....	23
Product Maintenance	23
6. Technical Specifications.....	24
Contact Us.....	25
Warranty & Returns.....	25

1. Before You Begin

What Is Included

- FLEXstand FX ILS
- Power cable
- Base
- Extension pole
- Carry bag
- Cable clips (x 2)
- Quick Reference Guide

Unpacking Instructions

Carefully unpack the product immediately and check the container to make sure all the parts are in the package and are in good condition.

Claims





If the box or the contents (the product and included accessories) appear damaged from shipping, or show signs of mishandling, notify the carrier immediately, not Chauvet. Failure to report damage to the carrier immediately may invalidate a claim. In addition, keep the box and contents for inspection.

For other issues, such as missing components or parts, damage not related to shipping, or concealed damage, file a claim with Chauvet within 7 days of delivery.

Text Conventions

Convention	Meaning
1–512	A range of values
50/60	A set of values of which only one can be chosen
Settings	A menu option not to be modified
<ENTER>	A key to be pressed on the product’s control panel
ON	A value to be entered or selected

Symbols

Symbol	Meaning
	Electrical warning. Not following these instructions may cause electrical damage to the product, accessories, or the user.
	Critical installation, configuration, or operation information. Not following these instructions may make the product not work, cause damage to the product, or cause harm to the operator.
	Important installation or configuration information. The product may not function correctly if this information is not used.
	Useful information.

Safety Notes

These Safety Notes include important information about installation, use, and maintenance of the FLEXstand FX ILS.



- **ALWAYS:**
 - ◆ Connect to a grounded circuit.
 - ◆ Connect to operating voltages as specified on the product's spec sticker.
 - ◆ Disconnect from power before replacing the fuse.
 - ◆ Disconnect from its power source during periods of inactivity.
 - ◆ Use a safety cable when suspending overhead.
 - ◆ Heed all restrictions and warnings on the spec sticker.
 - ◆ Mount in a location with at least 20 in (50 cm) of ventilation.
 - ◆ Replace the fuse with the same type and rating.
- In the event of a serious operating problem, stop using immediately.
- **DO NOT:**
 - ◆ Open this product or attempt any repairs. It contains no user-serviceable parts.
 - ◆ Look at the light source when the product is on.
 - ◆ Use if the power cable is crimped or damaged.
 - ◆ Disconnect by pulling on the power cable.
 - ◆ Allow flammable materials close to the product when it is operating.
 - ◆ Touch the housing when it is on.
 - ◆ Block any ventilation holes/slots in the housing.
 - ◆ Connect to a dimmer or rheostat.
 - ◆ Carry the product by its power cable.
 - ◆ Operate in temperatures higher than 104°F (40°C).
 - ◆ Expose to environments that exceed the Ingress Protection (IP) rating.
 - ◆ Expose to rain or moisture.
 - ◆ Use outdoors.
 - ◆ Submerge.
 - ◆ Suspend this product overhead.



Keep this User Manual for future use. If the product is sold to someone else, be sure that they also receive this document.

RF Exposure Warning for North America and Australia

Warning! This equipment complies with FCC radiation exposure limits set forth for an uncontrolled environment. This equipment should be installed and operated with a minimum distance of 20 cm between the radiator and the user. This transmitter must not be co-located or operating in conjunction with any other antenna or transmitter.

2. Introduction

Product Overview

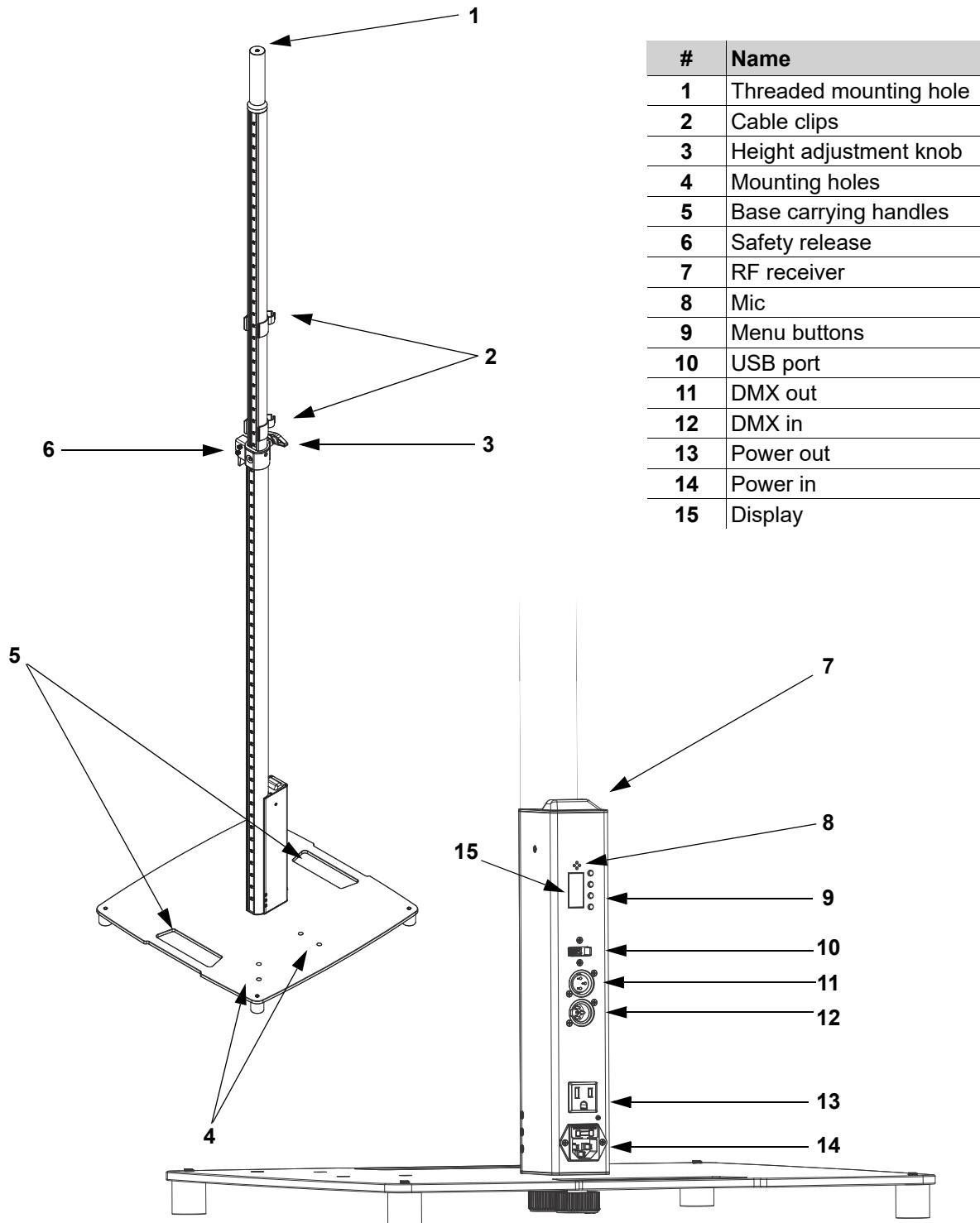

WARNING! DO NOT plug anything other than a D-Fi USB into the USB type B port. Doing so may cause damage to the product.

Product Dimensions

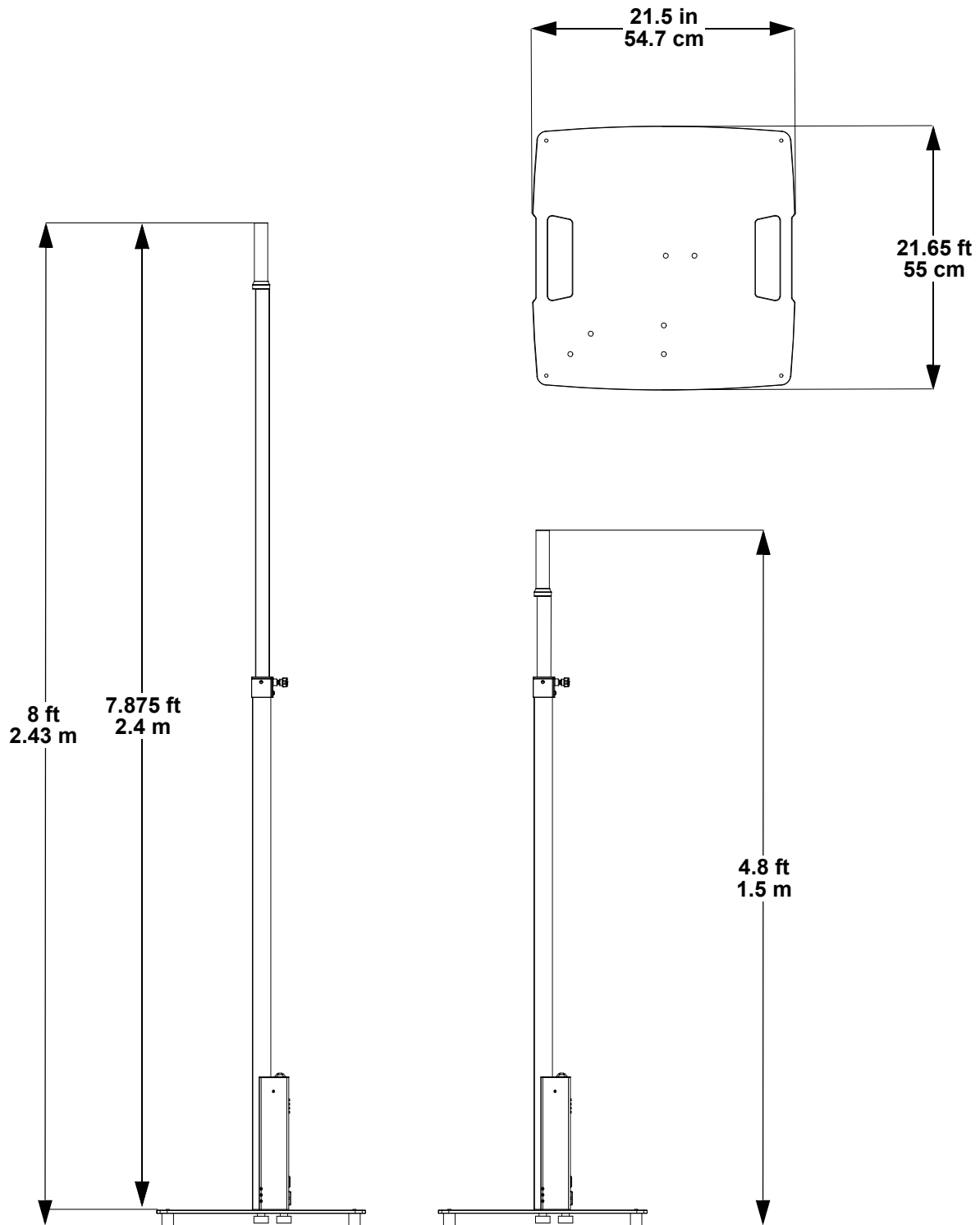

3. Setup

AC Power

The FLEXstand FX ILS has an auto-ranging power supply and it can work with an input voltage range of 100 to 240 VAC, 50/60 Hz.

To determine the product's power requirements (circuit breaker, power outlet, and wiring), use the current value listed on the label affixed to the product's back panel, or refer to the product's specifications chart. The listed current rating indicates the product's average current draw under normal conditions.



- **Always connect the product to a protected circuit (a circuit breaker or fuse). Make sure the product has an appropriate electrical ground to avoid the risk of electrocution or fire.**
- **To eliminate unnecessary wear and improve its lifespan, during periods of non-use completely disconnect the product from power via breaker or by unplugging it.**



Never connect the product to a rheostat (variable resistor) or dimmer circuit, even if the rheostat or dimmer channel serves only as a 0 to 100% switch.

Fuse Replacement

1. Disconnect the product from power.
2. Wedge the tip of a flat-head screwdriver into the slot of the fuse holder.
3. Pry the fuse holder out of the housing.
4. Remove the blown fuse from the holder and replace with a fuse of the exact same type and rating.
5. Insert the fuse holder back in place and reconnect power.

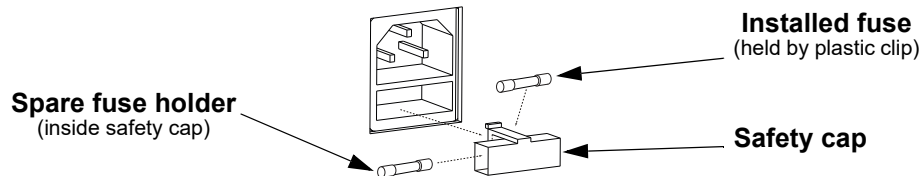

Disconnect the product from the power outlet before replacing the fuse.



Always replace a blown fuse with one of the same type and rating.

Power Linking

This product provides power linking via the outlet located in the back of the product. See the diagram below for further explanation.

Power Linking Diagram

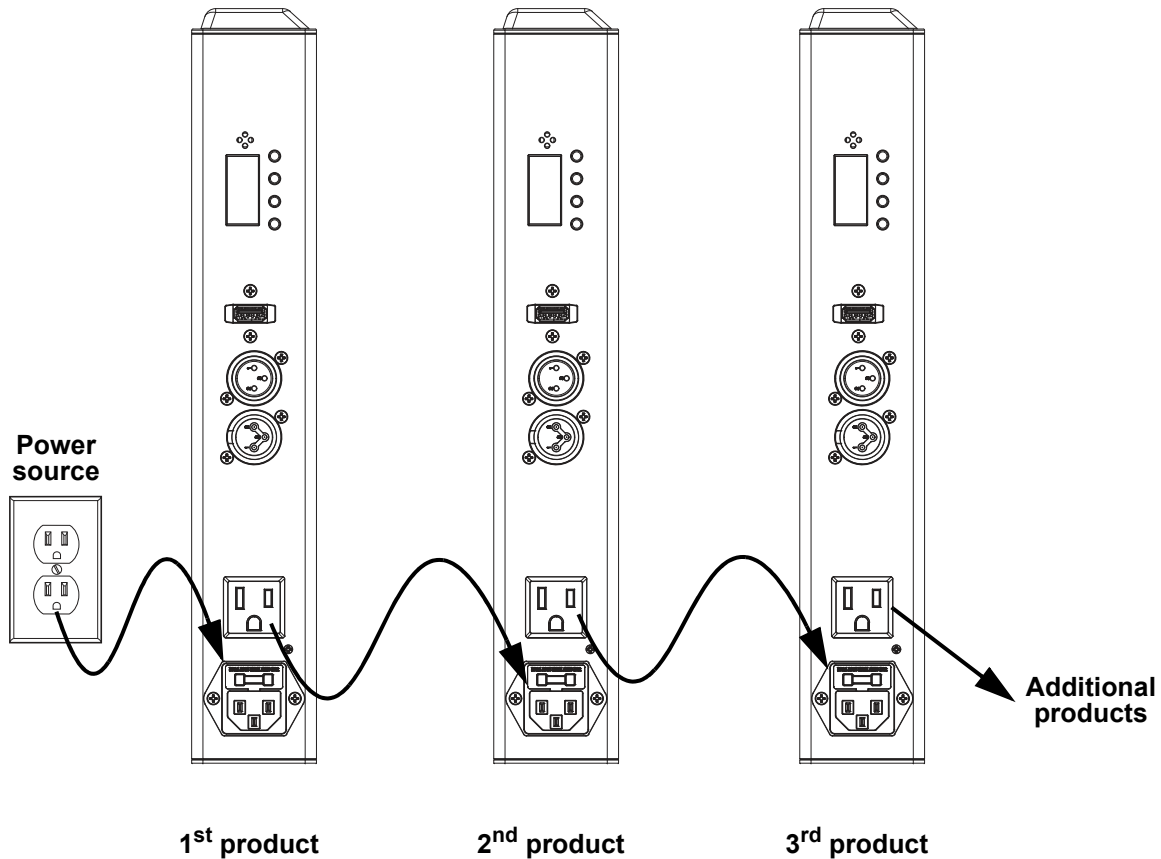

It is possible to link up to 34 FLEXstand FX ILS products on 120 VAC or up to 47 products on 230 VAC.



The power linking diagram shown above corresponds to the North American version of the product **ONLY!** If using the product in other markets, consult with the local Chauvet distributor as power linking connectors and requirements may differ by country or region.

Mounting

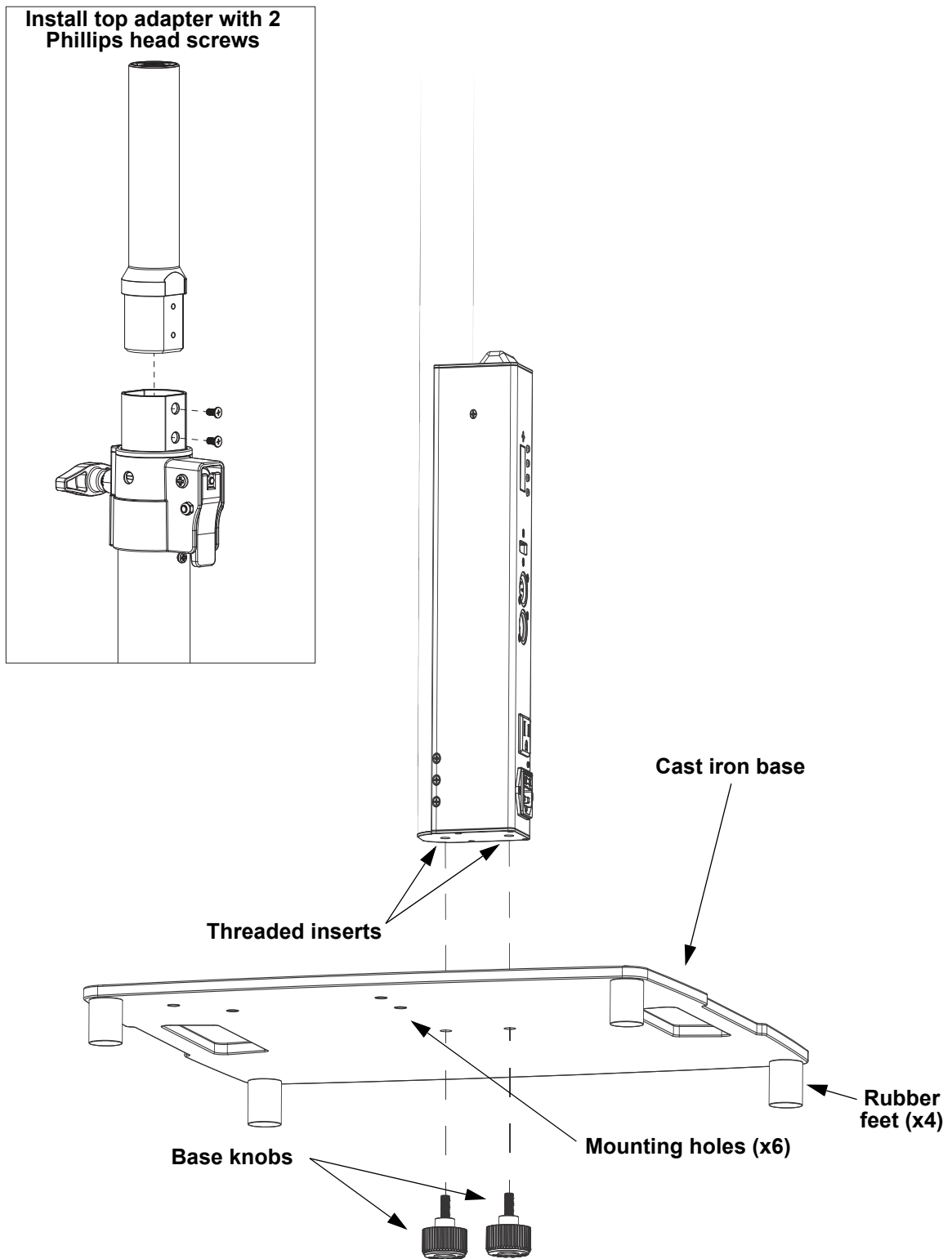

Height Adjustment

To adjust the height of the extension pole:

1. Loosen the height adjustment knob. If lowering the stand, press and hold the safety release.
2. Adjust to desired height and let go of safety release.
3. Adjust until safety release clicks into notch along pole length.
4. Tighten the height adjustment knob.

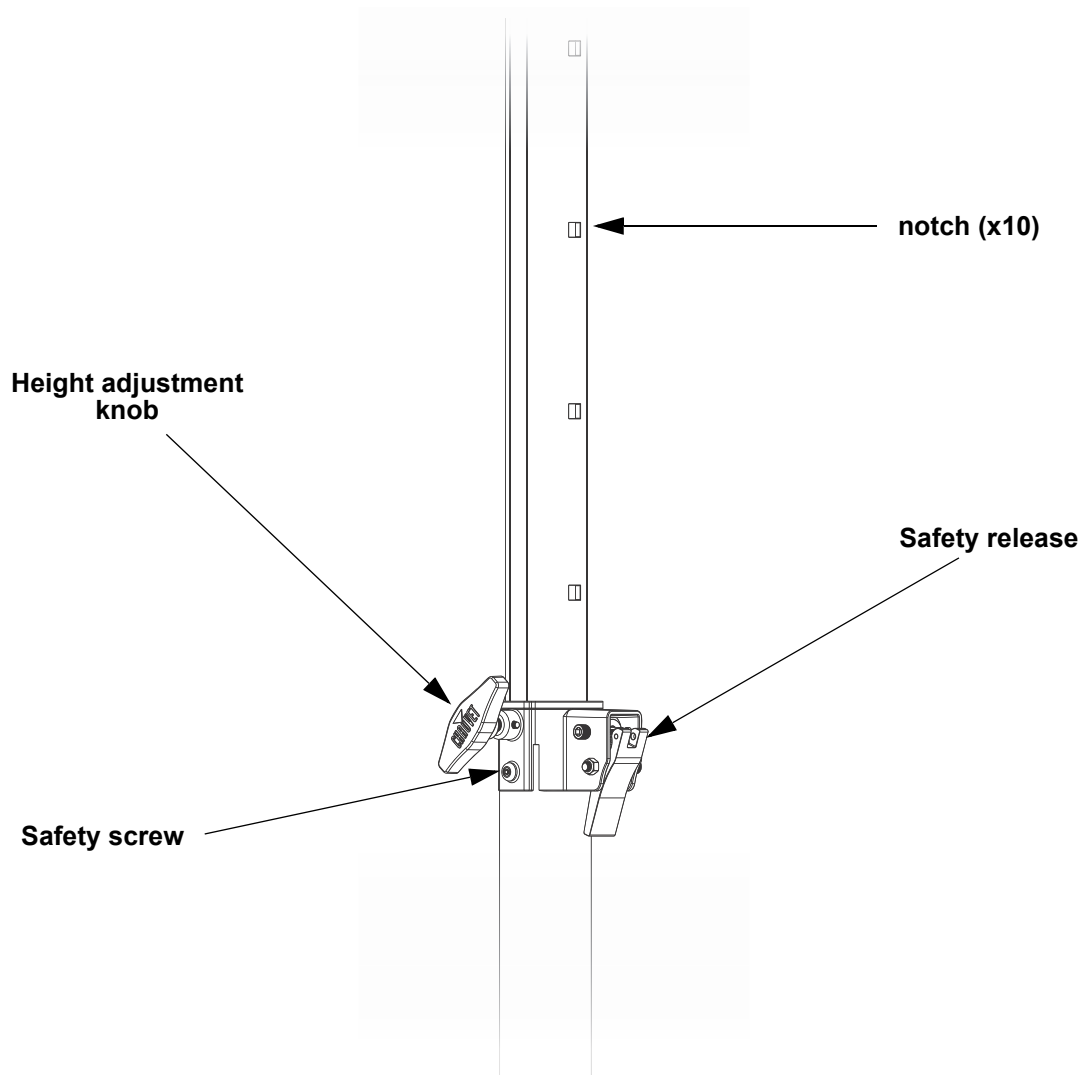

 The telescoping portion of the FLEXstand FX ILS can be locked into place by tightening the safety screw beneath the height adjustment knob. An allen key is provided inside the packaging for this purpose.

Rigging

- Before deciding on a location for the product, always make sure there is easy access to the product for maintenance and programming.
- Make sure that the structure can support the weight of an object before mounting it atop the product (see the [Technical Specifications](#) section for weight information).
- When power linking multiple products, position the products close enough for power linking cables to reach.

When positioning the product, make sure that the product and cables are away from people and vehicles.

4. Operation

Control Panel Operation

To access the control panel functions, use the four buttons located underneath the display. Please refer to the [Introduction](#) to see the button locations on the control panel.

Button	Function
<MENU>	Press to find an operation mode or to back out of the current menu option
<UP>	Press to scroll up the list of options or to find a higher value
<DOWN>	Press to scroll down the list of options or to find a lower value
<ENTER>	Press to activate a menu option or a selected value

Menu Map

Refer to the FLEXstand FX ILS product page on www.chauvetdj.com for the latest menu map and software.

Mode	Programming Levels		Description		
ILS Mode	iLS	iLS1–2	Sets ILS mode		
DMX Mode	4Ch	A001–509	4-channel DMX mode		
	15Ch		15-channel DMX mode		
	18Ch		18-channel DMX mode		
	34Ch		34-channel DMX mode		
	66Ch		66-channel DMX mode		
	94Ch		94-channel DMX mode		
Static Colors	C--	C1	Red		
		C2	Green		
		C3	Blue		
		C4	Wm White		
		C5	Lime		
		C6	Magenta		
		C7	Cyan		
		C8	Hot Pink		
		C9	Amber		
		C10	Lt Blue		
		C11	Pink		
		C12	Kelly Gr		
		C13	Violet		
		C14	Wm White 2		
		C15	Yellow		
		C16	Cl White 2		
		C17	Turquoise		
		C18	Lt Pink		
		C19	Orange		
		C20	Cl White		
Auto Programs	P--	P 1–26 (see Auto Program Chart)	Automatic programs		
Auto Speed	S--	P 1–25	Sets program speed (slow to fast)		
Sound Mode	Snd	Snd 1–26 (see Auto Program Chart)	P–St	Sing	Program uses single color
				Loop	Program loops through preset colors
				Rand	Program displays preset colors in random order

Mode	Programming Levels			Description	
Sound Mode (cont.)	Snd	Snd 1–26 (see Auto Program Chart)	r-Co	Co 1–Co 20	Select a color for a single-color program
			LoSt	bLAC	All lights black out when sound is lost
				ShoW	Defaults to auto program when sound is lost
				FrEE	Program freezes when sound is lost
Sensitivity	SEnS	Snd 1–3	Co 1–Co 20	Sets sound sensitivity	
Custom Color Mixing	U--		r000–255	Custom static colors Combine red, green, blue, and white	
			G000–255		
			b000–255		
			U000–255		
Dimmer Mode	diM		oFF	Off	
			diM 1	Dimmer speed settings from fast (1) to slow (3)	
			diM 2		
			diM 3		
RF Setting	SEt	rF	oFF	Turns off RF	
			LinK	Enables control of fixture using only a paired RF remote	
			PubL	Enables control of fixture using any RF remote	
		rF-G	Gro1–4	Sets RF Group (for use with RFC-XL remote only)	
		LEn	L 1–10	Sets active zones to adjust for stand height (Settings correspond to the height-adjustment notches on the stand. L1 is for notch 1, L2 is for notch 2, and so on)	
		rESt	no yES	Reset factory default settings	

Auto Program Chart

Auto	Pattern	Direction	Sound Mode
1	Color chase 1	Alternating	Color change, output increases
2	Color chase/fade 1	Top to bottom	Output increases
3	Color chase/fade 1	Bottom to top	Output increases
4	LED on/off transition 1	–	Background color output increases
5	Color chase 2	Top to bottom	Background color output increases
6	Color chase 2	Bottom to top	Output increases
7	Color fade + LED on/off transition 1	–	Background color output increases
8	Stretch out and draw back	Center toward ends/ Ends toward center	Background color output increases
9	Color chase 3	Alternating	Background color output increases
10	LED on/off transition 2	–	Background color output increases
11	Color chase 4	Alternating	Background color output increases
12	Color chase 5	Center toward ends	Output increases
13	Color chase 5	Ends toward center	Output increases
14	Color chase 6	Alternating	Background color output increases
15	LED on/off transition 3	–	Background color output increases
16	LED on/off transition 4	–	Background color output increases
17	LED on/off transition 5	–	Background color output increases
18	LED on/off transition 6	–	Background color output increases
19	Fade in	–	Background color output increases
20	LED on/off transition 7	–	Background color output increases
21	Color fade	–	Output increases
22	Color fade + white strobe	–	Output increases
23	LED on/off transition 8	–	Background color output increases
24	Color chase 7	Alternating	Background color output increases
25	Color chase 8	Alternating	Background color output increases
26	Cycle through programs 1–25	–	Cycle through programs 1–25

DMX Configuration

The FLEXstand FX ILS works with a DMX controller. Information about DMX is in the Chauvet DMX Primer, which is available from the Chauvet website chauvetlighting.com/downloads/DMX_Primer_rev05_WO.pdf.

Personality and Starting Address

The FLEXstand FX ILS uses up to 509 DMX channels in the 4-Channel DMX mode, which defines the highest configurable/recommended address to 509.

When selecting a starting DMX address, always consider the number of DMX channels the DMX mode uses. If the starting address is set too high, access to some channels could be restricted.

For information about the DMX protocol, download the DMX Primer from www.chauvetdj.com.

To select the personality and starting address, do the following:

1. Press **<MENU>** repeatedly until **4Ch**, **15Ch**, **18Ch**, **34Ch**, **66Ch**, or **94Ch** shows on the display.
2. Press **<ENTER>**.
3. Use **<UP>** or **<DOWN>** to select the starting address, from **001–509**.
4. Press **<ENTER>**.

D-Fi USB Connectivity

The FLEXstand FX ILS is able to become a D-Fi wireless receiver/transmitter with the use of the D-Fi USB from Chauvet DJ. Simply set the product's DMX Personality and DMX Address, set the DIP switch D-Fi receiving/transmitting channel, then plug it into the D-Fi USB port.



WARNING! DO NOT plug anything other than a D-Fi USB into the USB type B port. Doing so may cause damage to the product.



Once plugged in, the D-Fi USB will take over the product. Wired DMX and manual display control / menu buttons will be unavailable until the D-Fi USB is unplugged. The priority levels are:

1. D-Fi USB
2. Wired DMX
3. Manual Digital Display/Menu Buttons

D-Fi USB Compatibility

The D-Fi USB can receive a DMX signal from the D-Fi Hub and the FlareCON Air 2 as well as other D-Fi USB products.

D-Fi USB Configuration

1. Set the DMX Personality and DMX address on the FLEXstand FX ILS.
2. Use the Chart provided to set **BOTH**:
 - the Channel, and then
 - The Receiving or Transmitting option

NOTE: DIP Switch 5 is for Transmitting OR Receiving, please choose carefully.

D-Fi USB DIP Switch Channels

Receiving					Receiving					Transmitting					Transmitting								
Ch.	1	2	3	4	T/R	Ch.	1	2	3	4	T/R	Ch.	1	2	3	4	T/R	Ch.	1	2	3	4	T/R
1	█	█	█	█	█	9	█	█	█	█	█	1	█	█	█	█	█	9	█	█	█	█	█
2	█	█	█	█	█	10	█	█	█	█	█	2	█	█	█	█	█	10	█	█	█	█	█
3	█	█	█	█	█	11	█	█	█	█	█	3	█	█	█	█	█	11	█	█	█	█	█
4	█	█	█	█	█	12	█	█	█	█	█	4	█	█	█	█	█	12	█	█	█	█	█
5	█	█	█	█	█	13	█	█	█	█	█	5	█	█	█	█	█	13	█	█	█	█	█
6	█	█	█	█	█	14	█	█	█	█	█	6	█	█	█	█	█	14	█	█	█	█	█
7	█	█	█	█	█	15	█	█	█	█	█	7	█	█	█	█	█	15	█	█	█	█	█
8	█	█	█	█	█	16	█	█	█	█	█	8	█	█	█	█	█	16	█	█	█	█	█

DMX Channel Assignments and Values Zones for DMX Control

Diagram depicts zones for the 94-channel DMX personality while using the default Length setting (10). Zone sizes and location change based on selected DMX personality and Length setting.

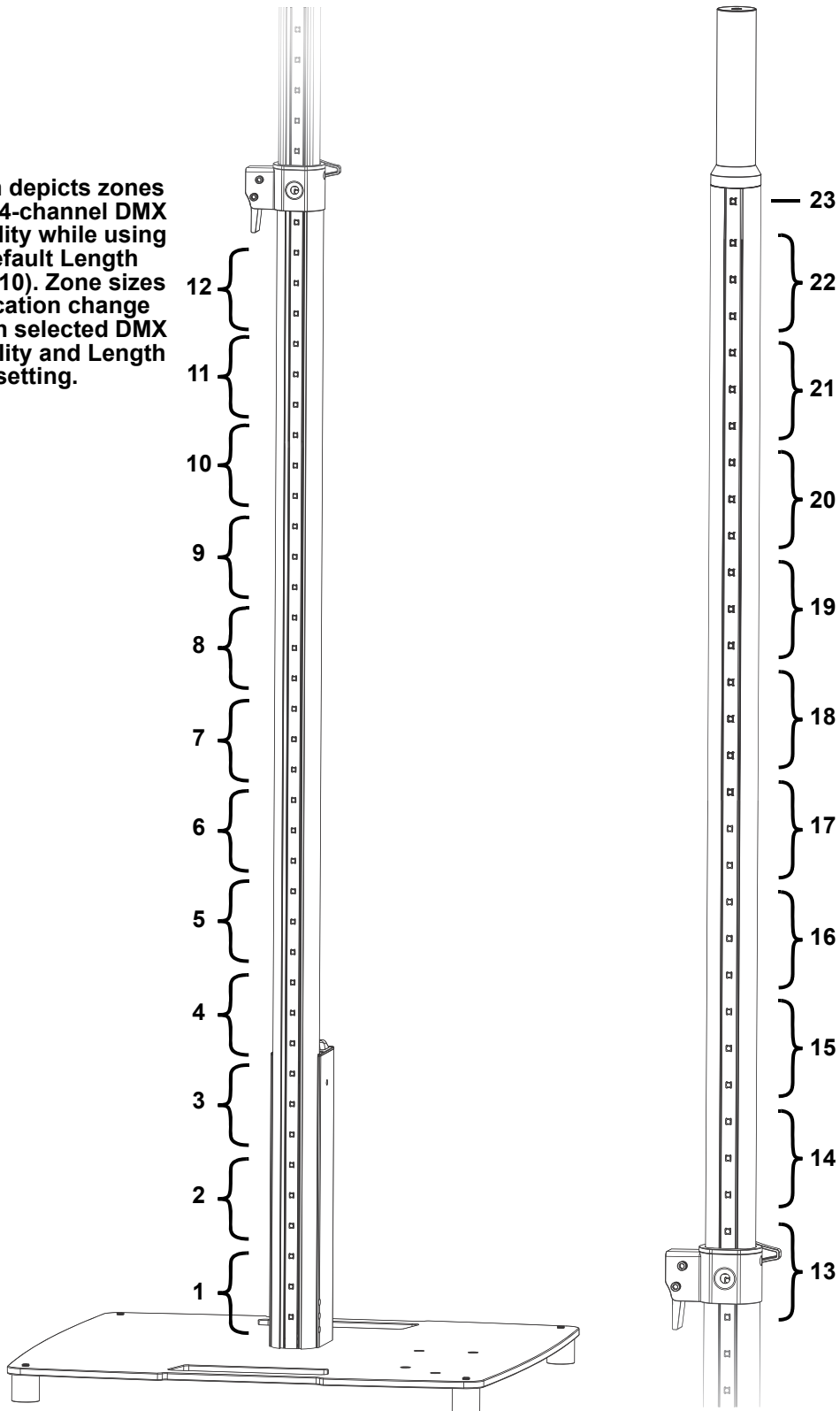

15 Ch / 4 Ch

4Ch	15Ch	Function	Value	Percent/Setting
-	1	Dimmer	000 ⇔ 255	0–100%
1	2	Red	000 ⇔ 255	0–100%
2	3	Green	000 ⇔ 255	0–100%
3	4	Blue	000 ⇔ 255	0–100%
4	5	White	000 ⇔ 255	0–100%
-	6	CTC	000 ⇔ 005	No function
			006 ⇔ 255	Color temperature, 2700K-8000K
-	7	Strobe	000 ⇔ 010	No function
			011 ⇔ 255	Strobe, slow to fast
-	8	Auto Programs	000 ⇔ 010	No function
			011 ⇔ 018	Auto program 1
			019 ⇔ 026	Auto program 2
			027 ⇔ 034	Auto program 3
			035 ⇔ 042	Auto program 4
			043 ⇔ 050	Auto program 5
			051 ⇔ 058	Auto program 6
			059 ⇔ 066	Auto program 7
			067 ⇔ 074	Auto program 8
			075 ⇔ 082	Auto program 9
			083 ⇔ 090	Auto program 10
			091 ⇔ 098	Auto program 11
			099 ⇔ 106	Auto program 12
			107 ⇔ 114	Auto program 13
			115 ⇔ 122	Auto program 14
			123 ⇔ 130	Auto program 15
			131 ⇔ 138	Auto program 16
			139 ⇔ 146	Auto program 17
			147 ⇔ 154	Auto program 18
			155 ⇔ 162	Auto program 19
			163 ⇔ 170	Auto program 20
			171 ⇔ 178	Auto program 21
			179 ⇔ 186	Auto program 22
			187 ⇔ 194	Auto program 23
			185 ⇔ 202	Auto program 24
			203 ⇔ 225	Auto program 25
-	9	Auto Speed	000 ⇔ 255	Auto speed, slow to fast
-	10	Foreground color dimmer (when Ch8 is 010–255)	000 ⇔ 255	0–100%

4Ch	15Ch	Function	Value	Percent/Setting
-	11	Foreground color (when Ch8 is 010–255)	000 ⇄ 013	Red
			014 ⇄ 027	Green
			028 ⇄ 041	Blue
			042 ⇄ 055	White
			056 ⇄ 069	Green + Blue
			070 ⇄ 083	Red + Blue
			084 ⇄ 097	Red + Green
			098 ⇄ 111	Red + Green + Blue
			112 ⇄ 125	Red + White
			126 ⇄ 139	Green + White
			140 ⇄ 153	Blue + White
			154 ⇄ 167	Red + Green + White
			168 ⇄ 181	Red + Blue + White
			182 ⇄ 195	Green + Blue + White
			196 ⇄ 209	R + G + B + W
210 ⇄ 223	2800K			
224 ⇄ 237	7000K			
238 ⇄ 255	Auto			
-	12	Background color dimmer (when Ch8 is 010–255)	000 ⇄ 255	0–100%
-	13	Background color (when Ch8 is 010–255)	000 ⇄ 013	Red
			014 ⇄ 027	Green
			028 ⇄ 041	Blue
			042 ⇄ 055	White
			056 ⇄ 069	Green + Blue
			070 ⇄ 083	Red + Blue
			084 ⇄ 097	Red + Green
			098 ⇄ 111	Red + Green + Blue
			112 ⇄ 125	Red + White
			126 ⇄ 139	Green + White
			140 ⇄ 153	Blue + White
			154 ⇄ 167	Red + Green + White
			168 ⇄ 181	Red + Blue + White
			182 ⇄ 195	Green + Blue + White
			196 ⇄ 209	R + G + B + W
210 ⇄ 223	2800K			
224 ⇄ 237	7000K			
238 ⇄ 255	Auto			
-	14	Dimmer speed mode	000 ⇄ 101	Off
			102 ⇄ 152	Dimmer speed mode 1 (fastest)
			153 ⇄ 203	Dimmer speed mode 2
			204 ⇄ 255	Dimmer speed mode 3 (slowest)
-	15	Auto delay	000 ⇄ 255	0–100%

94 Ch / 66 Ch / 34 Ch / 18 Ch

18Ch	34Ch	66Ch	94Ch	Function	Value	Percent/Setting
1	1	1	1	Dimmer	000 ⇄ 255	0-100%
2	2	2	2	Red 1	000 ⇄ 255	0-100%
3	3	3	3	Green 1	000 ⇄ 255	0-100%
4	4	4	4	Blue 1	000 ⇄ 255	0-100%
5	5	5	5	White 1	000 ⇄ 255	0-100%
6	6	6	6	Red 2	000 ⇄ 255	0-100%
7	7	7	7	Green 2	000 ⇄ 255	0-100%
8	8	8	8	Blue 2	000 ⇄ 255	0-100%
9	9	9	9	White 2	000 ⇄ 255	0-100%
10	10	10	10	Red 3	000 ⇄ 255	0-100%
11	11	11	11	Green 3	000 ⇄ 255	0-100%
12	12	12	12	Blue 3	000 ⇄ 255	0-100%
13	13	13	13	White 3	000 ⇄ 255	0-100%
14	14	14	14	Red 4	000 ⇄ 255	0-100%
15	15	15	15	Green 4	000 ⇄ 255	0-100%
16	16	16	16	Blue 4	000 ⇄ 255	0-100%
17	17	17	17	White 4	000 ⇄ 255	0-100%
-	18	18	18	Red 5	000 ⇄ 255	0-100%
	19	19	19	Green 5	000 ⇄ 255	0-100%
	20	20	20	Blue 5	000 ⇄ 255	0-100%
	21	21	21	White 5	000 ⇄ 255	0-100%
	22	22	22	Red 6	000 ⇄ 255	0-100%
	23	23	23	Green 6	000 ⇄ 255	0-100%
	24	24	24	Blue 6	000 ⇄ 255	0-100%
	25	25	25	White 6	000 ⇄ 255	0-100%
	26	26	26	Red 7	000 ⇄ 255	0-100%
	27	27	27	Green 7	000 ⇄ 255	0-100%
	28	28	28	Blue 7	000 ⇄ 255	0-100%
	29	29	29	White 7	000 ⇄ 255	0-100%
30	30	30	Red 8	000 ⇄ 255	0-100%	
31	31	31	Green 8	000 ⇄ 255	0-100%	
32	32	32	Blue 8	000 ⇄ 255	0-100%	
33	33	33	White 8	000 ⇄ 255	0-100%	
-	34	34	34	Red 9	000 ⇄ 255	0-100%
	35	35	35	Green 9	000 ⇄ 255	0-100%
	36	36	36	Blue 9	000 ⇄ 255	0-100%
	37	37	37	White 9	000 ⇄ 255	0-100%
	38	38	38	Red 10	000 ⇄ 255	0-100%
	39	39	39	Green 10	000 ⇄ 255	0-100%
	40	40	40	Blue 10	000 ⇄ 255	0-100%
	41	41	41	White 10	000 ⇄ 255	0-100%
	42	42	42	Red 11	000 ⇄ 255	0-100%
	43	43	43	Green 11	000 ⇄ 255	0-100%
	44	44	44	Blue 11	000 ⇄ 255	0-100%
	45	45	45	White 11	000 ⇄ 255	0-100%
	46	46	46	Red 12	000 ⇄ 255	0-100%

18Ch	34Ch	66Ch	94Ch	Function	Value	Percent/Setting
		47	47	Green 12	000 ⇄ 255	0-100%
		48	48	Blue 12	000 ⇄ 255	0-100%
		49	49	White 12	000 ⇄ 255	0-100%
		50	50	Red 13	000 ⇄ 255	0-100%
		51	51	Green 13	000 ⇄ 255	0-100%
		52	52	Blue 13	000 ⇄ 255	0-100%
		53	53	White 13	000 ⇄ 255	0-100%
		54	54	Red 14	000 ⇄ 255	0-100%
		55	55	Green 14	000 ⇄ 255	0-100%
		56	56	Blue 14	000 ⇄ 255	0-100%
		57	57	White 14	000 ⇄ 255	0-100%
		58	58	Red 15	000 ⇄ 255	0-100%
		59	59	Green 15	000 ⇄ 255	0-100%
		60	60	Blue 15	000 ⇄ 255	0-100%
		61	61	White 15	000 ⇄ 255	0-100%
		62	62	Red 16	000 ⇄ 255	0-100%
		63	63	Green 16	000 ⇄ 255	0-100%
		64	64	Blue 16	000 ⇄ 255	0-100%
		65	65	White 16	000 ⇄ 255	0-100%
		66		Red 17	000 ⇄ 255	0-100%
		67		Green 17	000 ⇄ 255	0-100%
		68		Blue 17	000 ⇄ 255	0-100%
		69		White 17	000 ⇄ 255	0-100%
		70		Red 18	000 ⇄ 255	0-100%
		71		Green 18	000 ⇄ 255	0-100%
		72		Blue 18	000 ⇄ 255	0-100%
		73		White 18	000 ⇄ 255	0-100%
		74		Red 19	000 ⇄ 255	0-100%
		75		Green 19	000 ⇄ 255	0-100%
		76		Blue 19	000 ⇄ 255	0-100%
		77		White 19	000 ⇄ 255	0-100%
		78		Red 20	000 ⇄ 255	0-100%
		79		Green 20	000 ⇄ 255	0-100%
		80		Blue 20	000 ⇄ 255	0-100%
		81		White 20	000 ⇄ 255	0-100%
		82		Red 21	000 ⇄ 255	0-100%
		83		Green 21	000 ⇄ 255	0-100%
		84		Blue 21	000 ⇄ 255	0-100%
		85		White 21	000 ⇄ 255	0-100%
		86		Red 22	000 ⇄ 255	0-100%
		87		Green 22	000 ⇄ 255	0-100%
		88		Blue 22	000 ⇄ 255	0-100%
		89		White 22	000 ⇄ 255	0-100%
		90		Red 23	000 ⇄ 255	0-100%
		91		Green 23	000 ⇄ 255	0-100%
		92		Blue 23	000 ⇄ 255	0-100%
		93		White 23	000 ⇄ 255	0-100%

18Ch	34Ch	66Ch	94Ch	Function	Value	Percent/Setting
18	34	66	94	Strobe	000 ⇔ 010	No function
					011 ⇔ 255	Strobe, slow to fast

Standalone Configuration

Set the product in one of the standalone modes to operate without a DMX controller.



Never connect a product that is operating in any standalone mode to a DMX string connected to a DMX controller. Products in standalone mode may transmit DMX signals that could interfere with the DMX signals from the controller.

Static Color Mode

To operate the FLEXstand FX ILS using a static color:

1. Press **<MENU>** repeatedly until **C--** shows on the display.
2. Press **<ENTER>**.
3. Use **<UP>** or **<DOWN>** to select the desired static color, from **C1–C20**.
4. Press **<ENTER>**.

Automatic Program

To operate the FLEXstand FX ILS using an automatic program:

1. Press **<MENU>** repeatedly until **P--** shows on the display.
2. Press **<ENTER>**.
3. Use **<UP>** or **<DOWN>** to select an automatic program, from **P1–P25**.
4. Press **<ENTER>**.

Auto Program Speed

To adjust the speed of an automatic program on the FLEXstand ILS:

1. Press **<MENU>** repeatedly until **S--** shows on the display.
2. Use **<UP>** or **<DOWN>** to increase or decrease the speed, from **P1–P25**.
3. Press **<ENTER>**.

Sound-Active Mode

To operate the FLEXstand FX ILS using a sound-active program:

1. Press **<MENU>** repeatedly until **Snd** shows on the display.
2. Press **<ENTER>**.
3. Use **<UP>** or **<DOWN>** to select the direction in which LEDs respond: **Snd1** (top-to-bottom), **Snd2** (bottom-to-top), or **Snd3** (bi-directional).
4. Press **<ENTER>**.
5. Use **<UP>** or **<DOWN>** to select the desired static color, from **C1–C20**.
6. Press **<ENTER>**.

Sound Sensitivity

To set the sound sensitivity of the product, do the following:

1. Press **<MENU>** repeatedly until **SEnS** shows on the display.
2. Use **<UP>** or **<DOWN>** to select the direction in which LEDs respond: **Snd1** (top-to-bottom), **Snd2** (bottom-to-top), or **Snd3** (bi-directional).
3. Press **<ENTER>**.
4. Use **<UP>** or **<DOWN>** to select the desired static color, from **C1–C20**.
5. Press **<ENTER>**.



The product will only respond to low frequencies of music (bass and drums).

Custom Color Mixing

To operate the FLEXstand FX ILS using a custom static color:

1. Press **<MENU>** repeatedly until **U--** shows on the display.
2. Press **<ENTER>**.
3. Press **<ENTER>** to cycle through the options, **r_ _ _** (red), **G_ _ _** (green), **b_ _ _** (blue), **U_ _ _** (white).
4. Use **<UP>** or **<DOWN>** to increase or decrease the selected value from **000–255**.
5. Repeat steps 3-4 until the product output is set as desired.

Dimmer

To set the dimmer value on the FLEXstand FX ILS:

1. Press **<MENU>** repeatedly until **diM** shows on the display.
2. Press **<ENTER>**.
3. Use **<UP>** or **<DOWN>** to set the dimmer speed, from **diM1** (fast) to **diM3** (slow) or **oFF**.
4. Press **<ENTER>**.

Factory Reset

To reset the FLEXstand FX ILS to default factory settings:

1. Press **<MENU>** repeatedly until **SEt** shows on the display.
2. Press **<ENTER>**.
3. Use **<UP>** or **<DOWN>** to select **rEst**.
4. Press **<ENTER>**.
5. Use **<UP>** or **<DOWN>** to select **yES**.
6. Press **<ENTER>**.

Wired Master/Slave Mode

The Master/Slave mode allows a single FLEXstand FX ILS product (the “master”) to control the actions of one or more FLEXstand FX ILS products (the “slaves”) without the need of a DMX controller. The master product will be set to operate in either standalone mode or with the IRC-6, while the slave products will be set to operate in slave mode. Once set and connected, the slave products will operate in unison with the master product.

Configure the products as indicated below.

Slave products:

1. Press **<MENU>** repeatedly until **4Ch** shows on the display.
2. Press **<ENTER>**.
3. Use **<UP>** or **<DOWN>** to set the starting address to **d 1**.
4. Press **<ENTER>**.
5. Connect the DMX input of the first slave product to the DMX output of the master product.
6. Connect the DMX input of the subsequent slave products to the DMX output of the previous slave product.
7. Finish setting and connecting all the slave products.

Master product:

1. Set the master product to operate in standalone mode or with the IRC-6.
2. Make the master product the first product in the DMX daisy chain.



- **Configure all the slave products before connecting the master to the daisy chain.**
- **Never connect a DMX controller to a DMX string configured for Master/Slave operation because the controller may interfere with the signals from the master.**
- **Do not connect more than 31 slaves to the master.**

D-Fi USB Master/Slave Mode

The D-Fi USB allows a single FLEXstand FX ILS product (the “master”) to control the actions of one or more FLEXstand FX ILS products (the “slaves”) without the need of a DMX controller or DMX cables. The master (transmitter) product will be set to operate in standalone mode, while the slave (receiver) products will be set to operate in slave mode. Once set and connected, the slave products will operate in unison with the master product.

Configure the products as indicated below.

Slave products:

1. Press **<MENU>** repeatedly until **4Ch** shows on the display.
2. Press **<ENTER>**.
3. Use **<UP>** or **<DOWN>** to set the starting address to **d 1**.
4. Press **<ENTER>**.
5. Set the D-Fi USB to receive on a specific channel, 1–16.
6. Plug in the D-Fi USB.
7. Finish setting and connecting all the slave products.

Master product:

1. Set the master product to operate in standalone mode.
2. Set the D-Fi USB to transmit on the D-Fi channel the slaves are receiving on.
3. Plug in the D-Fi USB.



- **All products must be set to the same DMX personality, DMX address, and D-Fi channel.**
- **Configure all the slave products before configuring the master to transmit.**
- **Never connect a DMX controller to a D-Fi channel configured for Master/Slave operation because the controller may interfere with the signals from the master.**

ILS Mode

ILS (Integrated Lighting System) provides 2 modes that synchronize with the GigBAR MOVE+ILS: Mode 1 synchronizes with side 1 of the GigBAR MOVE+ILS and Mode 2 synchronizes with side 2 of the GigBAR MOVE+ILS. When linked, effects will sync with the most similar effect on the selected side of the GigBAR MOVE+ILS: Kinta effects will sync with one of the kintas, moving heads will sync with one of the moving heads, and wash effects will sync with one of the pars. Laser effects will sync with the laser, and strobe effects will sync with the strobe effects regardless of ILS mode.

This product will synchronize with the par effect on the selected side of the GigBAR MOVE+ILS.

To set the FLEXstand FX ILS to respond to an ILS signal:

1. Press **<MENU>** repeatedly until **iLS** shows on the display.
2. Use **<UP>** or **<DOWN>** to select from **iLS1** (side 1) or **iLS2** (side 2)
3. Press **<ENTER>**.

RFC Remote Control

The FLEXstand FX ILS can be operated with an RFC remote or an RFC-XL remote (sold separately).



For more information about using an RFC or RFC-XL remote, download the user manuals from www.chauvetdj.com

RFC Remote Binding

To enable RF control, the product must bind to the RFC/RFC-XL. To bind the FLEXstand FX ILS to an RFC/RFC-XL, follow the instructions below:

1. Press **<MENU>** repeatedly until **SEt** shows on the display.
2. Press **<ENTER>**.
3. Use **<UP>** or **<DOWN>** to select **rF**.
4. Press **<ENTER>**.
5. Use **<UP>** or **<DOWN>** to select **LinK**.
6. Press **<ENTER>** and wait until the display text begins blinking.
7. Press and hold **<BLACK OUT>** on the RFC/RFC-XL until **SuCC** shows on the display.

RFC Control Options

The RFC-XL can control multiple products at once, whether in defined groups or in public mode. To set the FLEXstand FX ILS to public RFC/RFC-XL control:

1. Press **<MENU>** repeatedly until **SEt** shows on the display.
2. Press **<ENTER>**.
3. Use **<UP>** or **<DOWN>** to select **rF**.
4. Press **<ENTER>**.
5. Use **<UP>** or **<DOWN>** to select **PubL** (public mode).
6. Press **<ENTER>**.

To set the FLEXstand FX ILS to public RFC/RFC-XL control:

RFC Remote Control Operation

RFC	Button	Function
	<BLACK OUT>	Press to turn off all lights until the button is pressed again
	<STROBE>	Press to toggle strobe, then use <+> or <-> to increase or decrease strobe speed
	<DIMMER>	Press then use <+> or <-> to increase or decrease the dimmer
	<AUTO>	Press to activate automatic mode, then use <+> or <-> to select a program
	<SPD/SENS>	Press then use <+> or <-> to increase or decrease speed or sensitivity
	<SOUND>	Press to activate sound-active mode, then use <+> or <-> to select a program
	<->	Press to decrease speed, sensitivity, or the dimmer/color value, or to scroll down the list of programs
	<+>	Press to increase speed, sensitivity, or the dimmer/color value, or to scroll up the list of programs
	<FREEZE>	Press to stop all movement and color chasing
	<R>	In manual mode, press then use <+> or <-> to increase or decrease the red value
	<G>	In manual mode, press then use <+> or <-> to increase or decrease the green value
		In manual mode, press then use <+> or <-> to increase or decrease the blue value
	<W>	In manual mode, press then use <+> or <-> to increase or decrease the UV value
	<UV>	In manual mode, press then use <+> or <-> to increase or decrease the white value
	<FADE/SNAP>	Press to toggle between fade and snap programs
	<MANUAL>	Press to activate manual mode
	<PRESET/COLOR>	Press to activate presets/colors, then use <+> or <-> to select a preset/color

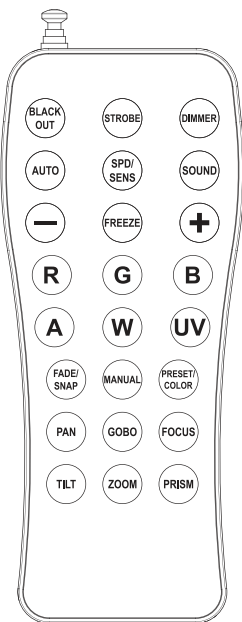

The RFC remote will not respond to any inputs when Freeze or Black Out is activated. If the remote does not respond when a button is pressed, try pressing **<FREEZE>** or **<BLACK OUT>**. Freeze or Black Out may have been inadvertently activated.

RFC-XL Remote Control Operation

RFC	Button	Function
	<ON/OFF>	Press to power the RFC-XL on or off
	Color picker	Use to select a color (does not correspond to colors printed on remote)
	<GROUP>	Press to cycle between groups 1–4 and public mode
	<BLACK OUT>	Press to turn off all lights until the button is pressed again
	<AUTO>	Press to activate automatic mode, then use <^> or <v> to select a program
	<FADE>	Press to toggle between fade and snap programs
	<SOUND>	Press to activate sound-active mode, then use <^> or <v> to select a program
	<SPEED/ SENSITIVITY>	Press then use <^> or <v> to increase or decrease speed or sensitivity
	<^>	Press to increase the selected value, or to scroll up the list of options
	<v>	Press to decrease the selected value, or to scroll down the list of options
	<STROBE>	Press to toggle strobe, then use <^> or <v> to increase or decrease strobe speed
	<DIMMER>	Press then use <^> or <v> to increase or decrease the dimmer
	<RED>	In manual mode, press then use <^> or <v> to increase or decrease the red value
	<GREEN>	In manual mode, press then use <^> or <v> to increase or decrease the green value
	<BLUE>	In manual mode, press then use <^> or <v> to increase or decrease the blue value
	<WHITE>	In manual mode, press then use <^> or <v> to increase or decrease the white value
	<COLOR>	Press to activate colors, then use <^> or <v> or the color picker to select a color
	<FREEZE>	Press to stop all movement and color chasing



The RFC-XL remote will not respond to any inputs when Black Out is activated. If the remote does not respond when a button is pressed, try pressing <BLACK OUT>. You may have inadvertently activated Black Out.

5. Maintenance

Product Maintenance

Dust build-up reduces light output performance and can cause overheating. This can lead to reduction of the light source's life and/or mechanical wear. To maintain optimum performance and minimize wear, clean all lighting products at least twice a month. However, be aware that usage and environmental conditions could be contributing factors to increase the cleaning frequency.

To clean the product, follow the instructions below:

1. Unplug the product from power.
2. Wait until the product is at room temperature.
3. Use a vacuum (or dry compressed air) and a soft brush to remove dust collected on the external surfaces.
4. Clean all transparent surfaces with a mild soap solution, ammonia-free glass cleaner, or isopropyl alcohol.
5. Apply the solution directly to a soft, lint free cotton cloth or a lens cleaning tissue.
6. Softly drag any dirt or grime to the outside of the transparent surface.
7. Gently polish the transparent surfaces until they are free of haze and lint.



Always dry the transparent surfaces carefully after cleaning them.

6. Technical Specifications

Dimensions and Weight

Extension Pole				
Height (mounted)	Diameter (Top)	Diameter (Middle)	Diameter (Bottom)	Weight
4.8 to 8 ft (1.5 to 2.4m)	1.34 in (34 mm)	1.7 in (44 mm)	2 in (50 mm)	8.2 lb (3.7 kg)

Base		
Length	Width	Weight
21.7 in (55 cm)	21.6 in (54.7 cm)	34.2 lb (16 kg)

Capacity and Compatibility

Load Capacity	Threaded Insert (Pole Top)	Threaded Insert (Base)
132 lb (60 kg)	M10-1.5 TPI	M10-1.5 TPI

Power

Power Supply Type	Range	Voltage Selection
Switching (internal)	100 to 240 VAC, 50/60 Hz	Auto-ranging

Parameter	120 V, 60 Hz	230 V, 50 Hz
Consumption	15 W	15 W
Operating Current	0.3 A	0.2 A
Power linking current (products)	8 A (34 products)	8 A (47 products)
Fuse	T1A, 250V	T1A, 250V

Power I/O	U.S./Worldwide	UK/Europe
Power input connector	IEC	IEC
Power output connector	Edison	IEC
Power cable plug	Edison (U.S.)	Local Plug

Light Source

Type	Color	Quantity	Power	Lifespan
LED	Quad (RGB+WW)	68	0.8 W	50,000 hours

Photometrics

PWM Frequency	Strobe Rate
5000 Hz	0 to 20 Hz

Thermal

Maximum External Temperature	Cooling System
104 °F (40 °C)	Convection

DMX

I/O Connector	Channel Range
3-pin XLR	4, 15, 18, 34, 66, or 94

Ordering

Product Name	Item Code	UPC Number
FLEXstand FX ILS	10112628	781462229764



Contact Us

General Information	Technical Support
Chauvet World Headquarters	
Address: 3360 Davie Rd., Suite 509 Davie, FL 33314 Voice: (954) 577-4455 Fax: (954) 929-5560 Toll Free: (800) 762-1084	Voice: (844) 393-7575 Fax: (954) 756-8015 Email: chauvetcs@chauvetlighting.com Website: www.chauvetdj.com
Chauvet U.K.	
Address: Pod 1 EVO Park Little Oak Drive, Sherwood Park Nottinghamshire, NG15 0EB UK Voice: +44 (0) 1773 511115 Fax: +44 (0) 1773 511110	Email: UKtech@chauvetlighting.eu Website: www.chauvetdj.eu
Chauvet Benelux	
Address: Vaartlaan 9 9800 Deinze Belgium Voice: +32 9 388 93 97	Email: BNLtech@chauvetlighting.eu Website: www.chauvetdj.eu
Chauvet France	
Address: 3, Rue Ampère 91380 Chilly-Mazarin France Voice: +33 1 78 85 33 59	Email: FRtech@chauvetlighting.fr Website: www.chauvetdj.eu
Chauvet Germany	
Address: Bruno-Bürgel-Str. 11 28759 Bremen Germany Voice: +49 421 62 60 20	Email: DEtech@chauvetlighting.de Website: www.chauvetdj.eu
Chauvet Mexico	
Address: Av. de las Partidas 34 - 3B (Entrance by Calle 2) Zona Industrial Lerma Lerma, Edo. de México, CP 52000 Voice: +52 (728) 690-2010	Email: servicio@chauvet.com.mx Website: www.chauvetdj.mx

Warranty & Returns

For warranty terms and conditions and return information, please visit our website.

For customers in the United States and Mexico: www.chauvetlighting.com/warranty-registration.

For customers in the United Kingdom, Republic of Ireland, Belgium, the Netherlands, Luxembourg, France, and Germany: www.chauvetlighting.eu/warranty-registration.