

Pronomic SPS-1 Boxenstative

ArtNr.: 00016444, 00016445, 00085601, 00090585

Vielen Dank, dass Sie sich für unser Boxenstativ entschieden haben. Um sicherzustellen, dass Sie mit diesem Produkt voll und ganz zufrieden sind, lesen Sie sorgfältig und verstehen Sie diese Bedienungsanleitung, bevor Sie unser Produkt verwenden. Bewahren Sie diese Bedienungsanleitung an einem sicheren Ort auf. Die Bedienungsanleitung muss an alle nachfolgenden Anwender weitergegeben werden.



Bitte Sicherheitshinweise beachten!



WARNUNG

Mit dem Signalwort **WARNUNG** sind die Gefahren gekennzeichnet, die ohne Vorsichtsmaßnahmen zu schweren Verletzungen führen können.



HINWEIS

Alle personenbezogenen Formulierungen in dieser Bedienungsanleitung sind geschlechtsneutral zu betrachten.

Alle Informationen in dieser Bedienungsanleitung wurden nach bestem Wissen und Gewissen kontrolliert. Weder Autor noch Herausgeber können jedoch für Schäden haftbar gemacht werden, die in Zusammenhang mit der Verwendung dieser Bedienungsanleitung stehen.

Sonstige, in diesem Dokument aufgeführte Produkt-, Marken- und Unternehmensbezeichnungen können die Warenzeichen ihrer jeweiligen Eigentümer sein. Die Einhaltung sämtlicher anwendbarer Urheberrechtsgesetze liegt in der Verantwortung des Anwenders dieses Dokuments.



WARNUNG

Detaillierte Sicherheitshinweise:

Bitte beachten Sie die folgenden Sicherheitshinweise um Fehlfunktionen, Schäden oder Verletzungen zu vermeiden:

- Diese Artikel sind keine Kinderspielzeuge und sind für Kinder unter 3 Jahren nicht empfohlen. Lassen Sie Ihre Kinder nicht unbeaufsichtigt mit den Produkten spielen.
- Bitte zweckentfremden Sie das Boxenstativ nicht, z. B. als Werkzeug, Stiege etc. und belasten Sie das Stativ nur mit dem Maximalgewicht von 50 kg (zentrische Traglast). Bei der Verwendung von Boxentürmen ist es erforderlich, darauf zu achten, dass das Stativ nicht umkippen kann.
- Achten Sie beim Aufbau darauf, dass sich keine Gegenstände oder Gliedmaße zwischen den Stangen befinden. Unsachgemäße Handhabung kann zu eingeklemmten Gliedmaßen führen.
- Die Beine des Boxenstativs müssen so weit auseinanderstehen, dass ein Umkippen nicht möglich ist. Das Stativ ist nur für die Anwendung auf ebenem und festem Untergrund vorgesehen.
- Bitte sichern Sie das Rohr stets mit dem entsprechenden Splint.
- Vor der Benutzung ist eine entsprechende Sichtprüfung auf mechanischen Verschleiß vorzunehmen. Insbesondere ist auf deformierte Rohre und Streben, abgeplatzte Schellen oder ausgeleierte Nieten zu achten. Beschädigte Stative dürfen NICHT eingesetzt werden.

Alle technischen Daten und Erscheinungsbilder können ohne vorherige Ankündigung geändert werden. Alle Angaben waren zum Zeitpunkt der Drucklegung korrekt. Die Musikhaus Kirstein GmbH übernimmt keine Gewähr für die Richtigkeit oder Vollständigkeit der in diesem Handbuch enthaltenen Beschreibungen, Fotos oder Aussagen. Gedruckte Farben und Spezifikationen können geringfügig vom Produkt abweichen.

 **KIRSTEIN.de**
Musikhaus Kirstein GmbH

Bernbeurener Str. 11

86956 Schongau – Germany

Telefon/Phone: 0049-8861-909494-0

Pronomic SPS-1 speaker stands

ArtNo.: 00016444, 00016445, 00085601, 00090585

Thank you for purchasing our speaker stand. To ensure that you are fully satisfied with this product, please read and understand this instruction manual carefully before using our product. Keep these operating instructions in a safe place. The operating instructions must be passed on to all subsequent users.



Please observe the safety instructions!



The signal word WARNING indicates dangers that could lead to serious injury if precautions are not taken.



All personal formulations in these operating instructions are to be regarded as gender-neutral.

All information in these operating instructions has been checked to the best of our knowledge and belief. However, neither the author nor the publisher can be held liable for any damage arising in connection with the use of these operating instructions.

Other product, brand and company names mentioned in this document may be the trademarks of their respective owners. Compliance with all applicable copyright laws is the responsibility of the user of this document.



Detailed safety instructions:

Please observe the following safety instructions to avoid malfunctions, damage or injury:

- These items are not children's toys and are not recommended for children under 3 years of age. Do not allow your children to play with the products unsupervised.
- Please do not misuse the speaker stand, e.g. as a tool, staircase, etc. and only load the stand with the maximum weight of 50 kg (centric load capacity). When using speaker towers, it is necessary to ensure that the stand cannot tip over.
- When setting up, make sure that there are no objects or limbs between the poles. Improper handling can lead to trapped limbs.
- The legs of the speaker stand must be far enough apart to prevent it from tipping over. The stand is only intended for use on level and firm ground.
- Please always secure the tube with the appropriate split pin.
- Before use, carry out a visual inspection for mechanical wear. Pay particular attention to deformed tubes and struts, chipped clamps or worn rivets. Damaged stands must NOT be used.

All technical data and appearances are subject to change without prior notice. All information was correct at the time of printing. Musikhaus Kirstein GmbH accepts no liability for the accuracy or completeness of the descriptions, photos or statements contained in this manual. Printed colors and specifications may differ slightly from the product.

 **KIRSTEIN.de**
Musikhaus Kirstein GmbH

Bernbeurener Str. 11

86956 Schongau – Germany

Telefon/Phone: 0049-8861-909494-0



 **KIRSTEIN.de**
We love music!



excellent sound

- Sauerstofffreies Kupfer
- Hochdichter Kupferschild
- Hochflexibler und robuster Außenmantel
- Handgelötet
- Säure- und ölfest
- Spannzangen und Zugentlastung
- Niedrige Leiterkapazität
- 3 Jahre Garantie
- Oxygen free copper
- High density copper shield
- Highly flexible and durable
- Soldered by hand
- Acid and oil proof
- Chuck type strain relief
- Low capacitance
- 3 years warranty



FR

Cet appareil
se recycle

À DÉPOSER
EN MAGASIN

À DÉPOSER
EN DÉCHÈTERIE



OU



FR



Points de collecte sur www.quefairedemesdechets.fr
Privilégiez la réparation ou le don de votre appareil !



THUMP SUBGO

BATTERY-POWERED PORTABLE SUBWOOFER

OWNER'S MANUAL



Important Safety Instructions

1. Read these instructions.
2. Keep these instructions.
3. Heed all warnings.
4. Follow all instructions.
5. Do not use this apparatus near water.
6. Clean only with a dry cloth.
7. Do not block any ventilation openings. Install in accordance with the manufacturer's instructions.
8. Do not install near any heat sources such as radiators, heat registers, stoves, or other apparatus (including amplifiers) that produce heat.
9. Protect the power cord from being walked on or pinched particularly at plugs, convenience receptacles, and the point where they exit from the apparatus.
10. Only use attachments/accessories specified by the manufacturer.
11. Use only with a cart, stand, tripod, bracket, or table specified by the manufacturer, or sold with the apparatus. The apparatus may also be placed on the ground in wedge position. When a cart is used, use caution when moving the cart/apparatus combination to avoid injury from tip-over.
12. Unplug this apparatus during lightning storms or when unused for long periods of time.
13. Refer all servicing to qualified service personnel. Servicing is required when the apparatus has been damaged in any way, such as power-supply cord or plug is damaged, liquid has been spilled or objects have fallen into the apparatus, the apparatus has been exposed to rain or moisture, does not operate normally, or has been dropped.
14. This apparatus shall not be exposed to dripping or splashing, and no object filled with liquids, such as vases or beer glasses, shall be placed on the apparatus.
15. Do not overload wall outlets and extension cords as this can result in a risk of fire or electric shock.
16. **NOTE:** This equipment has been tested and found to comply with the limits for a Class B digital device, pursuant to part 15 of the FCC Rules. These limits are designed to provide reasonable protection against harmful interference in a residential installation. This equipment generates, uses, and can radiate radio frequency energy and, if not installed and used in accordance with the instructions, may cause harmful interference to radio communications. However, there is no guarantee that interference will not occur in a particular installation. If this equipment does cause harmful interference to radio or television reception, which can be determined by turning the equipment off and on, the user is encouraged to try to correct the interference by one or more of the following measures:



- Reorient or relocate the receiving antenna.
- Increase the separation between the equipment and the receiver.
- Connect the equipment into an outlet on a circuit different from that to which the receiver is connected.
- Consult the dealer or an experienced radio/TV technician for help.

CAUTION: Changes or modifications to this device not expressly approved by LOUD Audio, LLC could void the user's authority to operate the equipment under FCC rules.

CAUTION

RISK OF ELECTRIC SHOCK! DO NOT OPEN!

CAUTION: TO REDUCE THE RISK OF ELECTRIC SHOCK DO NOT REMOVE COVER (OR BACK). NO USER-SERVICEABLE PARTS INSIDE. REFER SERVICING TO QUALIFIED PERSONNEL.

The lightning flash with arrowhead symbol within an equilateral triangle is intended to alert the user to the presence of uninsulated "dangerous voltage" within the product's enclosure, that may be of significant magnitude to constitute a risk of electric shock to persons.

The exclamation point within an equilateral triangle is intended to alert the user of the presence of important operating and maintaining (servicing) instructions in the literature accompanying the appliance.

CAUTION — A battery subjected to extremely low air pressure may result in an explosion or the leakage of flammable liquid or gas.

WARNING — The battery (battery or batteries or battery pack) shall not be exposed to excessive heat such as sunshine, fire or the like.

17. Any changes or modifications not expressly approved by the party responsible for compliance could void the user's authority to operate the equipment. This equipment complies with FCC radiation exposure limits set forth for an uncontrolled environment. This equipment should be installed and operated with minimum distance 20cm between the radiator & your body.
18. For pluggable equipment, the socket-outlet shall be easily accessible.
19. The maximum ambient temperature during use of the appliance must not exceed 45° C. Approved for safe operation only at altitudes below 2000 meters above sea level (ASL).
20. This equipment complies with FCC and ICED radiation exposure limits set forth for an uncontrolled environment. This equipment should be installed and operated with minimum distance 20cm between the radiator & your body.
Cet équipement est conforme aux limites d'exposition au rayonnement ICED établies pour un environnement non contrôlé. Cet équipement doit être installé et utilisé à une distance minimale de 20 cm entre le radiateur et votre corps.
Operation frequency: 2402–2480MHz
21. This apparatus has been designed with Class-I construction and must be connected to a mains socket outlet with a protective earthing connection (the third grounding prong).
22. This apparatus does not exceed the Class A/Class B (whichever is applicable) limits for radio noise emissions from digital apparatus as set out in the radio interference regulations of the Canadian Department of Communications.

ATTENTION — *Le présent appareil numérique n'émet pas de bruits radioélectriques dépassant les limites applicables aux appareils numériques de class A/de class B (selon le cas) prescrites dans le règlement sur le brouillage radioélectrique édicté par les ministere des communications du Canada.*

23. This device complies with Part 15 of the FCC Rules [and contains license-exempt transmitter(s)/receiver(s) that comply with Innovation, Science and Economic Development Canada's license-exempt RSS(s)]. Operation is subject to the following two conditions:
 - (1) this device may not cause harmful interference, and
 - (2) this device must accept any interference received, including interference that may cause undesired operation.

L'émetteur/récepteur exempt de licence contenu dans le présent appareil est conforme aux CNR d'Innovation, Sciences et Développement économique Canada applicables aux appareils radio exempts de licence. L'exploitation est autorisée aux deux conditions suivantes:

- (1) l'appareil ne doit pas produire de brouillage, et
- (2) l'appareil doit accepter tout brouillage radioélectrique subi, même si le brouillage est susceptible d'en compromettre le fonctionnement.

24. Exposure to extremely high noise levels may cause permanent hearing loss. Individuals vary considerably in susceptibility to noise-induced hearing loss, but nearly everyone will lose some hearing if exposed to sufficiently intense noise for a period of time. The U.S. Government's Occupational Safety and Health Administration (OSHA) has specified the permissible noise level exposures shown in the following chart.

According to OSHA, any exposure in excess of these permissible limits could result in some hearing loss. To ensure against potentially dangerous exposure to high sound pressure levels, it is recommended that all persons exposed to equipment capable of producing high sound pressure levels use hearing protectors while the equipment is in operation. Ear plugs or protectors in the ear canals or over the ears must be worn when operating the equipment in order to prevent permanent hearing loss if exposure is in excess of the limits set forth here:

Duration, per day in hours	Sound Level dBA, Slow Response	Typical Example
8	90	Duo in small club
6	92	
4	95	Subway Train
3	97	
2	100	Very loud classical music
1.5	102	
1	105	Ty screaming at Troy about deadlines
0.5	110	
0.25 or less	115	Loudest parts at a rock concert

CAUTION — Danger of explosion if battery is incorrectly replaced. Replace only with the same or equivalent type.

WARNING — To reduce the risk of fire or electric shock, do not expose this apparatus to rain or moisture.

CAUTION — To prevent electric shock hazard, do not connect to mains power supply while grille is removed.

If the product is subjected to static electrical interference, it is necessary to manually restart the product which is within the design scope of the product.

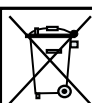

Correct disposal of this product: This symbol indicates that this product should not be disposed of with your household waste, according to the WEEE directive (2012/19/EU) and your national law. This product should be handed over to an authorized collection site for recycling waste electrical and electronic equipment (EEE). Improper handling of this type of waste could have a possible negative impact on the environment and human health due to potentially hazardous substances that are generally associated with EEE. At the same time, your cooperation in the correct disposal of this product will contribute to the effective usage of natural resources. For more information about where you can drop off your waste equipment for recycling, please contact your local city office, waste authority, or your household waste disposal service.

Table of Contents

Important Safety Instructions.....2

Table of Contents3

Chapter 1 : Welcome.....5

Introduction.....5
Features5
Things to Remember.....5
About This Guide6
Getting Started.....6

Chapter 2 : ThumpSub GO Rear Panel Features7

Power Connector7
Power Switch.....7
XLR and 1/4" Combo Input Jacks.....8
XLR Output Jacks [Full Range and High Pass].....9
Main Volume Knob and SIG/OL LED.....10
High Pass Mode Switch.....10
Front LED Switch10
Phase Switch10
Output Mode Switch11
Bluetooth / Pair Switch and LED.....12
Battery Status LEDs12
Battery Replacement13

Chapter 3 : Placement and Polarity15

Placement15
The Ins and Outs of Polarity.....15
Polarity Waveforms15

Chapter 4 : Protection Circuitry 16

Introduction..... 16
 Overexcursion Protection 16
 Thermal Protection 16
 AC Power 16
 Care and Maintenance 16

Hookup Diagrams 17

Hookup Diagrams > Small Club System 17
Hookup Diagrams > Large Club System 18
Hookup Diagrams > DJ System..... 19
Hookup Diagrams > Daisy-Chaining Multiple ThumpSub GO Subwoofers..... 20

Appendix A : Service Information..... 21

Introduction..... 21
Troubleshooting..... 21
Repair 22

Appendix B : Technical Information 23

ThumpSub GO Specifications 23
ThumpSub GO Dimensions 26
ThumpSub GO Block Diagram 27

Warranty Statement 28

That's All, Folks!..... 29

Chapter 1 : Welcome

Introduction

Hello everyone! This is the ThumpSub GO Owner's Manual. This document contains detailed information about the ThumpSub GO... we hope you like it!

Mackie ThumpSub GO is a battery-powered portable subwoofer with a slim, ergonomic design that lets you pull off those iconic bass drops anywhere you GO—without needing a power outlet.

Get up to 12 hours of battery life* with two battery compartments, letting you hot swap batteries without losing power.

Connect your portable loudspeakers, like the Thump GO battery-powered loudspeaker, for a complete mono, stereo or zone PA system with deep bass.

Stream wirelessly through the whole system via Bluetooth®.

Carry the bass like a briefcase.

(*One battery included for up to 6 hours battery life. Optional second battery sold separately.)

If you have any questions or comments about this Owner's Manual (or other Mackie documentation), please don't hesitate to contact us:

- 1-800-898-3211 (Monday through Friday, normal business hours, Pacific Time)
- www.mackie.com/support-contact

Features

- Dual 8" woofers and 400W Class-D amp
- Two hot-swappable battery compartments
- Up to 12 hours battery life total (6 per battery)
- One GB-200 battery included
- Slim, ergonomic design is easy to carry
- Vertical or horizontal orientation
- Connect portable loudspeakers
- Bluetooth® streaming

Things to Remember

- Never listen to loud music for prolonged periods.
Please see the Safety Instructions on page 2 for information on hearing protection.
- Save the shipping boxes and packing materials! You may need them someday. Besides, the cats will love playing in them and jumping out at you unexpectedly. Remember to pretend like you are surprised!
- Save your sales receipt in a safe place.

About This Guide

This guide is designed to be accessible, with subsections as complete as practical to minimize having to electronically leaf back and forth looking for the whole story. The entire manual does not need to be read to figure out how to use ThumpSub GO.

As the saying goes, “a picture tells a 1000 words”. With that thought in mind, we added quite a few illustrations, screenshots, and other images throughout to accompany the text.



This icon marks information that is critically important or unique! For your own good, read and remember them.



There's an illustration of a microscope, so, of course, you're going to get more detailed information when you see this little guy. There are explanations of features and practical tips listed here.



It's a good idea to pay attention to text displayed next to a note icon, as this icon draws attention to certain features and functions relating to the usage of ThumpSub GO.

Getting Started

The following steps will help you set up the ThumpSub GO quickly. If you desire a more thorough walk-through of ThumpSub GO, there is a wealth of information on the following pages!

1. Read and understand the Important Safety Instructions on page 2.
2. Make all initial connections with the power switches OFF on all equipment.
Make sure the master volume, level, and gain controls are turned all the way down.
3. Connect the outputs from the mixing console (or other signal source) to the inputs on the rear panel of the subwoofer, then connect the outputs from the subwoofer to the inputs of the loudspeakers.
4. Make sure the subwoofer's level knob is set to “U” (unity gain).
5. Push the line cord securely into the subwoofer's/loudspeaker's IEC connectors and plug the other ends into grounded AC outlets. The subwoofer/loudspeaker may accept the appropriate voltage as indicated near the IEC connector.

There are also two hidden compartments on the bottom of the ThumpSub GO to place batteries.
Read more about them on pages 13-14.

6. Turn the mixer (or other signal source) on.
7. Turn the subwoofer(s) on.
8. Turn the loudspeaker(s) on.
9. Be sure that the volume of the input is the same as it would be during normal use.
10. Start the signal source and raise the mixer's main L/R fader up to a comfortably loud listening level.

Chapter 2 : ThumpSub GO Rear Panel Features

Power Connector

This is a standard 3-prong IEC power connector. Connect the detachable power cord (included in the packaging with the subwoofer) to the power receptacle, and plug the other end of the power cord into an AC outlet.



VERY IMPORTANT Make sure that the AC power is matched to the AC power indicated on the rear panel (near the IEC receptacle).



Warning: Disconnecting the plug's ground pin is dangerous. Don't do it!



Power Switch

Press the top side of this rocker switch inwards to turn on the subwoofer. Press the bottom side of this rocker switch inwards to turn off the subwoofer.

As a general guide, the mixer (or other signal source) should be turned on first, subwoofers next, and loudspeakers last. As such, the loudspeakers should also be turned off first, followed by the subwoofers, then the mixer. This will reduce the possibility of any turn-on or turn-off thumps and other noises generated by any upstream equipment from coming out of the speakers.



XLR and 1/4" Combo Input Jacks

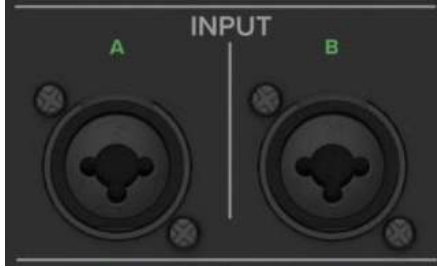

Inputs A and B may accept a balanced mic signal using an XLR connector.

They are wired as follows, according to standards specified by the AES (Audio Engineering Society).

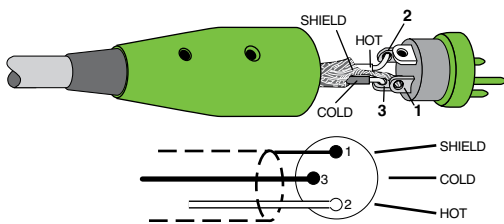

XLR Balanced Wiring:

- Pin 1 = Shield (ground)
- Pin 2 = Positive (+ or hot)
- Pin 3 = Negative (- or cold)



NEVER connect the output of an amplifier directly to a ThumpSub GO's input jack. This could damage the input circuitry and we wouldn't want that now, would we?

In addition to accepting a balanced mic signal using an XLR connector, these input channels may also accept 1/4" line-level signals driven by balanced or unbalanced sources.

To connect balanced lines to these inputs, use a 1/4" Tip-Ring-Sleeve (TRS) plug. "TRS" stands for Tip-Ring-Sleeve, the three connection points available on a stereo 1/4" or balanced phone jack or plug. TRS jacks and plugs are used for balanced signals and are wired as follows:

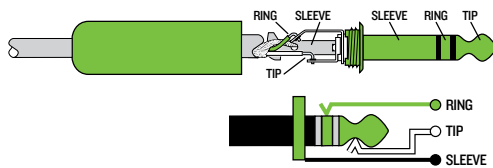

1/4" TRS Balanced Mono Wiring:

- Sleeve = Shield
- Tip = Hot (+)
- Ring = Cold (-)

To connect unbalanced lines to these inputs, use a 1/4" mono (TS) phone plug, wired as follows:

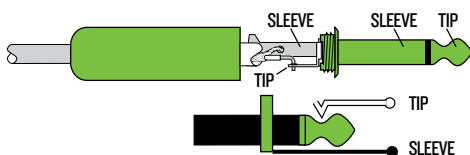

1/4" TS Unbalanced Mono Wiring:

- Sleeve = Shield
- Tip = Hot (+)



NEVER connect the output of an amplifier directly to a ThumpSub GO's input jack. This could damage the input circuitry and we wouldn't want that now, would we?

XLR Output Jacks [Full Range and High Pass]



This is a male XLR-type connector that produces the mix from the input jacks.

Depending on the position of the high pass mode switch (see next page), these outputs are typically connected to loudspeakers (high pass, switch down) or additional subwoofers (full range, switch up).



Please note that you can either use the High-Pass Outputs OR the Full Range Outputs, but not both simultaneously.

High Pass Output Mode:

Typically, full-range loudspeakers are connected to the high pass outputs to “split” the work with the subwoofer. The subwoofer handles all of the low frequencies and the loudspeakers handle the rest. As a result, it is more efficient and a bit louder.

Balanced XLR male connectors are provided for the line-level Ch. A and B high pass outputs. The subwoofer’s crossover splits the input signals into two frequency bands. The low frequency range goes to the internal amplifier that powers the subwoofer. The high frequency range is sent to these line-level output jacks.

The main volume and phase settings have no effect on the high pass outputs. The outputs are separate and maintain the stereo separation of the input signals.

Full Range Output Mode:

Typically, another powered subwoofer, powered loudspeakers, or an amplifier powering passive loudspeakers would need full range signal from the output of the first subwoofer in the signal chain. Balanced XLR male connectors are provided for the line-level Ch. A and B full range outputs.

The signal at these outputs is a direct copy of the input signals. These outputs allow you to daisy-chain multiple subwoofers and/or send the full range signals to other loudspeakers. It’s a great way to add side fills, too!

The output jacks are wired as follows, according to standards specified by the AES (Audio Engineering Society):

Balanced XLR Output Connector:

- Pin 1 – Shield (ground)
- Pin 2 – Positive (+ or hot)
- Pin 3 – Negative (– or cold)

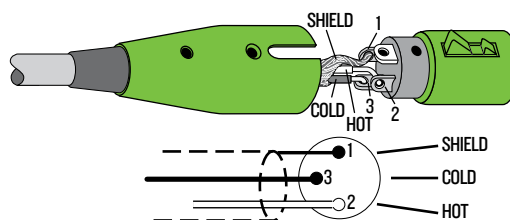

See page 20 to learn more about daisy-chaining ThumpSub GO subwoofers.

Main Volume Knob and Overload LED



The volume knob adjusts the overall signal level at the input to the built-in power amplifiers. It ranges from Off ($-\infty$) to a maximum gain of MAX.

The accompanying dual-colored LED will illuminate green when the input signal is present, indicating signal.

ThumpSub GO subwoofers have a built-in limiter that helps to prevent the amplifier outputs from clipping or overdriving the transducers. The overload LED illuminates red when the limiter is activated. It's okay for it to blink occasionally, but if it blinks frequently or lights continuously, turn down the volume of the input source until it only blinks occasionally.



Excessive limiting may lead to overheating, which in turn trips the thermal protect circuitry and interrupts the performance. See 'Thermal Protection' on page 16 for more information.

Located underneath the main volume knob and overload LED are four switches:

- High Pass Mode
- Front LED
- Phase
- Output Mode

Let's take a look at each of these four switches next to see what they do.

High Pass Mode Switch



Most subwoofers on the market – including those made by Mackie – feature a pair of full range output jacks and a pair of high pass output jacks. These are rarely, if ever, used simultaneously. If multiple subwoofers are daisy-chained (full range), the last one in line will connect to the main PA loudspeakers (high pass). This is why the ThumpSub GO features one pair of output jacks.

This switch allows you to choose whether the outputs are connected to additional subwoofers (full range) or loudspeakers (high pass). The output can be delivered in mono or stereo. Read more about the Output Mode Switch on the following page.



The High Pass Filter is applied to the output to optimize the pairing with any full range loudspeaker. It rolls off at 130 Hz at -6 dB with a slope of 24 dB/oct which forms a 4th-order Linkwitz-Riley crossover between the ThumpSub GO and connected loudspeaker.

Front LED Switch



There are two LEDs located on the front panel grille of each ThumpSub GO subwoofer. They are located on each side of the subwoofer and line up with the rotatable Running Man logo. These LEDs illuminate green when the front LED switch is engaged. Disengage the switch if you do not want the front panel LEDs to illuminate. We like to call this 'stealth' mode.

Phase Switch



This switch reverses the polarity of the signal going into the subwoofer amplifier by 180° . It has no effect on the signal at the outputs.

There is no right or wrong setting for this switch. Listen to the overall blend of the subwoofer with the rest of the system and select the switch position that gives you the best sound for your audience.

In fact, your system may vary when positioned differently and in alternate venues.

Don't be afraid to experiment with the position of the polarity switch. See page 15 for more information.

Output Mode Switch



The Output Mode Switch allows you to choose whether the A and B inputs are sent out separately [switch out] or as a mono sum of both inputs [switch in].

This is useful and saves the hassle of additional cable runs when connecting multiple (mono) subwoofers. Instead of running two cables from the first subwoofer to the next one, simply engage the switch and the signals from both inputs are combined.



When this switch is engaged [mono], the line output of the subwoofer is increased by +6 dB since the two input channels are summed together. If ThumpSub GO is daisy-chained and the switch is engaged [mono], the signal can be boosted too much, leading to distortion. We don't want that! The best way to alleviate this is by turning down the tops when in mono mode. Note that this only occurs when both inputs are utilized.

Not Uncle Bobby Bubba's Subwoofer [aka NUBBS]

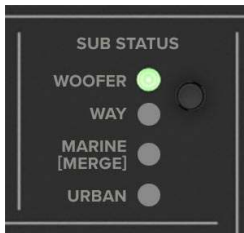

Everyone's got that Uncle Bobby Bubba. You know, 'the one with the PA for BBQs and such...' Maybe he goes by a different name, but we all know the guy. Well, ThumpSub GO is not from this universe, while Uncle Bobby Bubba's sub, sadly, remains grounded.

Q: How does ThumpSub GO differ from NUBBS?

A: Transportation. Yes, transportation. It's all about the SUB, we'll explain...

In addition to functioning as a subwoofer, ThumpSub GO also works like Transformers™ for transportation.

Perhaps you live in the SUBurbs and take the SUBway to the office? Go ahead and "transform" ThumpSub GO into a SUBway! Or if you prefer your own transportation, "transform" the ThumpSub GO SUBwoofer into a Chevrolet™ SUBurban™ or SUBaru™ and be on your way!

Do you like to take the family camping on long holiday weekends? If so, "transform" ThumpSub GO into a SUBmarine for fun lake excursions. The SUBmarine will stay afloat unless the button is long-pressed. When the button is long-pressed, the SUBmarine will SUBmerge.



Before SUBmerging, just make sure there are at least two adults on board.



When the SUBmarine is SUBmerged, the LED will illuminate blue. Otherwise, all LEDs here illuminate green when engaged.

In the end, though, ThumpSub GO works best as a SUBwoofer. In fact, some of ThumpSub GO's favorite songs are...

- SUBdivisions – RUSH
- SUBterranean Homesick Blues – Bob Dylan
- Anything by SUBlime

Bluetooth / Pair Switch and LED

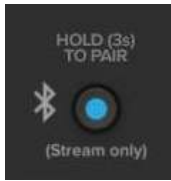

While not a “physical” connection, ThumpSub GO does have one additional “input”. It’s the Bluetooth channel and its volume is raised and lowered via the connected device.

This is how to connect a device to the ThumpSub GO via Bluetooth! Read on...

Upon powering up the ThumpSub GO, the Bluetooth function is either:

- (1) In sleep mode. See ‘Pairing and connecting for the first time’ (below) or...
- (2) ...Paired and connected. See ‘Previously paired and connected devices’ (also below).

Pairing and connecting for the first time:

To enter pairing mode, press and hold the pair switch down for at least three seconds. The LED will illuminate and slow flash blue for approximately 30 seconds while in pairing mode. [The LED will continue to flash until it has successfully paired and connected].

While ThumpSub GO is in pairing mode, simultaneously scan for Bluetooth devices on the device. You should see ThumpSub GO appear in the list of “available devices”. Select it by tapping it. From there, the Bluetooth device should indicate that it is successfully connected. Additionally, the pair switch will stop flashing and remain solid blue. If it does not, start the pairing process again, and make sure that the ThumpSub GO and device are both in pairing mode at the same time.

Previously paired and connected devices:

The Bluetooth connection will disconnect if it’s out of range or if the ThumpSub GO is powered off (including batteries). Previously paired and connected devices will automatically reconnect and the pair switch will once again illuminate a brilliant blue.



To drop the device from being paired with the ThumpSub GO, press and hold the ‘Bluetooth Pair’ switch down for at least three seconds.

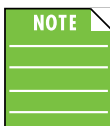

The Bluetooth connection may disconnect when affected by electrostatic discharge (ESD) or electrical fast transients (EFT). If this occurs, manually reconnect the Bluetooth connection.

Battery Status LEDs

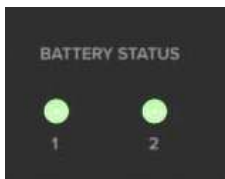

The battery status LEDs reflect the status of each battery located inside of the ThumpSub GO. They are tri-colored LEDs and display the remaining life of each battery.

The LEDs behave as follows:

- Green = 20%-100% battery remaining (aka “All Good”)
- Yellow = 5%-20% battery remaining (aka “Getting Sleepy”)
- Red = 5% or less battery remaining (aka “Charge Me”)
- Off = No battery detected (aka “No Battery”)



Battery Replacement

There are many reasons why you chose a ThumpSub GO. We'd like to think that one of those reasons is because a battery may be replaced while it's still pumping out low end! That's right, ThumpSub GO has two hot-swappable battery compartments, with each fully-charged battery lasting for up to six hours. Swapping out the batteries between compartments will not interrupt the audio so long as there's always one charged battery in a compartment. You're not taking a break, and neither should the subwoofer.

Dual Lithium-Ion batteries allow you to use ThumpSub GO without the need to be plugged in or wasting money on expensive batteries.



SAFETY FIRST: Before installing and using this product, please read these instructions carefully. Failure to follow the precautions may result in damage, injury, or even death. When installing this product, always respect the safety standard. Do not install the product in any way that is not described in these instructions.

1. The battery (battery or batteries or battery pack) shall not be exposed to excessive heat such as sunshine, fire, or the like.
2. Danger of explosion if battery is incorrectly replaced. Replace only with the same or equivalent type.
3. A battery subjected to extremely low air pressure may result in an explosion or the leakage of flammable liquid or gas.
4. No open flame sources, such as lighted candles, should be placed on the apparatus.

BATTERY / COVER REMOVAL INSTRUCTIONS:

Place the ThumpSub GO battery compartment side face up; ideally on a soft, flat surface.

Using a flathead or Phillips screwdriver, rotate the two locking tabs counter-clockwise. It should only be 1/4 to 1/2 a turn to unlock. Remove the battery compartment cover and set it aside, keeping in mind the position it was removed in.

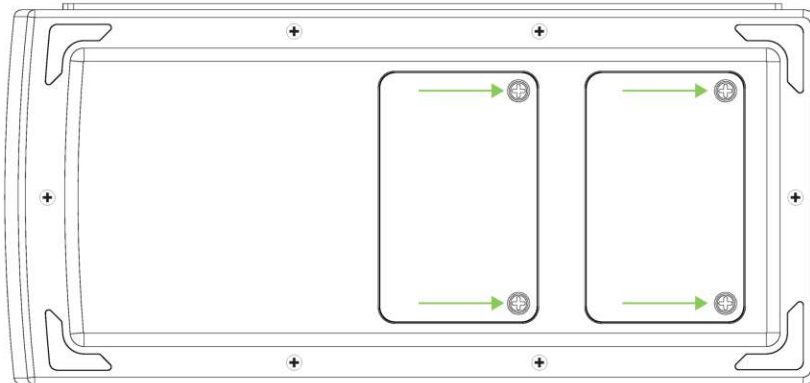

Shown below is the battery cover being removed. Remove the battery from captivity by lifting it straight up and out (towards you) to freedom.



BATTERY INSTALLATION INSTRUCTIONS:

Once the battery cover and battery have been removed and set aside, it's time to insert a charged one.



NOTE: Do not force the battery into place. There is only one way it fits and there should be no resistance during installation.



Power connector blades are located where the green circles are displayed above. Obviously, the one battery compartment is still closed (above-left), but when opened, the power connector blades will present themselves. Also of note is the green vertical rectangle on the battery (also above-left). This outlines where the power connectors are located on the battery and that they should align with the power connector blades of the ThumpSub GO subwoofer (above-right).

Line up the power connectors of the battery with the power connector blades of the ThumpSub GO and slowly release. Again, this is an easy process; no force is necessary.

Replace the battery cover and lock it to the ThumpSub GO by rotating the two locking tabs clockwise.

Once again, the power connectors on the battery that will align with the power connector blades inside of the ThumpSub GO battery compartment are displayed below inside of the green rectangle.



However, when not in use, a spare battery (purchased separately) may be charged via power cable. The battery will also charge while inside a plugged-in ThumpSub GO.

These are the most important battery specs to look for:

- 11.1V, 8800mAH 97.68Wh, 19V --- 3.0A
- **Size:** no larger than 3.1 in (79 mm) x 3.2 in (81 mm) x 4.9 in (124 mm)

Chapter 3 : Placement and Polarity

Placement

ThumpSub GO subwoofers are designed to sit on the floor or stage as the main PA, be it horizontal or vertical. They are not designed to be pole-mounted or suspended.

A socket is provided on top for mounting loudspeakers. The SPM400 is a great pole-mount option. See the hookup diagrams starting on page 17.



ThumpSub GO subwoofers have no rigging points and are not suitable for rigging. NEVER attempt to suspend a ThumpSub GO by its handles.

Check to make sure that the support surface (e.g. floor, etc.) has the necessary mechanical characteristics to support the weight of the subwoofer(s).

When pole-mounting loudspeakers, be sure that they are stabilized and secured from falling over or being accidentally pushed over. For stacked scenarios, it is highly suggested that straps are utilized. Failure to follow these precautions may result in damage to the equipment, personal injury, or death.

As with any powered components, protect them from moisture. Avoid installing a ThumpSub GO subwoofer in places exposed to harsh weather conditions. If you are setting them up outdoors, make sure they are under cover if you expect rain.

The Ins and Outs of Polarity

ThumpSub GO subwoofers include a switch that allows you to quickly invert the polarity of the subwoofer's output relative to the input signal it is receiving from the mixer or other sound source. But what exactly does that mean? A subwoofer works by literally pumping air as the woofer cone moves in and out with respect to the cabinet in which it is housed. It does so according to the low-frequency portion of the signal it receives from the sound source.

The woofer cone is simply following the waveform as seen in the sine wave in Figure 1. As the sine wave rises, the woofer cone pushes out. Likewise, as the sine wave falls, the woofer cone pulls into the cabinet. A musical signal is much more complex, of course, but the same principle applies. Movement of the woofer cone causes air pressure changes that we perceive as sound.

When the normal/invert [phase] switch is engaged, the original waveform is simply reversed 180° [see Figure 2]. Again, the subwoofer cone follows the waveform. However, this time the woofer cone starts by pulling into the cabinet followed by the woofer cone pushing out. If you have ever experimented with a subwoofer polarity switch, you may not have noticed any changes to the sound regardless of its position, especially if you are listening to just the subwoofer. This is normal, as our ears perceive them both at the same time.

The normal/invert [phase] switch comes into play when the subwoofer is paired with a loudspeaker. Ideally, the woofer cones of the subwoofer and full range loudspeaker would work together by pushing and pulling in unison. ThumpSub GO subwoofers are designed to be used in a broad range of applications. The flexibility provided by the polarity switch is necessary to ensure that you are receiving the best possible sound from your system, regardless of your setup.

Polarity Waveforms

Figure 1: Normal [0°]

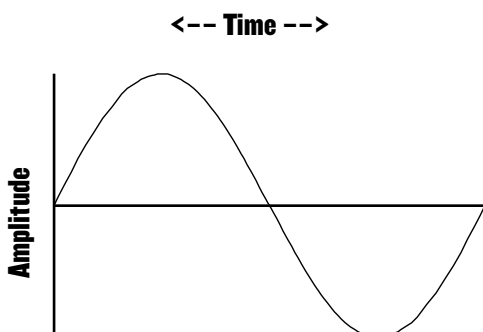
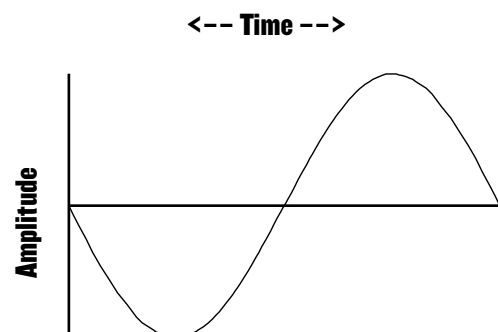

Figure 2: Invert [180°]



Chapter 4 : Protection Circuitry

Introduction

ThumpSub GO subwoofers employ a built-in limiter for less distortion at peak levels. A dynamic bass response circuit provides optimal low frequency response regardless of overall output level. Additional protection includes automatic thermal shutdown should the amp overheat. However, with Class-D amp technology, which is highly-efficient, this should never be a problem.



The protection circuits are designed to protect the subwoofers under reasonable and sensible conditions. Should you choose to ignore the warning signs [e.g. excessive distortion], you can still damage the woofer in the subwoofer by overdriving it past the point of amplifier clipping. Such damage is beyond the scope of the warranty.

Overexcursion Protection

A subsonic filter circuit just prior to the power amplifier prevents ultra-low frequencies from being amplified. Excessive low-frequency energy can damage the woofer by causing it to “bottom out,” also known as overexcursion, which is equivalent to a mechanical form of clipping.

Thermal Protection

All amplifiers produce heat. ThumpSub GO subwoofers are designed to be efficient both electrically and thermally. In the unlikely event of the amplifier overheating, a built-in thermal switch will activate, muting the signal.

When the amplifier has cooled down to a safe operating temperature, the thermal switch resets itself, and the ThumpSub GO subwoofer resumes normal operation.

If the thermal switch activates, try turning down the level control a notch or two on the mixing console to avoid overheating the amplifier. Be aware that direct sunlight and/or hot stage lights may be the culprit of an amplifier overheating.

AC Power

If using AC power (and not batteries), be sure the ThumpSub GO subwoofer is plugged into an outlet that is able to supply the correct voltage. It will continue to operate at lower voltages, but will not reach full power. Be sure the electrical service can supply enough amperage for all the components connected to it.

We recommend that a stiff (robust) supply of AC power be used because the amplifiers place high current demands on the AC line. The more power that is available on the line, the louder the subwoofer will play and the more peak output power will be available for a cleaner, punchier bass. A suspected problem of “poor bass performance” is often caused by a weak AC supply to the amplifiers.



Never remove the ground pin on the power cord or any other component of the ThumpSub GO subwoofer. This is very dangerous.

Care and Maintenance

Your ThumpSub GO subwoofer will provide many years of reliable service if you follow these guidelines:

- Avoid exposing it to moisture. If it is set up outdoors, be sure it is under cover if rain is expected.
- Avoid exposure to extreme cold (below freezing temperatures). If you must operate in a cold environment, warm up the voice coils slowly by sending a low-level signal through them for about 15 minutes prior to high-power operation.
- Use a dry cloth to clean the cabinet. Only do this when the power is turned off. Avoid getting moisture into any of the openings of the cabinet, particularly where the drivers are located.

Hookup Diagrams

Hookup Diagrams > Small Club System

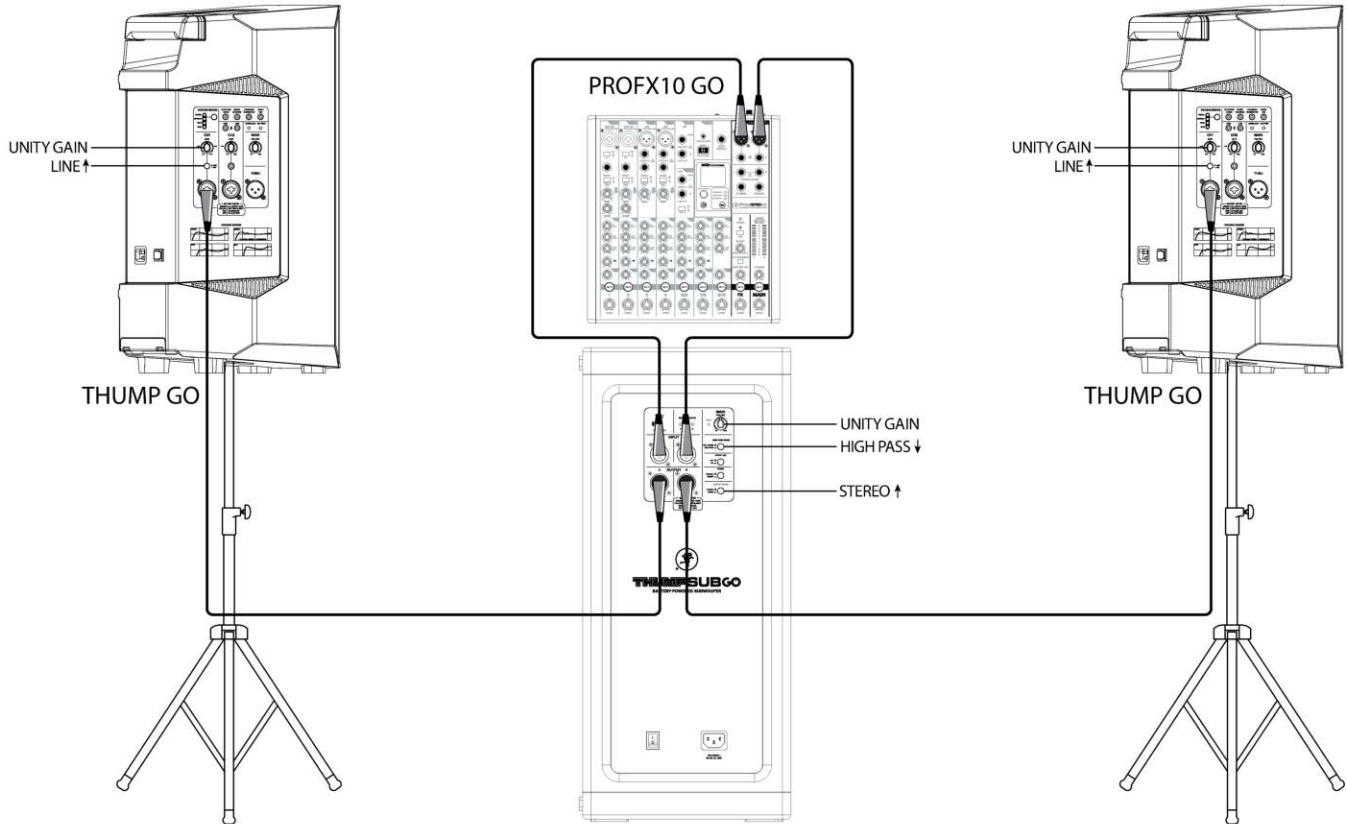

The Small Club System example is the perfect setup for a small club or... a totally happenin' karaoke house party! Here, a ProFX10 GO mixer is connected directly to a ThumpSub GO subwoofer which, in turn, is connected to a pair of Thump GO loudspeakers.

Simply connect the L/R outputs of a ProFX10 GO mixer directly to the Ch. A and B inputs of the ThumpSub GO subwoofer. Then the output jacks of the subwoofer are connected to the channel 1 inputs on a pair of Thump GO loudspeakers.

Here you will want to set the subwoofer's High Pass Mode to High Pass (switch down). The gain knobs on the subwoofer and both loudspeakers should be set to unity gain (12:00 noon, pointing straight up). Additionally, the Mic/Line switches should be disengaged [Line]. Keep in mind that these "U" (for unity) markings are for reference only and may need to be raised or lowered.

What's more? All products in this diagram may be run on electricity or battery. So go ahead and camp with a full PA without having to worry about whether there will be electricity nearby... or at all!

Hookup Diagrams > Large Club System

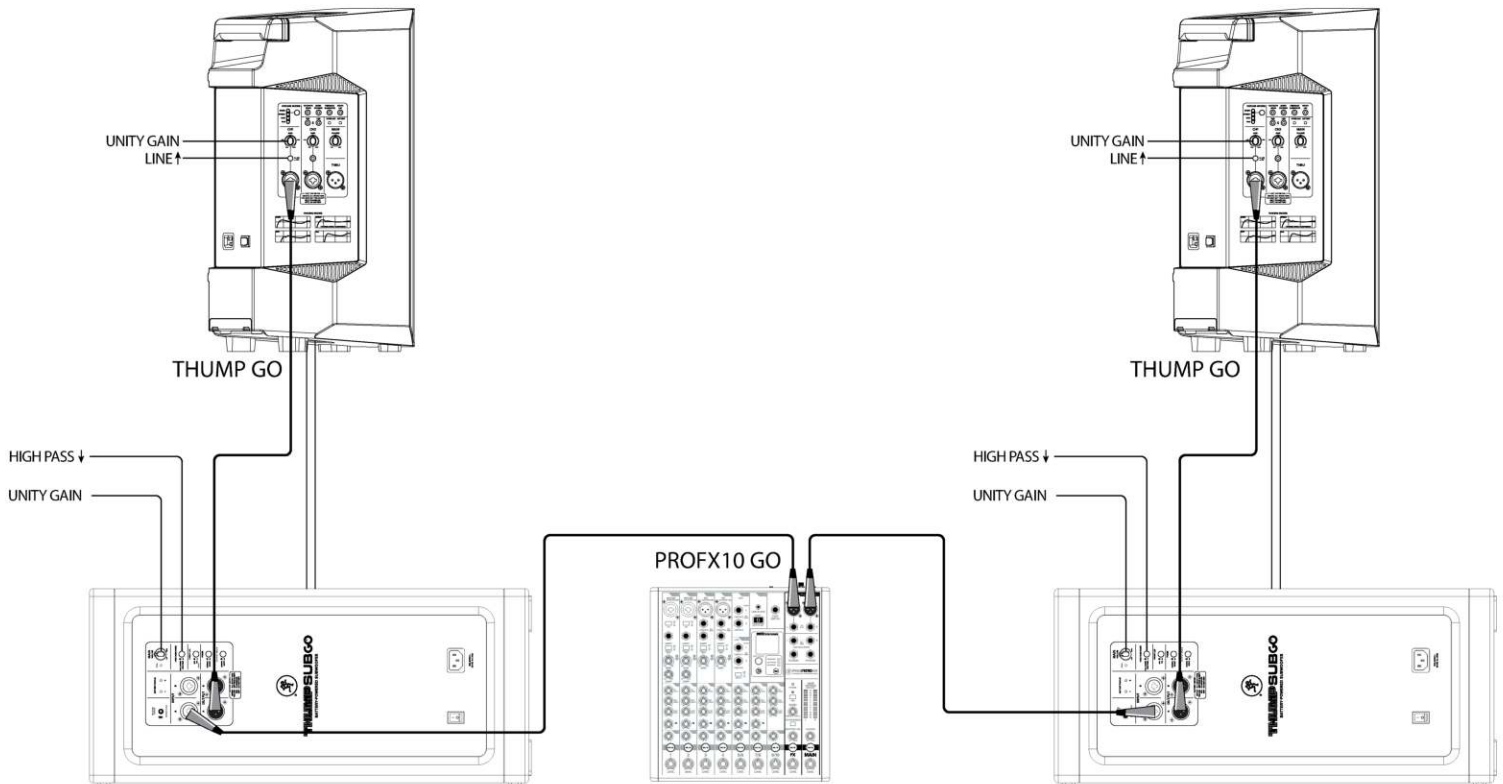

Perhaps the Small Club System didn't have enough beef to it. Alright, ok, we got you. Let's add another ThumpSub GO subwoofer to the mix. Welcome to the Large Club System! Here, a ProFX10 GO mixer is connected directly to two ThumpSub GO subwoofers which, in turn, are connected to a pair of Thump GO loudspeakers.

Simply connect the L/R outputs of a ProFX10 GO mixer directly to the Ch. A input of each ThumpSub GO subwoofer. Then the Ch. A output jack of each subwoofer is connected to the channel 1 input on each Thump GO loudspeaker.

Here you will want to set the subwoofer's High Pass Mode to High Pass (switch down). The gain knobs on both subwoofers and loudspeakers should be set to unity gain (12:00 noon, pointing straight up). Additionally, the Mic/Line switches should be disengaged [Line]. Keep in mind that these "U" (for unity) markings are for reference only and may need to be raised or lowered.

What's more? All products in this diagram may be run on electricity or battery. So go ahead and camp with a full PA without having to worry about whether there will be electricity nearby... or at all!

Hookup Diagrams > DJ System

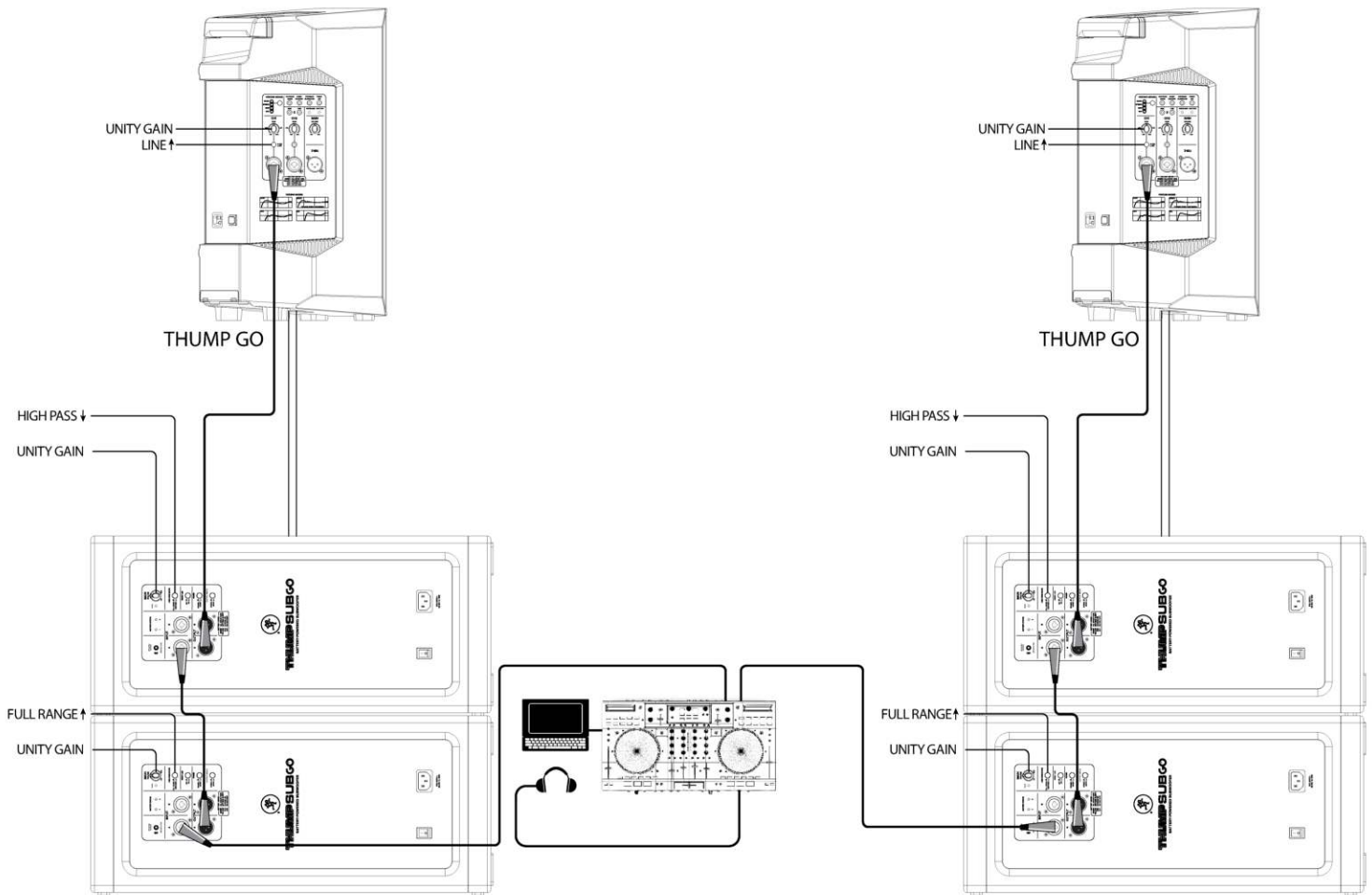

Want even more low end? You're in luck! Let's add another TWO ThumpSub GO subwoofers to the mix. Welcome to the DJ System! Visualize that you're a DJ playing bumpin' tunes in the middle of the night to a crowd that's groovin' and dancin' to your fine selection.

Here, a laptop is connected to a DJ controller. A set of Mackie MC-350 headphones is connected to the phones jack of the DJ controller.

The L/R outputs of the DJ controller are then connected to the Ch. A inputs of two ThumpSub GO subwoofers. The Ch. A output of each bottom ThumpSub GO subwoofer is then connected to the Ch. A input of each ThumpSub GO subwoofer above it. Then the Ch. A output jack of each subwoofer is connected to the channel 1 input on each Thump GO loudspeaker.

IMPORTANT – BOTTOM ThumpSub GO subwoofers: Confirm that the High Pass Mode switch is disengaged (up, Full Range) since we're connecting to additional ThumpSub GO subwoofers, not loudspeakers (which would be High Pass, switch engaged).

IMPORTANT – TOP ThumpSub GO subwoofers: Confirm that the High Pass Mode switch is engaged (down, High Pass) since we're connecting to loudspeakers, not additional ThumpSub GO subwoofers (which would be Full Range, switch disengaged).

The gain knobs on the subwoofers and loudspeakers should be set to unity gain (12:00 noon, pointing straight up). Additionally, the Mic/Line switches should be disengaged [Line]. Keep in mind that these "U" (for unity) markings are for reference only and may need to be raised or lowered.

Hookup Diagrams > Daisy-Chaining Multiple ThumpSub GO Subwoofers

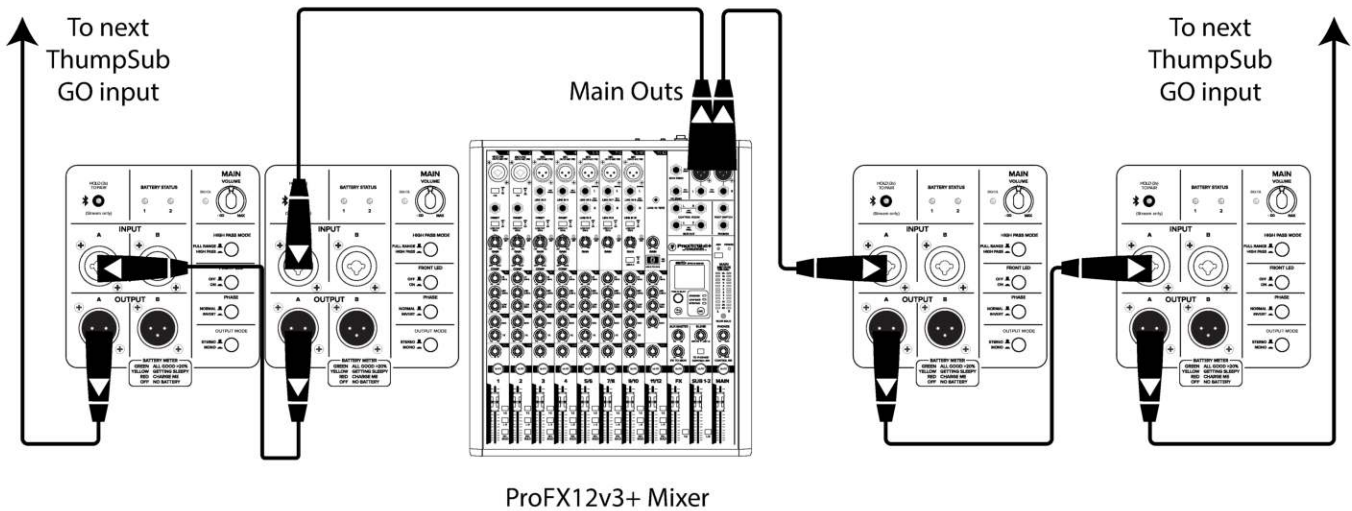

ThumpSub GO subwoofers may be daisy-chained via the output jack which outputs all inputs. Simply plug the signal source (i.e., mixer output) into the input jack(s), and patch that subwoofer's output jack to the next subwoofer's input jack, and so on, daisy-chaining multiple ThumpSub GO subwoofers. See above for visual representations of daisy-chaining.

NOTE: Confirm that the High Pass Mode switch is disengaged (up, Full Range) since we're connecting to additional ThumpSub GO subwoofers, not loudspeakers (which would be High Pass, switch engaged). Also of note, the main volume knob is set at unity (12:00). This is for reference only and may need to be raised or lowered.

Appendix A: Service Information

Introduction

If you think your ThumpSub GO subwoofer has a problem, please check out the following troubleshooting tips and do your best to confirm the problem. Visit the Support section of our website (www.mackie.com/support) where you will find lots of useful information such as FAQs and other documentation. You may find the answer to the problem without having to part with your subwoofer.

Here are some useful tips that could correct any of the issues outlined below (or possibly any other issue that we haven't yet discovered):

Getting Started: If you are having any sound (or non-sound) issues, try following the level setting procedure as outlined on page 6 to verify that all of the volume controls in the system are properly adjusted.

There are no user serviceable parts. If none of these tips work, please refer to "Repair" on the next page to find out how to proceed.

Troubleshooting

No power

- Our favorite question. Is it plugged in (whether by power cord or battery)?
- Our favorite follow-up question. If using a battery, is it fully charged? Are you sure?
- Another favorite. Is the rear panel power switch in the ON position? If not, try turning it on.
- Make sure the line cord is securely seated in the line cord socket and plugged all the way into the AC outlet.
- Is the power LED on the front panel illuminated? If not, make sure the AC outlet is live. If so, refer to "No sound" below.
- Are all the lights out in town? If so, contact the local power company to get power restored.
- The internal AC line fuse may be blown. This is not a user serviceable part. If you suspect the AC line fuse is blown, please see the "Repair" section on the following page.

No sound

- Is the level knob for the input source turned all the way down? Verify that all the volume controls in the system are properly adjusted. Look at the level meter to ensure that the mixer is receiving a signal.
- Is the signal source working? Make sure the connecting cables are in good repair and securely connected at both ends. Make sure the output level control on the mixing console is turned up sufficiently to drive the inputs of the speaker.
- Make sure the mixer does not have a mute on or a processor loop engaged. If you find something like this, make sure the level is turned down before disengaging the offending switch.
- Has it shut down? Make sure there is at least six inches of free space behind each ThumpSub GO subwoofer.

Poor sound

- Is it loud and distorted? Make sure that you're not overdriving a stage in the signal chain. Verify that all level controls are set properly.
- Is the input connector plugged completely into the jack? Be sure all connections are secure.

Poor bass performance

- Check the polarity of the connections between the mixer and the subwoofers. You may have your positive and negative connections reversed at one end of one cable, causing one subwoofer to be out-of-phase with the other.
- Poor bass performance may be the result of bad AC power. See the section titled 'AC Power' on page 16 for further details.

Noise

- Make sure all connections to the subwoofers and loudspeakers are good and sound.
- Make sure none of the signal cables are routed near AC cables, power transformers, or other EMI-inducing devices.
- Is there a light dimmer or other SCR-based device on the same AC circuit as the ThumpSub GO subwoofer? Use an AC line filter or plug the subwoofer into a different AC circuit.

Hum

- Try disconnecting the cable connected to the input jack. If the noise disappears, it could be a "ground loop," rather than a problem with the ThumpSub GO subwoofer. Try some of the following troubleshooting ideas:
 - Use balanced connections throughout your system for the best noise rejection.
 - Whenever possible, plug all the audio equipment's line cords into outlets which share a common ground. The distance between the outlets and the common ground should be as short as possible.

Other Issues

- Please submit a support ticket if you are having any other issue not listed here:
 - o mackie.com/support-contact

Repair

For warranty service, refer to the warranty information on page 28.

Non-warranty service is available at a factory-authorized service center. To locate the nearest service center, visit www.mackie.com/en/support/service-center-locator. Service for ThumpSub GO subwoofers living outside the United States may be obtained through local dealers or distributors.

Appendix B : Technical Information

ThumpSub GO Specifications

Acoustic Performance

Frequency Response (-10 dB): 32 Hz – 152 Hz
 Frequency Response (-3 dB): 39 Hz – 100 Hz
 Maximum SPL Peak: 123 dB

Transducers

Low Frequency: 2x 8 in / 203 mm custom woofer

Power Amplifiers

System Power Amplification

Rated Power: 400 watts peak

Low Frequency Power Amplifier

Rated Power: 400 watts peak
 Rated THD: <1%
 Cooling: Convection
 Design: Class D

Input / Output

Input Type 2x Female XLR – 1/4" balanced TRS combo jack and Bluetooth 5.4
 Mic/Line Impedance 600 Ω Balanced
 Output 2x Male XLR Balanced
 High Pass Mode Full Range, High Pass
 Output Mode Stereo / Mono
 Phase Normal / Invert
 Output Impedance 1 MΩ

Bluetooth Information

Bluetooth Protocol 5.4
 Bluetooth Function Audio streaming

Physical Properties (Product)

Height:	22.0 in // 559 mm
Width:	9.8 in // 249 mm
Depth:	21.0 in // 533 mm
Weight:	40.0 lb // 18.1 kg (no battery) 41.7 lb // 18.9 kg (one battery)

Physical Properties (Packaged Product)

Height:	26.8 in // 681 mm
Width:	13.0 in // 330 mm
Depth:	24.5 in // 622 mm
Weight:	44.4 lb // 20.1 kg

Ordering Information

ThumpSub GO – BATTERY-POWERED PORTABLE SUBWOOFER

US	2057855-00 (US)
EU	2057855-01 (EU)
JP	2057855-02 (JP)
UK	2057855-03 (UK)
AU	2057855-04 (AU)
CN	2057855-05 (CN)
BZ ~120V	2057855-06 (BZ ~120V)
AR	2057855-07 (AR)
KR	2057855-08 (KR)
IN	2057855-09 (IN)

About

Part Number, Rev and Date:.....SW1490, Rev C, December 2025

LOUD Audio, LLC. is always striving to improve our products by incorporating new and improved materials, components, and manufacturing methods. Therefore, we reserve the right to change these specifications at any time without notice. The "Running Man" is a registered trademark of LOUD Audio, LLC. All other brand names mentioned are trademarks or registered trademarks of their respective holders, and are hereby acknowledged.

Please check our website for any updates to this Owner's Manual: www.mackie.com.
©2025 LOUD Audio, LLC. All right All right All rights reserved.

ThumpSub GO Dimensions

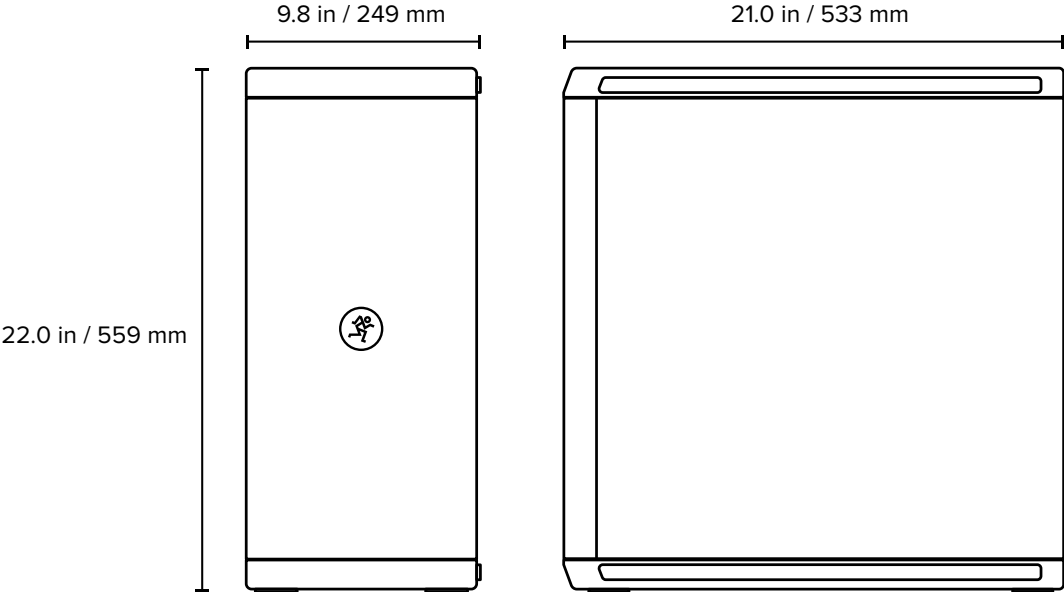

ThumpSub GO Block Diagram

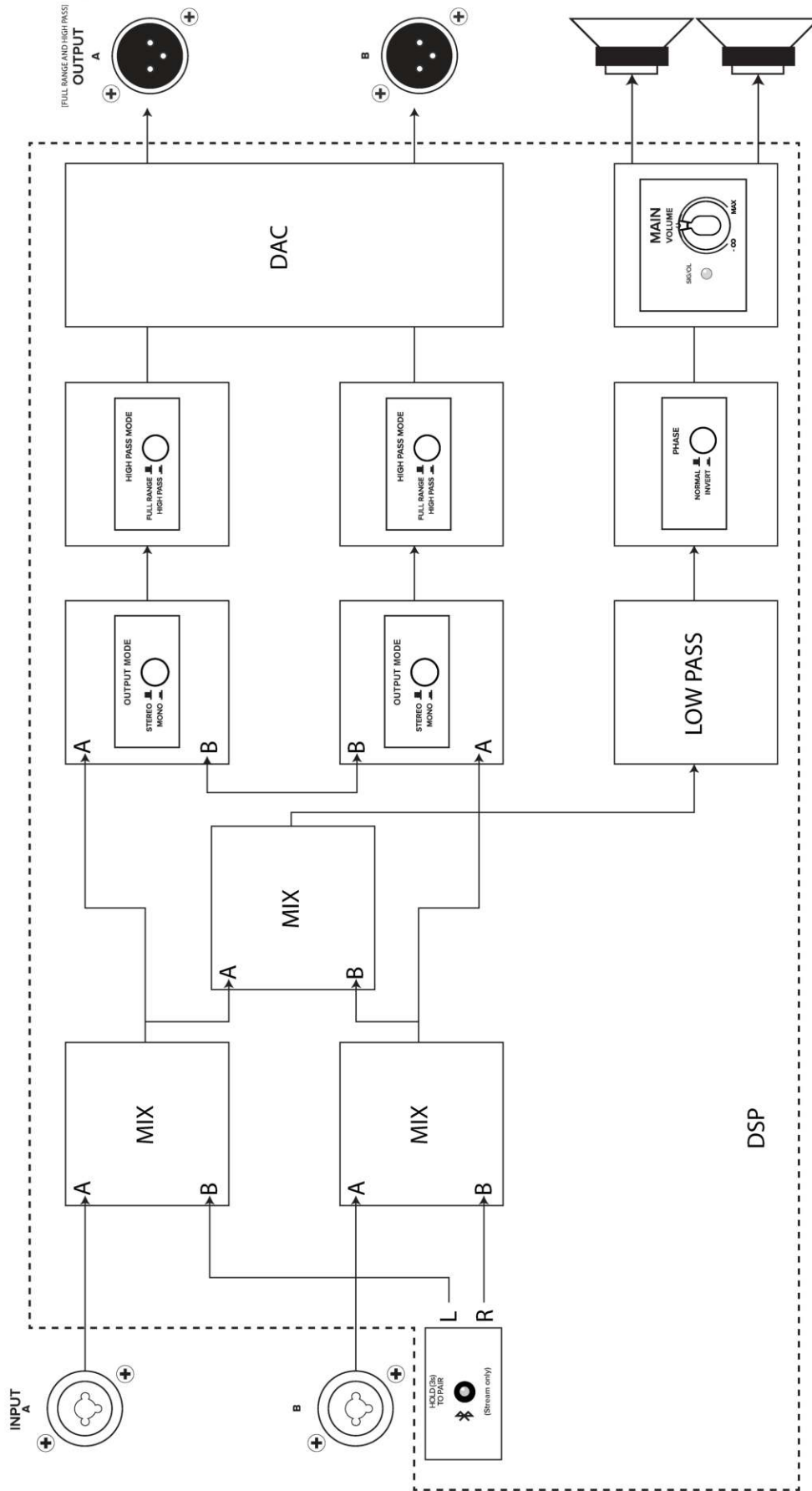

Warranty Statement

Please keep your sales receipt in a safe place.

This Limited Product Warranty ("Product Warranty") is provided by LOUD Audio, LLC. ("LOUD") and is applicable to products purchased in the United States or Canada through a LOUD-authorized reseller or dealer. The Product Warranty will not extend to anyone other than the original purchaser of the product (hereinafter, "Customer," "you" or "your").

For products purchased outside the U.S. or Canada, please visit www.mackie.com/warranty to find contact information for your local distributor, and information on any warranty coverage provided by the distributor in your local market.

LOUD warrants to Customer that the product will be free from defects in materials and workmanship under normal use during the Warranty Period. If the product fails to conform to the warranty then LOUD or its authorized service representative will at its option, either repair or replace any such nonconforming product, provided that Customer gives notice of the noncompliance within the Warranty Period to the Company at: www.mackie.com/support or by calling LOUD technical support at 1.800.898.3211 (toll-free in the U.S. and Canada) during normal business hours Pacific Time, excluding weekends or LOUD holidays. Please retain the original dated sales receipt as evidence of the date of purchase. You will need it to obtain any warranty service.

For full terms and conditions, as well as the specific duration of the Warranty for this product, please visit www.mackie.com/warranty.

The Product Warranty, together with your invoice or receipt, and the terms and conditions located at www.mackie.com/warranty constitutes the entire agreement, and supersedes any and all prior agreements between LOUD and Customer related to the subject matter hereof. No amendment, modification or waiver of any of the provisions of this Product Warranty will be valid unless set forth in a written instrument signed by the party to be bound thereby.

Need help with the ThumpSub GO subwoofer?

- Visit www.mackie.com/support to find: FAQs, manuals, addendums, and other documents.
- Email us at: www.mackie.com/support-contact

**Please write the serial numbers here for future reference
(i.e., insurance claims, tech support, return authorization, make dad proud, etc.)**

Purchased at:

Date of purchase:



19820 North Creek Parkway #201, Bothell, WA 98011 • USA
www.mackie.com

