

Ibanez

INSTRUCTION MANUAL

Maintenance

ATTACHMENTS

	Multi-tool	Tremolo arm	HEX key wrench					8mm socket wrench
			1.5mm	2mm	2.5mm	3mm	4mm	
PREMIUM series Edge tremolo bridge	○	○						
PREMIUM series Edge-Zero II w/ZPS	○	○						
PREMIUM series ZR tremolo bridge w/ZPS2	○	○						
PREMIUM series Tight-End R bridge	○							
Edge III tremolo bridge		○		○	○	○	○	
Edge-Zero II w/ ZPS		○		○		○	○	
Edge-Zero II w/o ZPS		○		○		○	○	
FAT6 tremolo bridge		○	○			○	○	
FAT10 tremolo bridge		○	○			○	○	
FX Edge III bridge					○	○	○	
FX Edge III-8 bridge					○	○	○	
Gibraltar Standard 6/7/8 bridge			○		○		○	
SAT10 tremolo bridge		○	○			○	○	
SAT-Pro II tremolo bridge		○	○			○	○	
STD tremolo bridge		○						
STD-DL tremolo bridge		○						
Tight-End bridge				○			○	
Tight-Tune bridge				○		○	○	
ZR tremolo bridge w/ZPS2		○		○		○	○	
SynchroniZR tremolo bridge	○	○						
GIBRALTAR BRIDGE 08 / QUICK CHANGE 08 TAILPIECE								○

ENGLISH

- ※ Models equipped with DiMarzio pickups are shipped with an HEX key wrench for adjusting the height of the pole pieces.
- ※ Seven-string guitars equipped with an Edge-Zero II tremolo bridge w/ZPS3Fe are supplied with heavy-duty springs.

GUITAR PART IDENTIFICATION

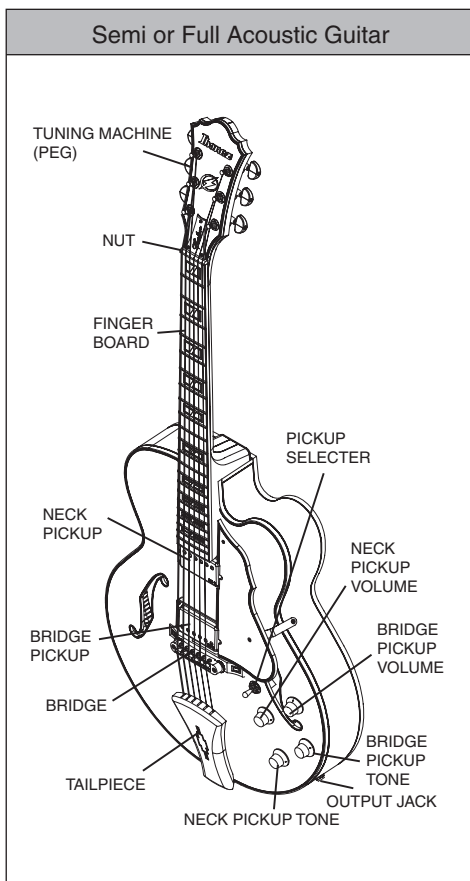
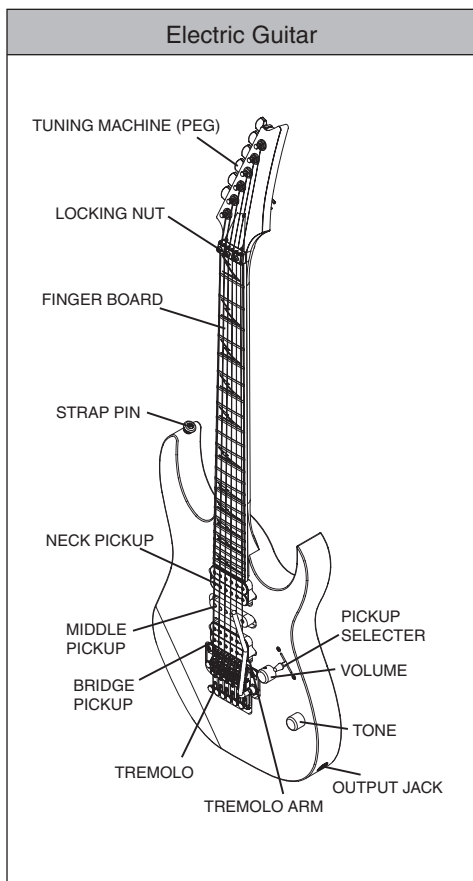

※ These illustrations show typical Ibanez models. The guitar you purchased might not match the illustration.

※ Tremolo/bridge adjustments will differ depending on the type of tremolo/bridge that is installed.
For details, refer to the applicable tremolo/bridge section.

※ For details on the controls of each model, refer to the "Controls" section (p.228).

TUNING

When shipped from the factory, Ibanez guitars are set up using the following tunings.

	1st	2nd	3rd	4th	5th	6th	7th	8th
6-strings	E4	B3	G3	D3	A2	E2	-	-
7-strings	E4	B3	G3	D3	A2	E2	B1	-
8-strings	D#4	A#3	F#3	C#3	G#2	D#2	D#2	F1

Note that following models are set up differently.

Baritone guitar

1st	2nd	3rd	4th	5th	6th	7th	8th
B	F#	D	A	E	B	-	-

RGD, APEX

	1st	2nd	3rd	4th	5th	6th	7th
6-strings	D4	A3	F3	C3	G2	D2	-
7-strings	D4	A3	F3	C3	G2	D2	A1

MTM100

1st	2nd	3rd	4th	5th	6th	7th	8th
C#	G#	E	B	F#	B	-	-

TAM10

1st	2nd	3rd	4th	5th	6th	7th	8th
E	B	G	D	A	E	B	E

Use a tuner or tuning fork to tune up the sound of each open string to the above frequencies. If the pitch is higher than the above frequency, loosen the string to lower the pitch, and wind the string in small increments to tune it up. This is an easy way to stabilize your tuning. You may need to adjust the neck or the intonation if you tune your guitar to pitches other than those shown in these tables, or if you use strings of other than standard gauge.

For details on adjusting the neck or the intonation, refer to the sections "NECK ADJUSTMENT" (p. 38) or "INTONATION" (p. 38).

Memo

- Please note that extreme tuning or use of strings not intended for electric guitar may cause parts to break, and may cause unexpected injury.

STRING REPLACEMENT

Strings will deteriorate over time, causing buzzing or inaccurate pitch. Replace the strings whenever your strings begin to rust or become discolored. We recommend that you replace all of the strings as a set at the same time. Bent, twisted, or damaged strings will not produce the appropriate quality sound and therefore should not be used.

Wind the string around the tuning machine post two or three times from above, using about 5--7 cm of length and taking care that the string does not cross itself. The strings should be replaced one by one instead of removing all the strings at once. This is done to avoid stress on the neck and to reduce the risk of affecting tremolo balance.

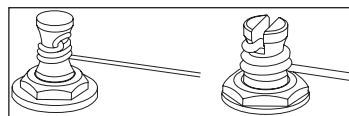

※The method for removing and installing strings attached to a tremolo/bridge will differ depending on the type of tremolo/bridge. For details, refer to the section for the tremolo/bridge installed on your guitar.

STRING HEIGHT

Action refers to the distance between the frets and the string.

To measure the action, tune the guitar accurately; then place a ruler at the 14th fret and measure the distance from the top of the fret to the bottom of the string. In general, this distance should be 1.5--1.7 mm for the first string, and 2.0 mm--2.2 mm for the sixth string.

For a seven-string guitar, the seventh string should be at 2.2 mm--2.4 mm. For an eight-string guitar, the eighth string should be at 2.4 mm--2.6 mm.

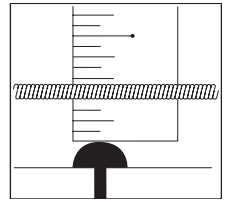

For strings other than those listed above, adjust the action so that the distance gradually increases from the first string toward the lowest string.

If the action is too high, the instrument will be difficult to play. If the action is too low, you may experience string buzz, muted notes, or poor sustain.

If you experience string buzz or muted notes even when the action is adjusted correctly, you might need to adjust the neck bow.

For details, refer to "Neck" (p. 38).

※ The method of adjusting the action will depend on the type of tremolo/bridge with which your guitar is equipped. For details, refer to the appropriate tremolo/bridge section.

INTONATION

If you've changed string gauges or are using your guitar with an alternative tuning, you'll need to adjust the string length (intonation) to ensure that the correct pitch is sounded at all frets.

After tuning your guitar accurately, hold the guitar in playing position and compare the pitch of each string pressed down at the 12th fret with the pitch of the harmonic played at the 12th fret.

If the pitch of the fretted note at the 12th fret is

lower than the harmonic at that fret, move the saddle of the tremolo/bridge forward to shorten the string.

Conversely, if the pitch of the fretted note is higher than the pitch of the harmonic, move the saddle backward to lengthen the string.

※ Use a tuning meter to ensure accurate intonation adjustments.

※ The method of adjusting the saddle position will differ depending on the installed model of tremolo/bridge. For details, refer to the section for the tremolo/bridge that's installed on your guitar.

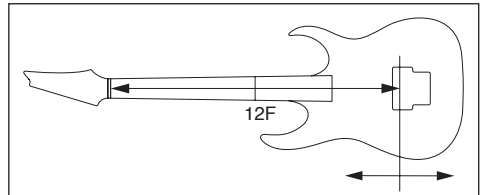

NECK ADJUSTMENT

The neck is constantly bearing the tension of the strings, and its curvature will be subtly affected not only by the state of tuning and the string gauge, but also by changes in temperature and humidity.

If you experience problems such as string buzz or muted notes even after the action and tuning are adjusted correctly, you should check and adjust the curvature of the neck.

1 Check the curvature of the neck.

After tuning accurately, hold the guitar in playing position. Then press the first string at the first fret and also at the fret that is nearest to the point where the neck joins the body, and measure the gap between the string and fret at the eighth fret.

In the same way, measure this gap for the lowest string, and make adjustments so that the gaps are in the range of 0.3 mm--0.5 mm.

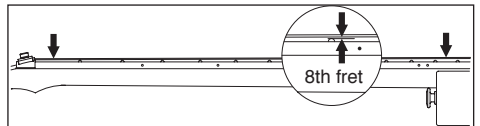

2 If the gap is less than 0.3 mm, use the HEX key wrench or socket wrench included with the guitar to turn the truss rod nut located at the headstock end of the neck in direction 'A', causing the neck curvature to be more convex.

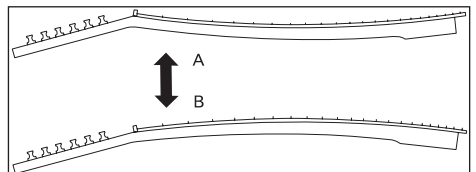

- 3 If the gap is greater than 0.5 mm, turn the HEX key wrench or socket wrench in direction 'B', causing the neck curvature to be more concave.
- ※ Adjust the truss rod nut in small increments of a quarter turn, checking the tuning while you do so.

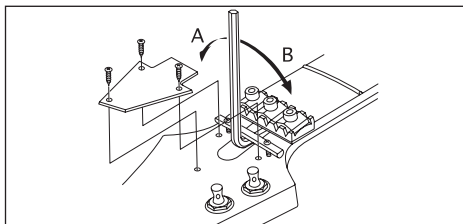

Memo

- You must take care when adjusting the neck.
- Forced adjustments can damage your guitar. If you are unable to adjust the neck correctly, please contact your Ibanez authorized dealer.

CLEANING

After playing, wipe sweat and oil off metal parts such as the underside of the strings, the frets, bridge saddles and nut. This will help to prevent rust. Dirt or dust that adheres to metal parts may adversely affect their function. Wipe off stubborn dirt with a soft cloth moistened with a small amount of oil.

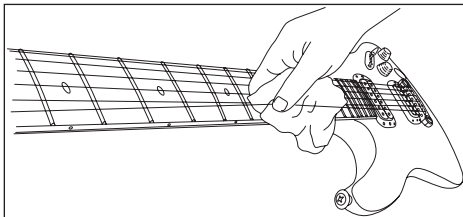

If the tremolo arm should squeak when turning, apply some grease to the notch on the shorter side of the tremolo arm.

To clean the finished surface, do not use volatile or abrasive cleaning compounds; instead gently wipe using a soft cloth with polish formulated specifically for musical instruments.

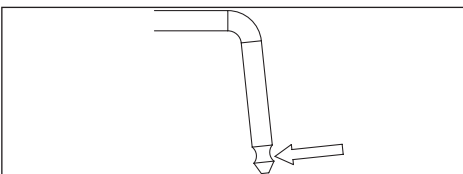

To clean off dirt that has adhered to an oil finished body or neck, use a pencil eraser, fine sandpaper of #1000 or finer grade, or #0000 steel wool. You can prevent drying by polishing once or twice a year with a colorless furniture finish oil or gun oil applied to #0000 steel wool or a cloth. Unfinished fingerboards should be carefully wiped with a cloth moistened with a small amount of fingerboard oil or high-quality lemon oil, wiping carefully to the edge of the frets.

BATTERY

If your guitar has a built-in pre-amplifier or equalizer, it will be powered by a battery. Replace the battery when you notice that the volume level has decreased or the sound has become distorted.

Some models use a 006P (9V) battery, and other models use two AA (1.5V) batteries.

Check the type of batteries used by your guitar, and replace them with the same type of batteries.

The batteries are found in the battery box located on the back of the body.

On models equipped with a battery, the output jack also functions as a power switch; inserting a plug into the jack will turn on the power.

Memo

- To prevent the battery from running down, remove the plug from the output jack if you will not be using it for an extended period.

Guitar Bridges

GIBRALTAR III (GUITAR & BASS), CB3, & FULL TUNE III, ART1, ART2

The action can be adjusted by using a slot head (-) screwdriver to turn the adjustment bolt at either end (A).

Intonation can be adjusted by moving the saddle forward or backward by turning the intonation adjustment screw (B) at the rear of the bridge. You can use either a Phillips (+), a flat head (-) screwdriver, or the optional hex wrench.

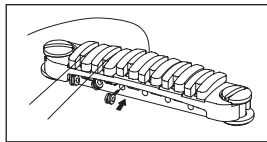
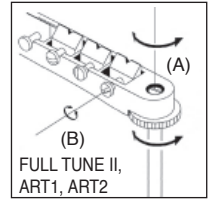
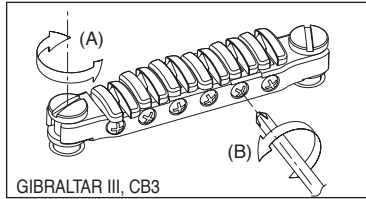

REPLACING THE STRINGS : CB3

Install strings by inserting them from the front of the bridge.

- ※ Before adjusting the action on the Gibraltar III bridge, loosen the strings sufficiently so that you will not need to turn the screws with excessive force, which could damage the screw holes.

HARDTAIL BRIDGE

To change strings, thread the new strings through the string grommets located on the back of the guitar and bring them up and over the saddle. The intonation can be adjusted by adjusting the saddle forward or backward using a Phillips (+) head screwdriver on the intonation adjustment screw at the rear of the bridge. String height is controlled by raising or lowering the small HEX key screws using a wrench on either side of the saddle.

- ※ The adjustment method is the same for 7-string and 8-string models.

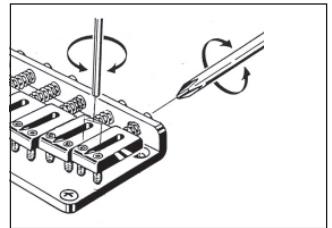

GIBRALTER STANDARD BRIDGE (7-STRING / 8-STRING MODELS)

To install a new string, pass it through the string stopper ferrule from the back of the guitar body.

To adjust the height of the strings, use a 1.5mm hexagonal wrench to turn and adjust the height of each saddle (A).

To adjust the intonation, use a 2.5mm hexagonal wrench to turn the intonation adjustment screws of each saddle on the back of the bridge (B).

- ※ The adjustment method is the same for 7-string and 8-string models.

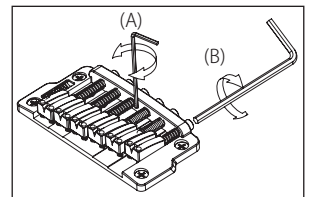

GIBRALTAR BRIDGE 08 / QUICK CHANGE 08 TAILPIECE

To adjust the string height, turn the stud bolts located at the left and right ends of the bridge (A) using a slotted (-) screw driver. Before adjustment, loosen the lock nut using an 8mm nut driver. After adjustment, tighten the lock nut again to x the bridge.

To adjust the tailpiece height, turn the adjustment screws (B) on both sides with a slotted (-) screw driver. Before adjustment, loosen the lock nut. After adjustment, x it again in the same way as the bridge. If the lock nut of the bridge and tailpiece is loose, it may cause distortion or resonance. Raising the tailpiece will reduce the string tension, which will provide a softer feel and make it easier to bend the strings.

To adjust the intonation of each saddle, turn the intonation adjustment screw using a slotted (-) screw driver (C).

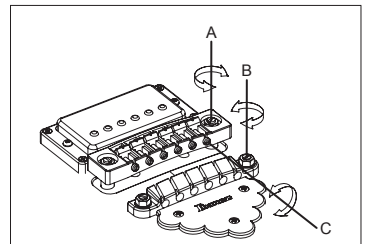

ADJUSTABLE ARCH TOP BRIDGE

To adjust the string height, adjust the height of the entire bridge by using your fingers to turn the thumb wheel screws (A) located at either side of the bridge. (It is not possible to individually adjust the height of each string.)

To adjust the intonation, loosen the strings and move the entire bridge forward or backward; then tune the guitar and check the intonation. Repeat this adjustment until the intonation is correct. Take care that the bridge does not fall over.

When replacing the strings, it is recommended that they be replaced one by one so that the bridge does not become displaced.

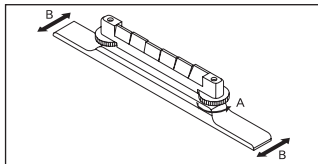

Vintage Vibrato

Replace the strings one by one. Fix the ball end onto the post of the bar (B), extend the string over the bar, and then wrap it around the peg. For a model with a retainer bar (A), VBX60/VBX80, pass the string over the bar and then beneath the retainer bar before wrapping it around the peg. While replacing strings, always pull the string lightly toward the headstock and exercise care not to allow the ball-end to go off the post. Check that the string is correctly placed on the saddle while tuning. After completing tuning, proceed to replacement of the next string. After finishing replacing all strings, carry out tuning again for the entire unit.

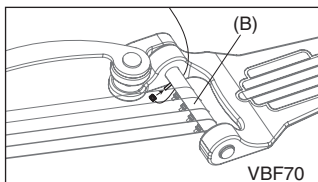
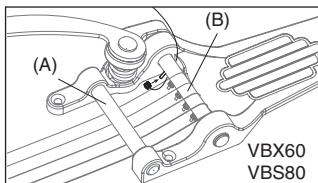

Memo

Removing all strings at the same time may have a serious impact on the state of each section of the guitar due to sudden changes of tension imposed on the guitar. Be sure to replace the strings one by one.

Tailpieces

QUIK CHANGE TAILPIECES

To adjust the height of the tailpiece, turn the stud bolt on the right and left ends of the tailpiece with a slot head screwdriver or a coin.

To install a new string, pass it through the slot of the tailpiece and hook the ball end into the back of the tailpiece.

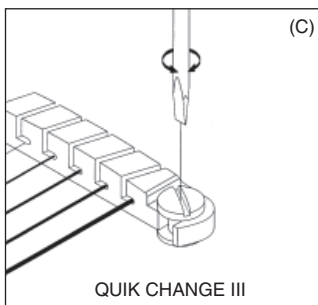

Tight-End bridge / Tight-End R bridge (for 6-string and 7-string)

■ Tight-End

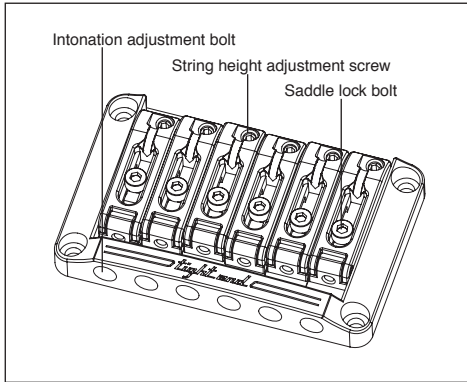

■ Tight-End

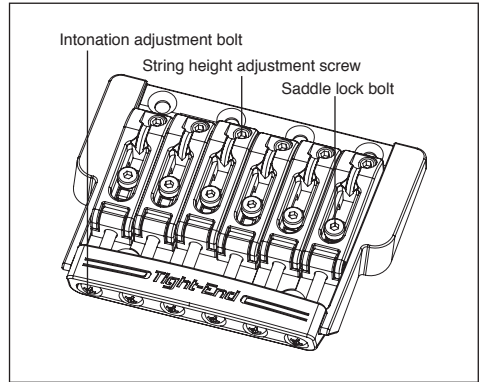

ADJUSTING THE ACTION

- 1 Use an HEX key wrench (2 mm) to loosen the saddle lock bolts.
 - 2 To adjust the saddle height, use the HEX key wrench (2 mm) to turn the saddle height adjustment screws.
- ※ When you've finished making adjustments, tighten the saddle lock bolts.

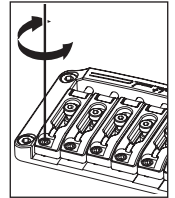
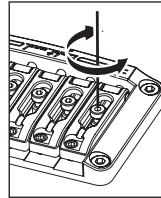

ADJUSTING THE INTONATION

- 1 Use an HEX key wrench (2 mm) to loosen the saddle lock bolts.
- 2 Use a Phillips screwdriver to adjust the saddle position by turning the intonation adjustment bolt.
- 3 Use an HEX key wrench (2 mm) to tighten the saddle lock bolts, and use a Phillips screwdriver to lightly tighten the intonation adjustment screw in the clockwise direction. (Tighten lightly, so as not to affect the saddle position.)

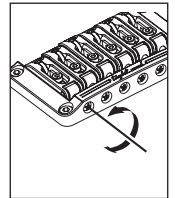
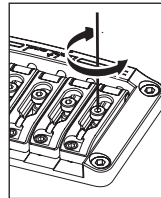

※ Make sure that the guitar is tuned correctly before you check the intonation.

STRING REPLACEMENT

To install a new string, pass it through the string stopper ferrule from the back of the guitar body.

TIGHT-TUNE BRIDGE

The Tight-Tune bridge achieves the optimum level of stability and sound transference while suppressing unnecessary vibrations by allowing each movable part of the bridge to be locked. The bridge has a stud lock function for fixing the bridge more securely onto the body. Furthermore, the tailpiece is equipped with a ball-end lock function to retain the ball end so that it will not come off.

ADJUSTING THE ACTION

Loosen the locking nuts (D) on the right and left sides of the bridge unit, and adjust the height of the bridge unit by turning the stud lock screws (E) with a 3 mm HEX key wrench. Note that it is not possible to adjust the height of individual strings. After completing the adjustment, tighten the locking nuts.

STUD LOCK FUNCTION

After adjusting the action, turn the stud lock bolt (B) clockwise inside the stud lock with a 2 mm HEX key wrench. Keep tightening until the stud lock bolt contacts the anchor bolt (C) and the bolt cannot be turned any further.

Memo

When adjusting the action, be sure to fully loosen the stud lock bolt (B) beforehand by turning it counterclockwise with a 2 mm HEX key wrench. Otherwise, damage may occur.

ADJUSTING THE INTONATION

Loosen the saddle lock screws (G) with a Phillips screwdriver, and turn the intonation adjustment screw (H) with a Phillips screwdriver to adjust the saddle position. Tune the guitar and check the intonation. Repeat these adjustments until the required intonation is reached, and then tighten the saddle lock screws.

Memo

A loose intonation adjustment screw (H) may cause resonance. If this occurs, gently tighten the intonation adjustment screw, exercising care not to allow the saddle to move.

REPLACING THE STRINGS

Insert the ball-end of the string into the slot of the tailpiece in the direction shown by arrow (J). The ball-end lock function retains the ball end. To remove the string, pull it toward direction (K).

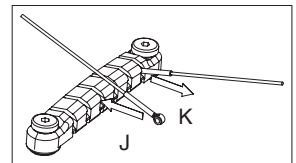
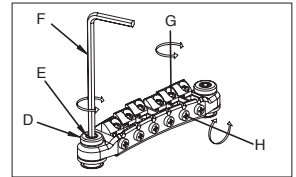
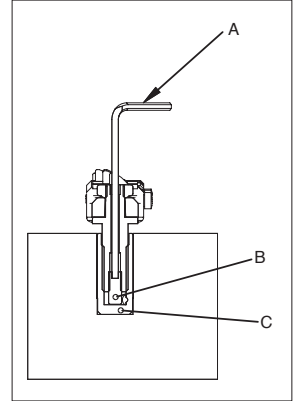

Locking Bridge

FX EDGE III/FX EDGE III-8 BRIDGE

■ FX Edge III

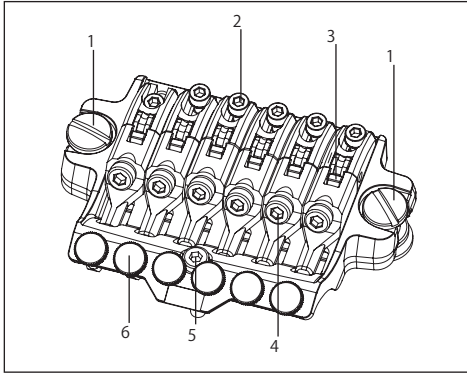

- 1 Main stud
- 2 Saddle lock bolt
- 3 String holder block
- 4 String stopper bolt
- 5 Rear stud
- 6 Fine tuning bolt

ADJUSTING THE ACTION

- 1 To adjust the string height, use a slotted screwdriver to turn the main studs at the left and right of the bridge unit to adjust the height of the entire tremolo unit. (It is not possible to adjust the height of individual strings.)
- 2 Use an HEX key wrench (3 mm) to turn the rear studs, adjusting them so that the bridge is approximately parallel with the surface of the guitar body.

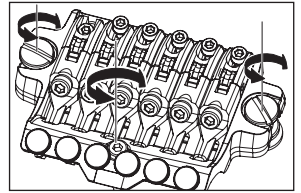

- ※ As the action will change when you adjust the rear studs, it is recommended that you check the final action after you've adjusted the rear studs.
To prevent the screw holes from being damaged, loosen the strings sufficiently before you adjust the main studs so that you will not have to use excessive force when turning the studs.

ADJUSTING THE INTONATION

- 1 Use an HEX key wrench (3 mm) to loosen the pressure pad bolts of the locking nut, and loosen the strings sufficiently.
 - 2 Use an HEX key wrench (2 mm) to loosen the saddle lock bolt, and adjust the saddle position.
- ※ Before checking the intonation, firmly tighten the saddle lock bolts and tune the guitar correctly. When you've finished making adjustments, tighten the saddle lock bolts and the pressure pad bolts of the locking nut.

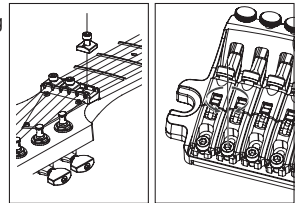

REPLACING THE STRINGS

- 1 Use an HEX key wrench (3 mm) to loosen the pressure pad bolts of the locking nut, and remove the string from the tuning peg.
- 2 Use an HEX key wrench (3 mm) to loosen the string stopper bolt of the bridge unit, then pull the string out of the saddle and remove it.
- 3 Use wire cutters to cut off the ball end of the new string.
- 4 Insert the tip of the string from which you cut off the ball end between the saddle and the string holder block, and tighten the string stopper bolt to fasten the string.
- 5 Wind the string onto the tuning peg, and tune it.
- 6 When you've finished tuning, tighten the pressure pad bolts of the locking nut.

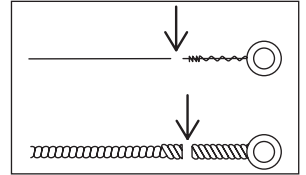
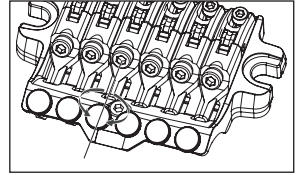

Memo

- Before you tune, make sure that the string stopper bolts are firmly tightened.

FINE TUNING

Even after you've used the locking nuts to lock the strings, you can use the fine tuners to fine-tune each string.

The range of adjustment after the strings are locked will be widest if you leave all fine-tuning bolts near the center of their adjustable range before you tune.

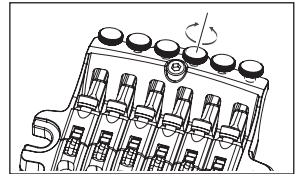

Locking Tremolos

EDGE TREMOLO BRIDGE

■ Edge

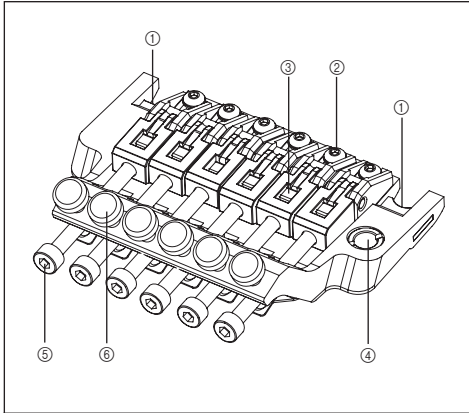

■ Lo-Pro Edge

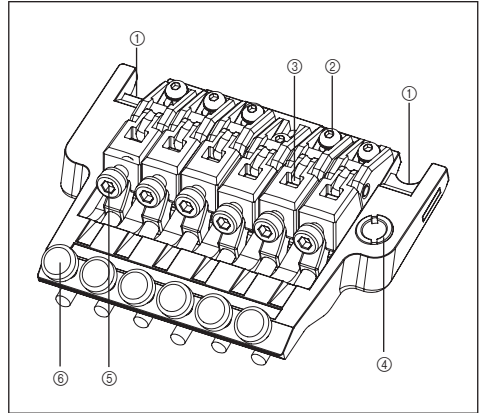

■ Rear

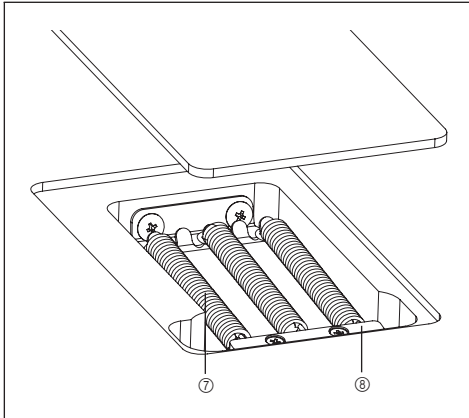

- ① Knife edge
- ② Saddle lock bolt
- ③ String holder block
- ④ Tremolo arm socket
- ⑤ String stopper bolt
- ⑥ Fine tuning bolt
- ⑦ Tremolo spring
- ⑧ Spring lock

ATTACHING THE TREMOLO ARM

- ① The tremolo arm employs a snap-in/snap-out design. Hold the corner of the tremolo arm, and press it into the arm socket of the base plate.

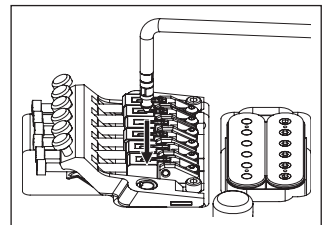

- ② The tightness of the tremolo arm attachment can be adjusted by adding or removing Teflon washers. Using a larger number of washers will make the attachment tighter, and removing all the washers will leave the arm free. The Teflon washers can be added or removed diagonally via the slit.

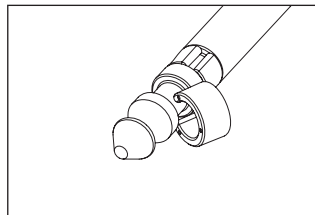

Memo

- If the arm is no longer held firmly in place even after you've added Teflon washers, replace the old Teflon washers with new ones.

ADJUSTING THE TREMOLO ATTACHMENT ANGLE

The tremolo attachment angle is adjusted by changing the balance between the string tension and the tension of the tremolo springs installed on the back of the guitar body. You'll obtain the optimal performance by adjusting this so that the tremolo is approximately horizontal to the surface of the guitar body.

- ① With the guitar tuned correctly, check the angle of the tremolo.
- ② If the tremolo is tilted toward the front, insert a Philips screwdriver through the slit in the tremolo spring cover on the back of the body, and tighten the screw to increase the tension of the tremolo springs.
- ③ If the tremolo is tilted toward the rear, loosen the screw to decrease the tension of the tremolo springs.

※ The tremolo angle adjustment will affect the tuning, because the balance of tension between the strings and the springs will change each time you adjust the tension of the tremolo springs. You'll need to tune repeatedly while making this adjustment.

TREMOLO SPRINGS

When the guitar is shipped from the factory, it is set up with three tremolo springs installed in parallel. If the balance of tension between the strings and the tremolo springs has changed significantly, such as when you've switched string gauges or are using a dropped tuning, you may need to change the number of tremolo springs or change the way in which they are installed.

- ① Use a Philips screwdriver to remove the spring lock.
- ② If you want to increase the tension, install the outer two tremolo springs diagonally.
- ③ If you want to decrease the tension, remove the center tremolo spring.

If you want to install four or more tremolo springs, attach them using the screw holes that were being used to attach the spring lock. (It will no longer be possible to attach the spring lock.)

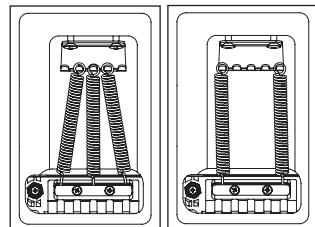
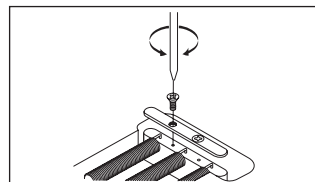
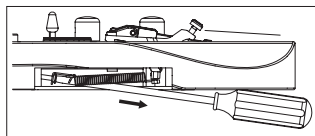
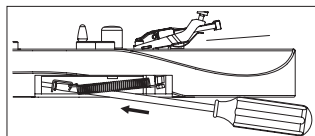

Memo

- Loosen the strings sufficiently before you install or remove tremolo springs. Be aware that if you remove all of the springs, the tremolo unit will detach from the guitar.
- To reattach the tremolo, insert the knife edge of the tremolo securely into the groove of the stud bolts, and then install the tremolo springs.

STUD LOCK

The Edge/Lo-Pro Edge tremolo bridge uses a stud lock mechanism.

- 1 Insert an HEX key wrench (1.5 mm) through the hole in the top of the stud bolt.
- 2 Turn the stud lock bolt clockwise, tightening it until it contacts the anchor nut and can no longer rotate.

※ The stud lock will be released when you loosen the stud lock bolt.

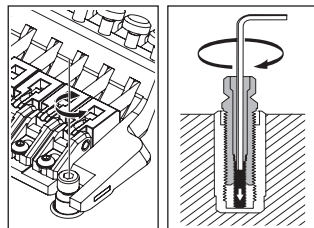

ADJUSTING THE ACTION

To adjust the height of the entire tremolo unit, use an HEX key wrench (4mm) to turn the stud bolts located at the left and right of the tremolo unit. (It is not possible to make adjustments for each string individually.)

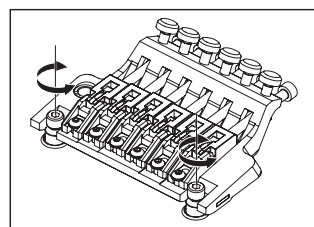

Memo

- Make sure that the stud lock is released before you adjust the action.

ADJUSTING THE INTONATION

- 1 Use an HEX key wrench (3 mm) to loosen the pressure pad bolts of the locking nut, and loosen the strings sufficiently.
- 2 Use an HEX key wrench (2 mm) to loosen the saddle lock bolts, and adjust the saddle position.

※ Before checking the intonation, firmly tighten the saddle lock bolts and tune the guitar correctly. When you've finished making adjustments, tighten the saddle lock bolts and the pressure pad bolts of the locking nut.

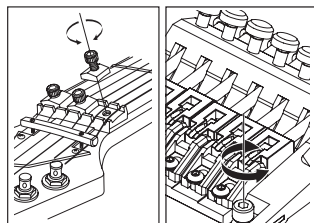

REPLACING THE STRINGS

- 1 Use an HEX key wrench (3 mm) to loosen the pressure pad bolts of the locking nut, and remove the string from the tuning peg.
- 2 Use an HEX key wrench (3 mm) to loosen the string stopper bolt of the tremolo unit; then pull the string out of the saddle and remove it.
- 3 Use wire cutters to cut off the ball end of the new string.
- 4 Insert the tip of the string from which you cut off the ball end between the saddle and the string holder block, and tighten the string stopper bolt to fasten the string.
- 5 Wind the string onto the tuning peg, and tune it.
- 6 When you've finished tuning, tighten the pressure pad bolts of the locking nut.

※ Removing all strings at the same time will cause the tremolo attachment angle to change significantly, so we recommend that you replace the strings one at a time. If you remove all strings at the same time, tuning will be easier if you wedge a piece of cloth below the tremolo to secure it so that the tremolo attachment angle won't change significantly.

Memo

- Before you tune, make sure that the string stopper bolts are firmly tightened.

FINE TUNING

Even after you've used the locking nuts to lock the strings, you can use the fine tuners to fine-tune each string. The range of adjustment after the strings are locked will be widest if you leave all fine-tuning bolts near the center of their adjustable range before you tune.

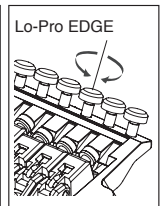
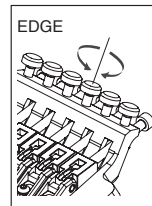
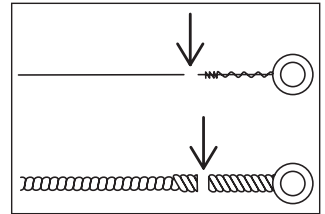
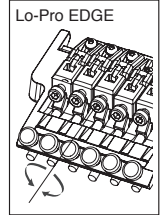
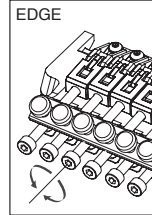
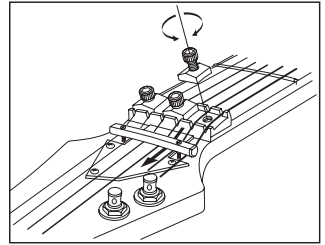

EDGE III TREMOLO BRIDGE

Overview

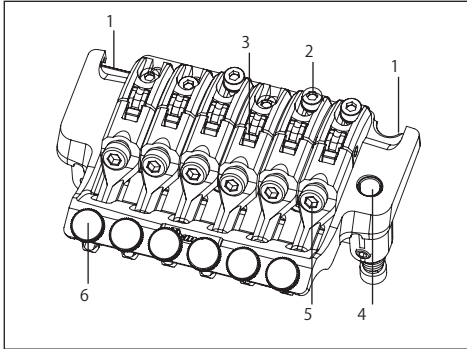

- 1 knife edge
- 2 saddle lock bolt
- 3 string holder block
- 4 tremolo arm socket

Rear

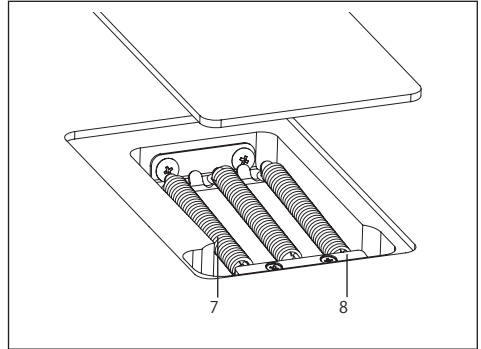

- 5 string stopper bolt
- 6 fine tuning bolt
- 7 tremolo spring
- 8 spring lock

ATTACHING THE TREMOLO ARM

- 1 The tremolo arm employs a snap-in/snap-out design. Hold the corner of the tremolo arm, and press it firmly into the arm socket of the base plate.
※The tremolo arm of the EDGE III Herman Li Ver. installed on the EGEN8 is a screw-in type.
After inserting the tremolo arm into the arm socket, rotate it to fasten it in place.
- 2 To adjust the tightness of the tremolo arm, use an HEX key wrench (2 mm) to adjust the torque adjustment screw via the adjustment hole on the side of the tremolo block. Tightening the torque adjustment screw clockwise will make the tremolo arm tighter; loosening the screw will make the arm looser.
- 3 To adjust the height of the tremolo arm, remove the tremolo spring cover on the back of the guitar and use an HEX key wrench (3 mm) to turn the height adjustment screws located on the bottom of the tremolo block. Tightening the screws clockwise will increase the height.

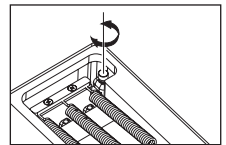
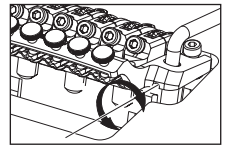
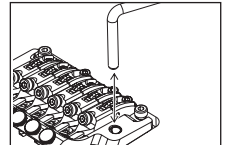

Memo

- In addition to the one described above, the tremolo arm also has a torque adjustment screw located at the bottom of the tremolo block.
The torque adjustment screw at the bottom of the tremolo block is already adjusted when the guitar is shipped from the factory; if it should require adjustment, remove the tremolo unit from the guitar and then adjust the screw.
- Before attaching the tremolo arm, make sure that the torque adjustment screw has not come loose or fallen out.

ADJUSTING THE TREMOLO ATTACHMENT ANGLE

The tremolo attachment angle is adjusted by changing the balance between the string tension and the tension of the tremolo springs installed on the back of the guitar body. You'll obtain the optimal performance by adjusting this so that the tremolo is approximately horizontal to the surface of the guitar body.

- 1 With the guitar tuned correctly, check the angle of the tremolo.
- 2 If the tremolo is tilted toward the front, insert a cross slot screwdriver through the slit in the tremolo spring cover on the back of the body, and tighten the screw to increase the tension of the tremolo springs.
- 3 If the tremolo is tilted toward the rear, loosen the screw to decrease the tension of the tremolo springs.

※ The tremolo angle adjustment will affect the tuning, because the balance of tension between the strings and the springs will change each time you adjust the tension of the tremolo springs. You'll need to tune repeatedly while making this adjustment.

TREMOLO SPRINGS

When the guitar is shipped from the factory, it is set up with three tremolo springs installed in parallel.

If the balance of tension between the strings and the tremolo springs has changed significantly, such as when you've switched string gauges or are using a dropped tuning, you may need to change the number of tremolo springs or change the way in which they are installed.

- 1 Use a cross slot screwdriver to remove the spring lock.
- 2 If you want to increase the tension, install the outer two tremolo springs diagonally.
- 3 If you want to decrease the tension, remove the center tremolo spring.

If you want to install four or more tremolo springs, attach them using the screw holes that were being used to attach the spring lock. (It will no longer be possible to attach the spring lock.)

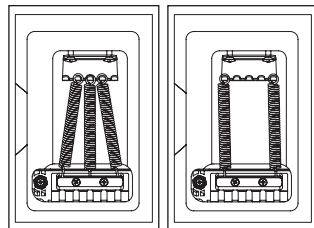
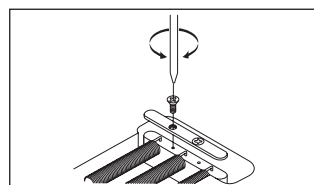
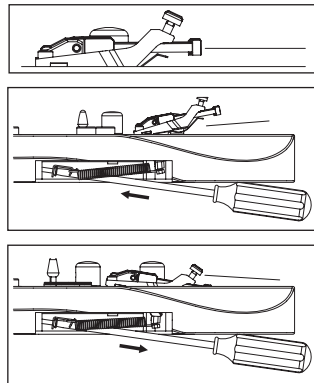

Memo

- Loosen the strings sufficiently before you install or remove tremolo springs. Be aware that if you remove all of the springs, the tremolo unit will detach from the guitar.
- To reattach the tremolo, insert the knife edge of the tremolo securely into the groove of the stud bolts, and then install the tremolo springs.

ADJUSTING THE ACTION

To adjust the height of the entire tremolo unit, use an HEX key wrench (3mm) to turn the stud bolts located at the left and right of the tremolo unit. (It is not possible to make adjustments for each string individually.)

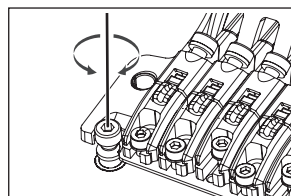

ADJUSTING THE INTONATION

- 1 Use an HEX key wrench (3 mm) to loosen the pressure pad bolts of the locking nut, and loosen the strings sufficiently.

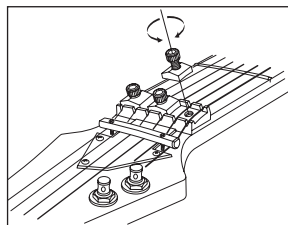

- 2 Use an HEX key wrench (2 mm) to loosen the saddle lock bolts, and adjust the saddle position.

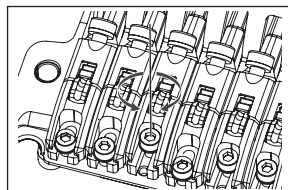

※ Before checking the intonation, firmly tighten the saddle lock bolts and tune the guitar correctly. When you've finished making adjustments, tighten the saddle lock bolts and the pressure pad bolts of the locking nut.

REPLACING THE STRINGS

- 1 Use an HEX key wrench (3 mm) to loosen the pressure pad bolts of the locking nut, and remove the string from the tuning peg.
- 2 Use an HEX key wrench (3 mm) to loosen the string stopper bolt of the tremolo unit; then pull the string out of the saddle and remove it.
- 3 Use wire cutters to cut off the ball end of the new string.

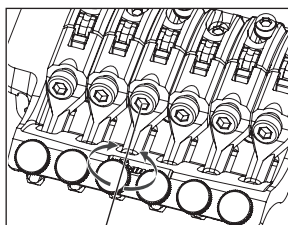

- 4 Insert the tip of the string from which you cut off the ball end between the saddle and the string holder block, and tighten the string stopper bolt to fasten the string.

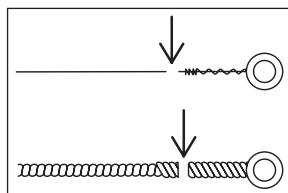

- 5 Wind the string onto the tuning peg, and tune it.

- 6 When you've finished tuning, tighten the pressure pad bolts of the locking nut.

※ Removing all strings at the same time will cause the tremolo attachment angle to change significantly, so we recommend that you replace the strings one at a time. If you remove all strings at the same time, tuning will be easier if you wedge a piece of cloth below the tremolo to secure it so that the tremolo attachment angle won't change significantly.

Memo

- Before you tune, make sure that the string stopper bolts are firmly tightened.

FINE TUNING

Even after you've used the locking nuts to lock the strings, you can use the fine tuners to fine-tune each string.

The range of adjustment after the strings are locked will be widest if you leave all fine-tuning bolts near the center of their adjustable range before you tune.

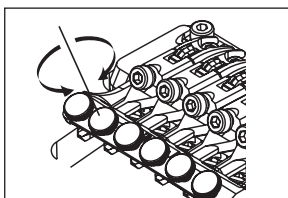

EDGE-ZERO2 TREMOLO BRIDGE

Overview

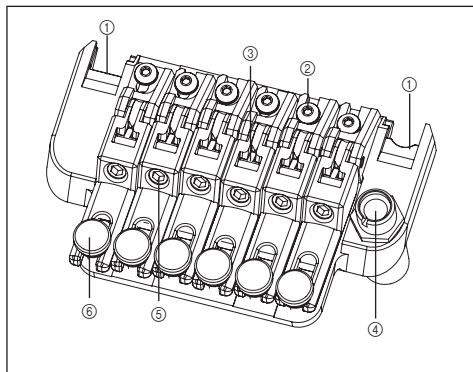

- ① knife edge
- ② saddle lock bolt
- ③ string holder block
- ④ tremolo arm socket
- ⑤ string stopper bolt
- ⑥ fine tuning bolt
- ⑦ main spring
- ⑧ sub spring
- ⑨ stopper
- ⑩ stop rod
- ⑪ tremolo block
- ⑫ spring adjustment knob
- ⑬ tremolo spring
- ⑭ spring lock

Rear 1

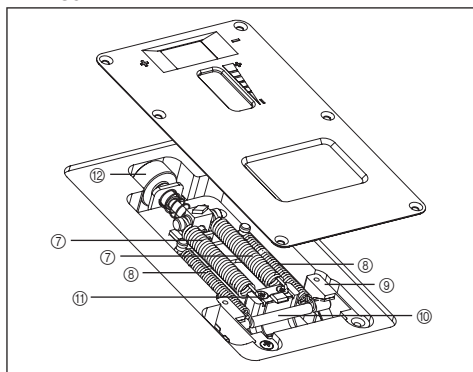

Rear 2

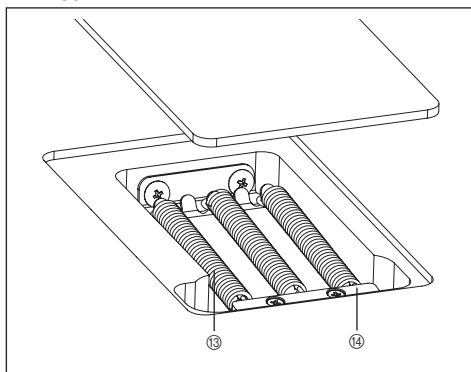

ATTACHING THE TREMOLO ARM

- ① The tremolo arm employs a one-piece snap-in design with an adjustable-torque cap. Insert the tremolo arm into the arm socket of the base plate.
- ② Tighten the torque adjustment cap to secure the tremolo arm. The tremolo arm will become tighter as you tighten the torque adjustment cap.

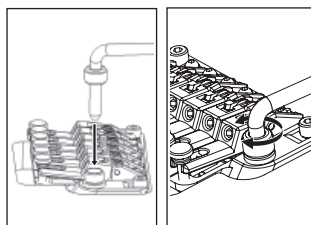

ANGLE ADJUSTMENT / ZERO POINT SYSTEM ADJUSTMENT

• Models not equipped with the zero point system

The tremolo attachment angle is adjusted by changing the balance between the string tension and the tension of the tremolo springs installed on the back of the guitar body. You'll obtain the best performance by adjusting the tremolo arm so that it is approximately parallel with the surface of the guitar body.

- ① With the guitar tuned correctly, check the angle of the tremolo.
- ② If the tremolo is tilted forward, insert a Philips screwdriver through the slit in the tremolo spring cover on the back of the body, and tighten the screws to increase the tension of the tremolo springs.
- ③ If the tremolo is tilted toward the rear, loosen the screws to weaken the tension of the tremolo springs.

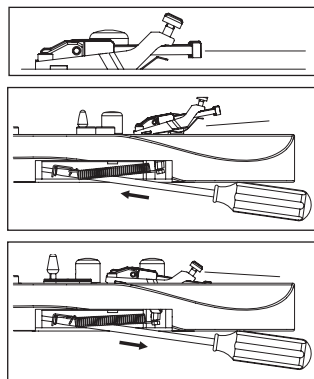

※ Because the balance of tension between the strings and the springs will change each time you adjust the tension of the tremolo springs, adjusting the tremolo angle will affect the tuning. You'll need to tune the guitar repeatedly while performing this adjustment.

• Models equipped with the zero point system

The angle at which the tremolo is attached is adjusted by the balance between the tension of the strings and the zero point system installed on the back of the guitar body. The Edge-Zero 2 tremolo bridge is designed so that when the zero point system is correctly adjusted, the tremolo will be approximately parallel with the surface of the guitar body, and will perform optimally when in that state.

When the zero point system is correctly adjusted, the stop rod will be in firm contact with the tremolo block and the stop rod will be touching the stopper.

- ① With the guitar tuned correctly, check the zero point system.
- ② If the stop rod is not touching the stopper (i.e., if the tremolo block is pushing up the stop rod), turn the spring adjustment knob located on the back of the body toward the "plus" direction to tighten the main spring.
- ③ If the tremolo block is not in firm contact with the stop rod (i.e., if the tremolo is tilted toward the rear), turn the spring adjustment knob toward the "minus" direction to loosen the main spring.

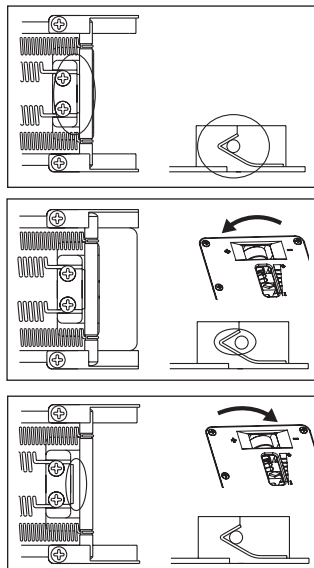

TREMOLO SPRING / ZERO POINT SYSTEM

• Models not equipped with the zero point system

When shipped from the factory, the guitar is set up with three tremolo springs installed in parallel.

If the balance of tension between the strings and the tremolo springs has changed significantly, such as when you switch to a different gauge of strings or use a dropped tuning, you may need to change the number of tremolo springs or change the way in which they are installed.

- ① Use a Philips screwdriver to remove the spring lock.
- ② If you want to increase the tension, install the outer two tremolo springs diagonally.
- ③ If you want to decrease the tension, remove the center tremolo spring.

If you want to install four or more tremolo springs, attach them using the screw holes that were being used to attach the spring lock. (It will no longer be possible to attach the spring lock.)

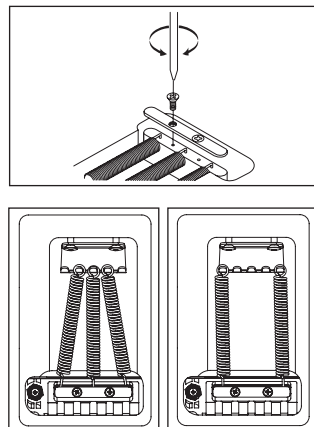

Memo

- Loosen the strings sufficiently before you install or remove tremolo springs.
Be aware that if you remove all of the springs, the tremolo unit will detach from the guitar.
- To reattach the tremolo, insert the knife edge of the tremolo securely into the groove of the stud bolts, and then install the tremolo springs.

• Models equipped with the zero point system

By disabling the zero point system you can use the unit as a conventional floating bridge.

When the zero point system is disabled, the angle at which the tremolo is attached will be adjusted by the balance between the tension of the strings and the tension of the main springs attached to the tremolo block.

For optimal performance, adjust the tremolo so that it is approximately parallel with the surface of the guitar body.

- 1 While holding the arm in the upward position (i.e., with the tremolo block away from the stop rod), remove the stop rod and the sub-spring.
 - 2 With the guitar tuned correctly, check the angle of the tremolo.
 - 3 If the tremolo is tilted toward the front, turn the spring adjustment knob toward the "plus" direction to tighten the main spring.
 - 4 If the tremolo is tilted toward the rear, turn the spring adjustment knob toward the "minus" direction to loosen the main spring.
- ※ The tuning will be affected when you adjust the tremolo angle with the zero point system disabled, because the balance between the tension of the strings and the springs will change each time you adjust the tension of the tremolo springs. You'll need to tune repeatedly while making this adjustment.

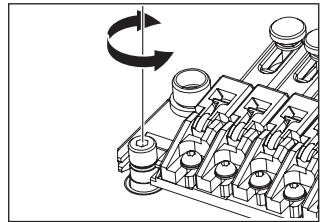
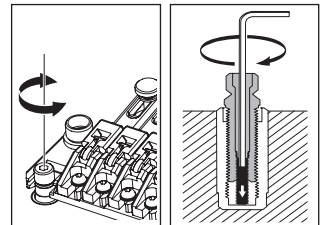
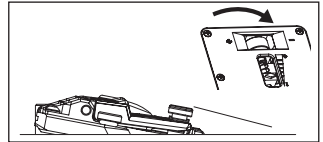
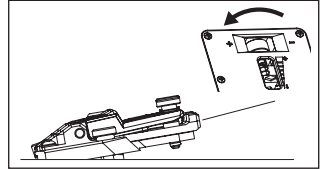
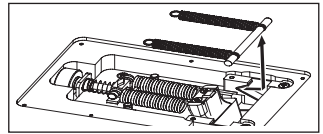

STUD LOCK

The Edge-Zero2 tremolo bridge uses a stud lock mechanism.

- 1 Insert a HEX key wrench (2mm) through the hole in the top of the stud bolt.
 - 2 Turn the stud lock bolt clockwise, tightening it until it contacts the anchor nut and can no longer rotate.
- ※ The stud lock will be released when you loosen the stud lock bolt.

ADJUSTING THE ACTION

To adjust the height of the entire tremolo unit, use an HEX key wrench (3 mm) to turn the stud bolts located at the left and right of the tremolo unit. (It is not possible to make adjustments for each string individually.)

Memo

- Before you tune, make sure that the string stopper bolts are firmly tightened.

ADJUSTING THE INTONATION

- 1 Use an HEX key wrench (3 mm) to loosen the pressure pad bolts of the locking nut, and loosen the strings sufficiently.
- 2 Use an HEX key wrench (2 mm) to loosen the saddle lock bolts, and adjust the saddle position.

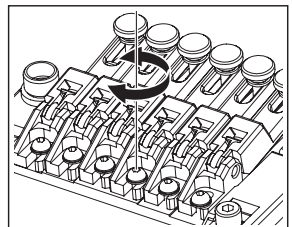
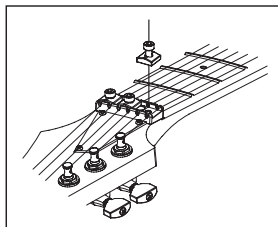

※ Before checking the intonation, firmly tighten the saddle lock bolts and tune the guitar correctly. When you've finished making adjustments, tighten the saddle lock bolts and the pressure pad bolts of the locking nut.

REPLACING THE STRINGS

- 1 Use an HEX key wrench (3 mm) to loosen the pressure pad bolts of the locking nut, and remove the string from the tuning peg.
- 2 Use an HEX key wrench (3 mm) to loosen the string stopper bolt of the tremolo unit; then pull the string out of the saddle and remove it.
- 3 Use wire cutters to cut off the ball end of the new string.
- 4 Insert the tip of the string from which you cut off the ball end between the saddle and the string holder block, and tighten the string stopper bolt to fasten the string.
- 5 Wind the string onto the tuning peg, and tune it.
- 6 When you've finished tuning, tighten the pressure pad bolts of the locking nut.

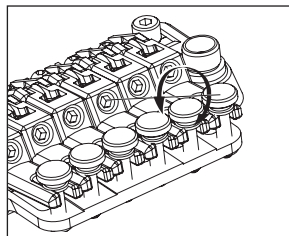

※ On tremolo bridges not equipped with the zero cross system, removing all strings at the same time will cause the tremolo attachment angle to change significantly, so we recommend that you replace the strings one at a time. If you remove all strings at the same time, tuning will be easier if you wedge a piece of cloth below the tremolo to secure it so that the tremolo attachment angle won't change significantly.

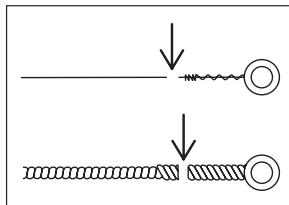

Memo

- Before you tune, make sure that the string stopper bolts are firmly tightened.

FINE TUNING

Even after you've used the locking nuts to lock the strings, you can use the fine tuners to fine-tune each string.

The range of adjustment after the strings are locked will be widest if you leave all fine-tuning bolts near the center of their adjustable range before you tune.

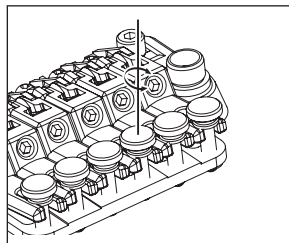

ZR TREMOLO BRIDGE

Overview

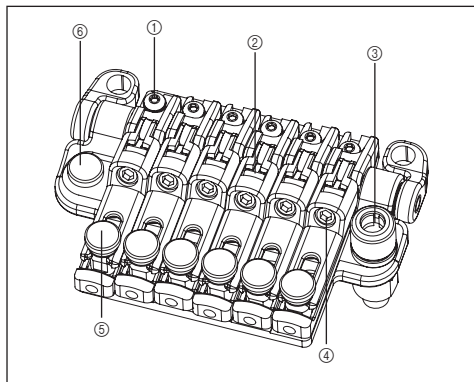

- ① saddle lock bolt
- ② string holder block
- ③ tremolo arm socket
- ④ string stopper bolt
- ⑤ fine tuning bolt
- ⑥ intonation adjustment bolt

Rear

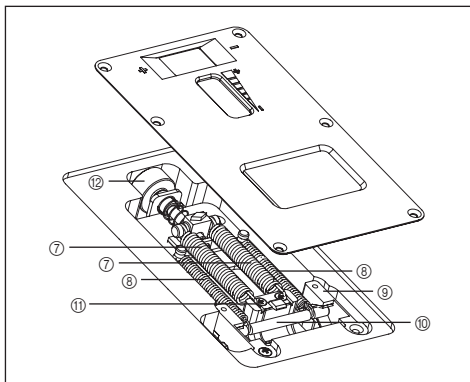

- ⑦ main spring
- ⑧ sub spring
- ⑨ stopper
- ⑩ stop rod
- ⑪ tremolo block
- ⑫ spring adjustment knob

ATTACHING THE TREMOLO ARM

- ① The tremolo arm employs a one-piece snap-in design with an adjustable-torque cap. Insert the tremolo arm into the arm socket of the base plate.
- ② Tighten the torque adjustment cap to secure the tremolo arm. The tremolo arm will become tighter as you tighten the torque adjustment cap.

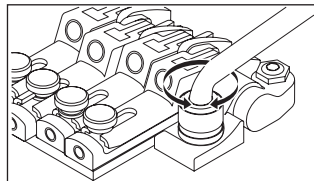
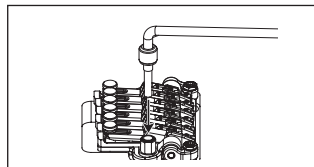

ANGLE ADJUSTMENT / ZERO POINT SYSTEM ADJUSTMENT

The tremolo attachment angle is adjusted by changing the balance between the string tension and the tension of the zero point system installed on the back of the guitar body. The ZR tremolo bridge is designed so that the tremolo will be approximately parallel with the surface of the guitar body when the zero point system is adjusted correctly, and will perform optimally in this state. When the zero point system is correctly adjusted, the stop rod will be in firm contact with the tremolo block and the stop rod will be touching the stopper.

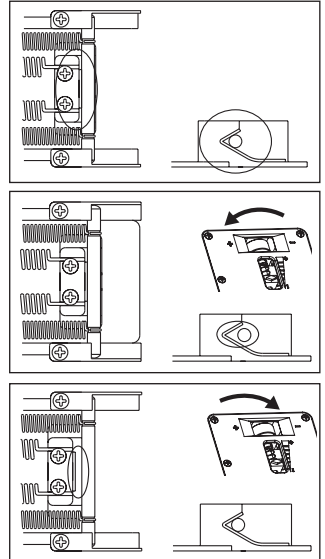

- ① With the guitar tuned correctly, check the zero point system.
- ② If the stop rod is not touching the stopper (i.e., if the tremolo block is pushing up the stop rod), turn the spring adjustment knob located on the back of the body toward the “plus” direction to tighten the main spring.
- ③ If the tremolo block is not in firm contact with the stop rod (i.e., if the tremolo is tilted toward the rear), turn the spring adjustment knob toward the “minus” direction to loosen the main spring.

DISABLING THE ZERO POINT SYSTEM (USING THE UNIT AS A CONVENTIONAL FLOATING

By disabling the zero point system you can also use the unit as a conventional floating bridge. When the zero point system is disabled, the angle at which the tremolo is attached will be adjusted by the balance between the tension of the strings and the tension of the main springs attached to the tremolo block. For optimal performance, adjust the tremolo so that it is approximately parallel with the surface of the guitar body.

- ① While holding the arm in the upward position (i.e., with the tremolo block away from the stop rod), remove the stop rod and the sub-spring.
- ② With the guitar tuned correctly, check the angle of the tremolo.
- ③ If the tremolo is tilted toward the front, turn the spring adjustment knob toward the “plus” direction to tighten the main spring.
- ④ If the tremolo is tilted toward the rear, turn the spring adjustment knob toward the “minus” direction to loosen the main spring.

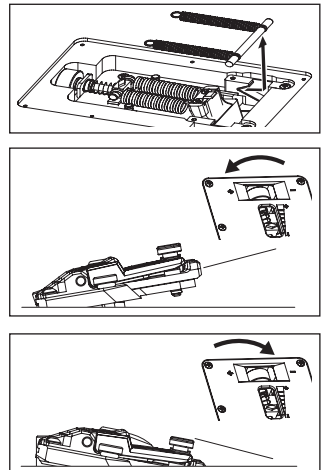

※ The tuning will be affected when you adjust the tremolo angle with the zero point system disabled, because the balance between the tension of the strings and the springs will change each time you adjust the tension of the tremolo springs. You'll need to tune repeatedly while making this adjustment.

ADJUSTING THE ACTION

To adjust the height of the entire tremolo unit, use an HEX key wrench (3 mm) to turn the stud bolts located at the left and right of the tremolo unit. (It is not possible to make adjustments for each string individually.)

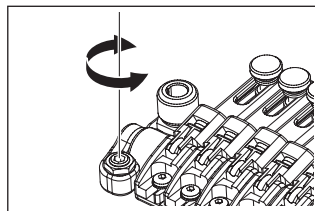

ADJUSTING THE INTONATION

- 1 Remove the intonation adjustment bolts stored inside the tremolo unit, and screw them into the adjustment holes at the back of the saddle until the tip of each bolt contacts the wall of the tremolo unit.
- 2 Use an HEX key wrench (2 mm) to loosen the saddle lock bolt, and turn the intonation adjustment bolt to adjust the saddle position.

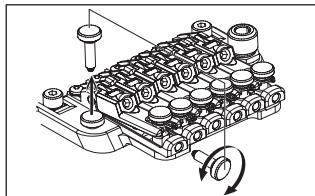

※ Before checking the intonation, firmly tighten the saddle lock bolts and tune the guitar correctly. Before tuning, use an HEX key wrench (3 mm) to loosen the pressure pad bolts of the locking nut. When you've finished making adjustments, tighten the saddle lock bolts and the pressure pad bolts of the locking nut, and store the intonation adjustment bolts inside the tremolo unit.

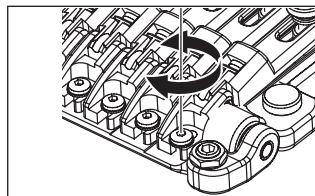

REPLACING THE STRINGS

- 1 Use an HEX key wrench (3 mm) to loosen the pressure pad bolts of the locking nut, and remove the string from the tuning peg.
- 2 Use an HEX key wrench (3 mm) to loosen the string stopper bolt of the tremolo unit; then pull the string out of the saddle and remove it.
- 3 Use wire cutters to cut off the ball end of the new string.
- 4 Insert the tip of the string from which you cut off the ball end between the saddle and the string holder block, and tighten the string stopper bolt to fasten the string.
- 5 Wind the string onto the tuning peg, and tune it.
- 6 When you've finished tuning, tighten the pressure pad bolts of the locking nut.

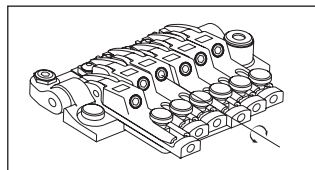
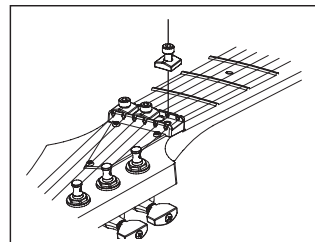

Memo

- Before you tune, make sure that the string stopper bolts are firmly tightened.

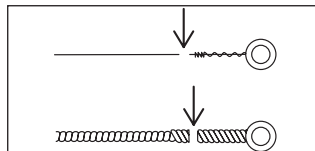

FINE TUNING

Even after you've used the locking nuts to lock the strings, you can use the fine tuners to fine-tune each string. The range of adjustment after the strings are locked will be widest if you leave all fine-tuning bolts near the center of their adjustable range before you tune.

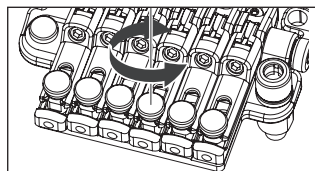

STD-DL TREMOLO BRIDGE

■ Overview

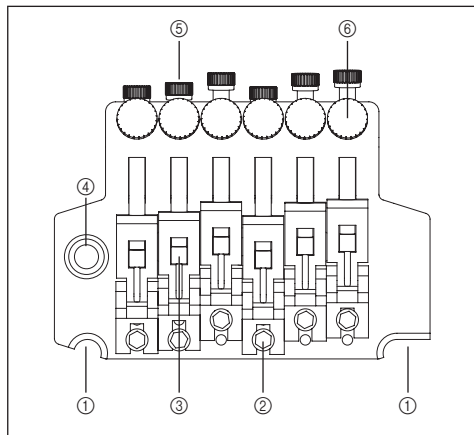

- ① knife edge
- ② saddle lock bolt
- ③ string holder block
- ④ tremolo arm socket

■ Rear

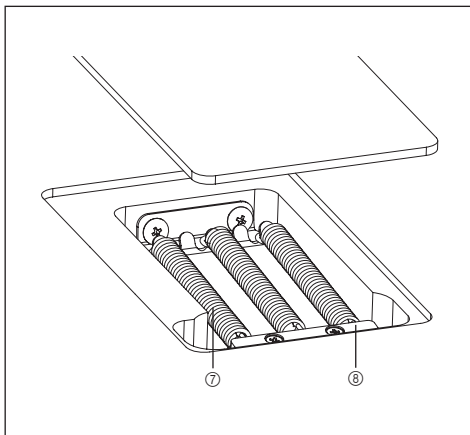

- ⑤ string stopper bolt
- ⑥ fine tuning bolt
- ⑦ tremolo spring
- ⑧ spring lock

ATTACHING THE TREMOLO ARM

- ① The tremolo arm employs a one-piece snap-in design with an adjustable-torque cap. Insert the tremolo arm into the arm socket of the base plate.
- ② Tighten the torque adjustment cap to secure the tremolo arm. The tremolo arm will become tighter as you tighten the torque adjustment cap.

ADJUSTING THE TREMOLO ATTACHMENT ANGLE

The tremolo attachment angle is adjusted by changing the balance between the string tension and the tension of the tremolo springs installed on the back of the guitar body. You'll obtain the optimal performance by adjusting this so that the tremolo is approximately horizontal to the surface of the guitar body.

- ① With the guitar tuned correctly, check the angle of the tremolo.
- ② If the tremolo is tilted toward the front, insert a Philips screwdriver through the slit in the tremolo spring cover on the back of the body, and tighten the screw to increase the tension of the tremolo springs.
- ③ If the tremolo is tilted toward the rear, loosen the screw to decrease the tension of the tremolo springs.

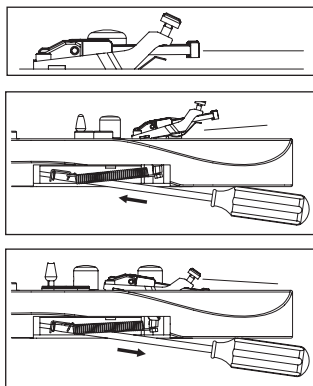

※ The tremolo angle adjustment will affect the tuning, because the balance of tension between the strings and the springs will change each time you adjust the tension of the tremolo springs. You'll need to tune repeatedly while making this adjustment.

TREMOLO SPRINGS

When the guitar is shipped from the factory, it is set up with three tremolo springs installed in parallel.

If the balance of tension between the strings and the tremolo springs has changed significantly, such as when you've switched string gauges or are using a dropped tuning, you may need to change the number of tremolo springs or change the way in which they are installed.

- 1 If you want to increase the tension, install the outer two tremolo springs diagonally.
- 2 If you want to decrease the tension, remove the center tremolo spring.

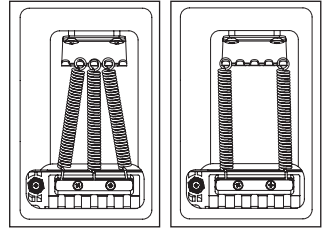

Memo

- Loosen the strings sufficiently before you install or remove tremolo springs. Be aware that if you remove all of the springs, the tremolo unit will detach from the guitar.
- To reattach the tremolo, insert the knife edge of the tremolo securely into the groove of the stud bolts, and then install the tremolo springs.

ADJUSTING THE ACTION

To adjust the height of the entire tremolo unit, use an HEX key wrench (3mm) to turn the stud bolts located at the left and right of the tremolo unit. (It is not possible to make adjustments for each string individually.)

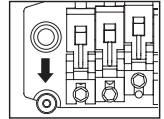

ADJUSTING THE INTONATION

- 1 Use an HEX key wrench (3 mm) to loosen the pressure pad bolts of the locking nut, and loosen the strings sufficiently.
- 2 Use an HEX key wrench (2 mm) to loosen the saddle lock bolts, and adjust the saddle position.

※ Before checking the intonation, firmly tighten the saddle lock bolts and tune the guitar correctly. When you've finished making adjustments, tighten the saddle lock bolts and the pressure pad bolts of the locking nut.

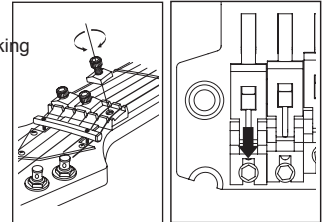

REPLACING THE STRINGS

- 1 Use an HEX key wrench (3 mm) to loosen the pressure pad bolts of the locking nut, and remove the string from the tuning peg.
- 2 Use an HEX key wrench (3 mm) to loosen the string stopper bolt of the tremolo unit; then pull the string out of the saddle and remove it.
- 3 Use wire cutters to cut off the ball end of the new string.
- 4 Insert the tip of the string from which you cut off the ball end between the saddle and the string holder block, and tighten the string stopper bolt to fasten the string.
- 5 Wind the string onto the tuning peg, and tune it.
- 6 When you've finished tuning, tighten the pressure pad bolts of the locking nut.

※ Removing all strings at the same time will cause the tremolo attachment angle to change significantly, so we recommend that you replace the strings one at a time. If you remove all strings at the same time, tuning will be easier if you wedge a piece of cloth below the tremolo to secure it so that the tremolo attachment angle won't change significantly.

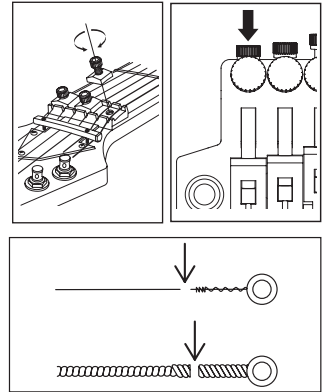

Memo

- Before you tune, make sure that the string stopper bolts are firmly tightened.

FINE TUNING

Even after you've used the locking nuts to lock the strings, you can use the fine tuners to fine-tune each string.

The range of adjustment after the strings are locked will be widest if you leave all fine-tuning bolts near the center of their adjustable range before you tune.

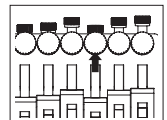

Non Locking Tremolo

SynchroniZR

■ Overview

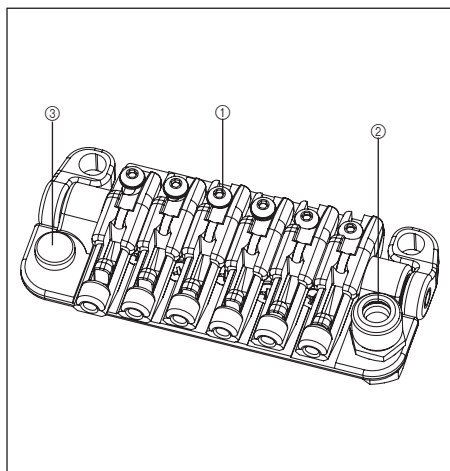

- ① Saddle lock bolt
- ② Tremolo arm socket
- ③ Intonation adjustment bolt

■ Rear

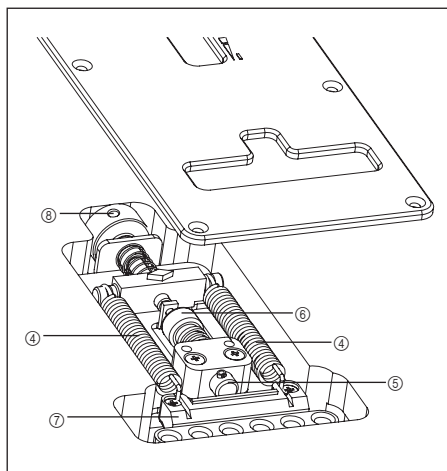

- ④ Tremolo spring
- ⑤ Tremolo block stopper
- ⑥ Tremolo block stopper knob
- ⑦ Tremolo block
- ⑧ Spring adjustment knob

ATTACHING THE TREMOLO ARM

- ① The tremolo arm employs a snap-in design. Holding the corner of the tremolo arm, press it firmly into the arm socket of the base plate until it clicks into place.

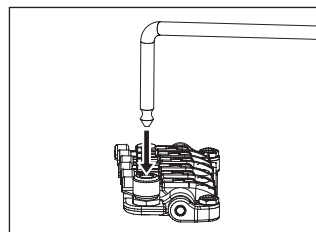

- ② The tightness of the tremolo arm can be adjusted by the torque adjustment cap. Turning the cap clockwise will make the arm tighter, and turning it counterclockwise will make the arm looser.

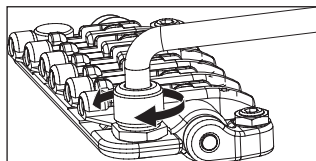

ADJUSTING THE TREMOLO ATTACHMENT ANGLE

The angle at which the tremolo is attached is adjusted by the balance between the tension of the strings and the tension of the tremolo springs installed in the back of the guitar body.

The tremolo will perform optimally when adjusted so that it is approximately parallel with the surface of the guitar body.

- 1 With the guitar tuned correctly, check the angle of the tremolo.
- 2 If the tremolo is tilted forward, turn the spring adjustment knob located on the back of the body toward the "plus" direction to tighten the tremolo springs.
- 3 If the tremolo is tilted toward the rear, turn the spring adjustment knob toward the "minus" direction to loosen the tremolo springs.

※ Because the balance of tension between the strings and the springs will change each time you adjust the tension of the tremolo springs, adjusting the tremolo angle in the floating state will affect the tuning. You'll need to tune the guitar repeatedly while performing this adjustment.

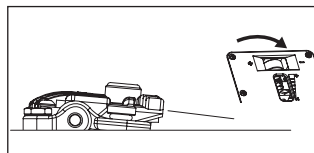
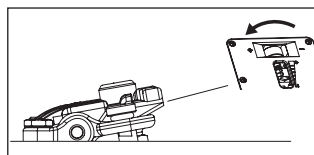
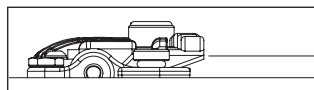

ENGLISH

ARM-UP STOPPER

The SynchroniZR has an arm-up stopper feature. This feature disables the floating state by locking the arm-up range of movement.

- 1 Make sure that the tremolo is adjusted so that it is approximately parallel with the surface of the guitar body.
- 2 Remove the tremolo spring cover, and turn the arm-up stopper knob so that the tip of the arm-up stopper contacts the tremolo block.
- 3 Once again make sure that that the tremolo is approximately parallel with the surface of the guitar body, and turn the spring adjustment knob several times in the "plus" direction.

※ If the tremolo spring tension is too weak, the tremolo block will be pulled by the strings, possibly causing the tuning to be unstable. If you experience this problem while tuning, turn the spring adjustment knob even farther in the "plus" direction.

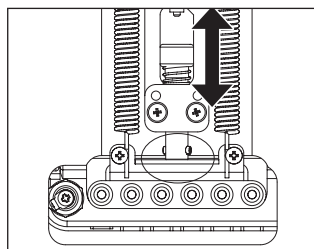

STRING HEIGHT ADJUSTMENT

To adjust the string height, adjust the height of the entire tremolo unit by using an HEX key wrench (3 mm) to turn the stud bolts located at the left and right of the tremolo unit. (It is not possible to individually adjust the height of each string.)

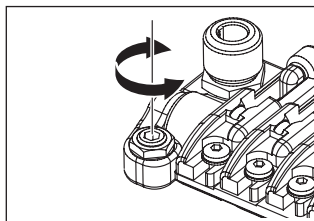

INTONATION ADJUSTMENT

1 Remove the intonation adjustment bolts stored in the tremolo unit, and screw them into the adjustment holes at the rear of the saddle until the bolt tips touch the wall of the tremolo unit.

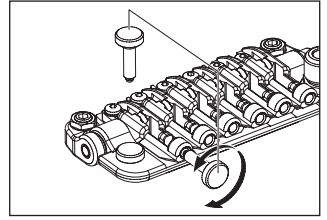

2 Use an HEX key wrench (2 mm) to loosen the saddle lock bolt, and turn the intonation adjustment bolt to adjust the saddle position.

※ Before checking the intonation, firmly tighten the saddle lock bolts and tune the guitar correctly. When you've finished making adjustments, tighten the saddle lock bolts and the pressure pad bolts of the locking nut, and store the intonation adjustment bolts inside the tremolo unit.

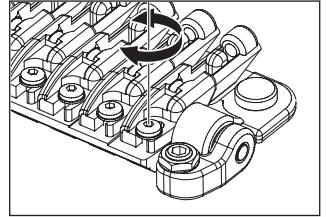

STRING REPLACEMENT

Install new strings by passing them through the tremolo block from the back side of the guitar body.

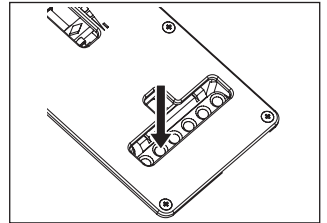

FAT/SAT/STD TREMOLO

TREMOLO ARM INSTALLATION

The tremolo arm can be inserted and removed very easily. Insert the arm into the armhole on the tremolo base plate. Pull up on the arm to remove it.

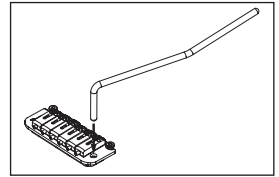

TREMOLO ARM ADJUSTMENT (SAT PRO2)

To adjust the height of the arm, remove the tremolo spring cover from the back of the guitar, and use a 3 mm HEX key wrench to turn the height adjustment screw attached to the bottom of the tremolo block. Tightening this in the clockwise direction will raise the height.

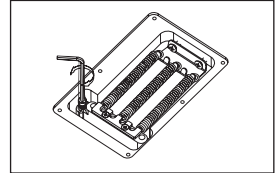

ARM ROTATION TORQUE

The rotation torque of the arm can be adjusted by raising the tremolo and inserting a 1.5mm HEX key in the screw (A) on the tremolo block. Turning this screw clockwise will tighten the arm torque and turning the screw counter clockwise will loosen the arm torque.

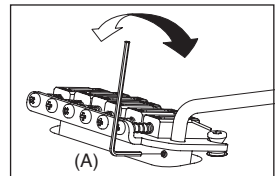

ADJUSTING THE STRING HEIGHT (SAT PRO2)

To adjust the action of each string, use a 1.5 mm HEX key wrench to turn the screw on the saddle (C). The overall height can be adjusted on either side of the SAT PRO2 tremolo unit. To adjust the height, use a 3 mm HEX key wrench to turn the stud (D) located on either side of the unit. Use caution when adjusting the height of the entire tremolo unit; adjust both sides to the same height to ensure optimum tremolo operation.

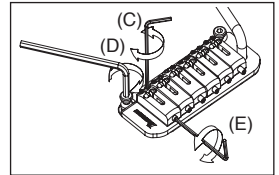

ADJUSTING THE STRING HEIGHT (FAT10/SAT10)

The height adjustment of the tremolo can be raised or lowered by adjusting the pivot studs (C) that the tremolo mounts on. These are located at either side of the front of the bridge. Clockwise lowers the tremolo and counter clockwise raises the tremolo.

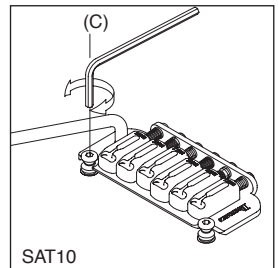
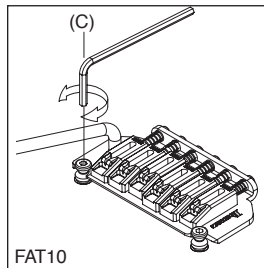

INTONATION ADJUSTMENT (SAT PRO2)

To adjust the intonation, use a 1.5 mm HEX key wrench to turn the screw located at the rear of the saddle (E). Turn the screw clockwise to move the saddle toward the rear, or counter-clockwise to move the saddle forward.

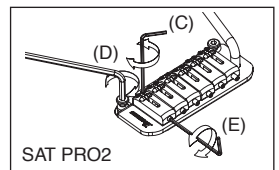

INTONATION ADJUSTMENT (FAT10/SAT10)

The intonation can be adjusted by adjusting the saddle forward or backward using a cross slot screwdriver (+) on the intonation adjustment screw at the rear of the bridge.

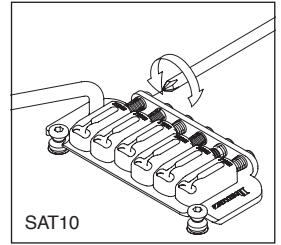
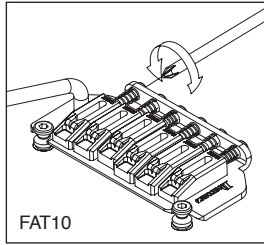

ADJUSTING THE INTONATION & THE STRING HEIGHT (FAT 6/STD)

The intonation can be adjusted by adjusting the saddle forward or backward using a cross slot screwdriver (+) at the rear of the bridge. String height is controlled by raising or lowering the small allen screws using a wrench on either side of the saddle.

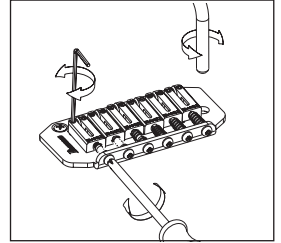

REPLACING THE STRINGS

To replace strings, thread the new strings through the string holes located on the back of the guitar. The strings are then threaded through the tremolo block and up and over the saddle.

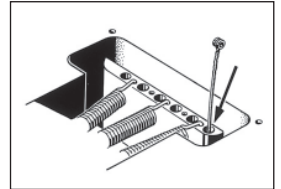

FAT/SAT (EXCEPT FAT6) ADJUSTING THE TREMOLO SPRING

A standard tremolo can be adjusted so that the pitch can be raised when the tremolo arm is pulled up to loosen the tremolo springs located under the tremolo cavity on the back of the guitar. One disadvantage of this procedure is that it can cause the pitch to go sharp if string breaks. To remedy this, adjust the tremolo plate so it sits flush on the body by tightening the tremolo springs. Choose the number and placement of the tremolo springs according to the string gauge and the tremolo adjustment .

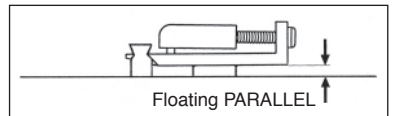
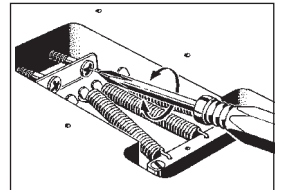

Guitar Electronics

H-S-H (5-WAY)

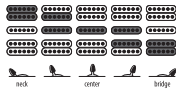

H-H (5-WAY)

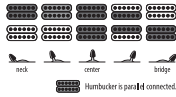

S-S-H (5-WAY)

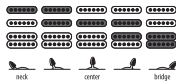

EGEN

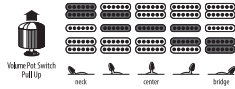
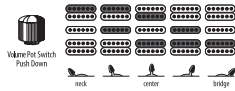

SA360

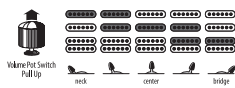
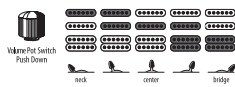

FRM

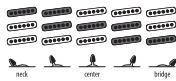

AT

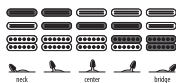

RG550XH

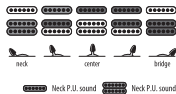

H-H (3-WAY)

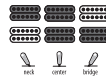

XPT700

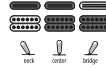

JS

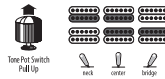
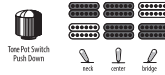

TRI-SOUND (NECK P.U.)

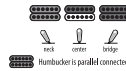

TRI-SOUND (BRIDGE P.U.)

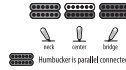

APEX

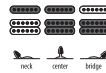

Guitar Controls

1-V, 1-T, 5 WAY LEVER SWITCH

RG, S, SA, JEM, NDM, GSA, GRX

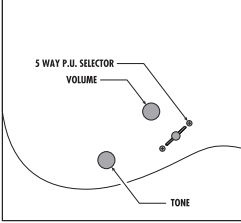

1-V, 1-T, 3 WAY LEVER SWITCH

RG, S, RGA, GRGA, GRX, GAX, GRGM

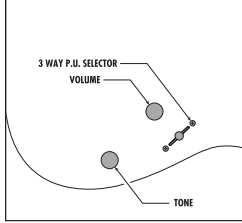

1-V, 1 PRE-SET EQ, 3 WAY TOGGLE SWITCH

RGA

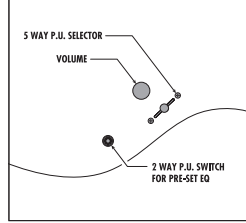

1-V, 3 WAY TOGGLE SWITCH

RGD

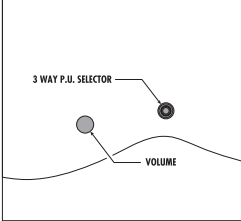

1-V, 1-T, 3 WAY TOGGLE SWITCH

IC, XPT

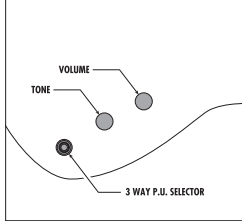

1-V, 3 WAY TOGGLE SWITCH

XF

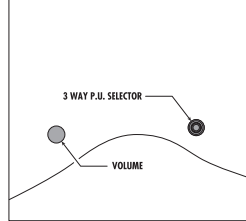

1-V, 3 WAY TOGGLE SWITCH

XH, XG, STM

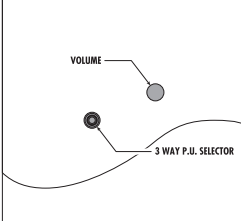

1-V, 1-T, 3 WAY TOGGLE SWITCH

DN, RC

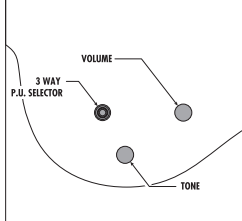

1-V, 1-T, 5 WAY LEVER SWITCH

SA

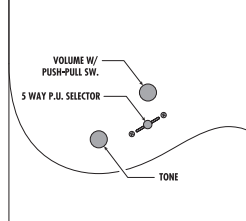

1-V, 2-T, 5 WAY LEVER SWITCH

AT

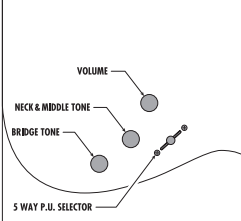

1-V, 5 WAY LEVER SWITCH

APEX

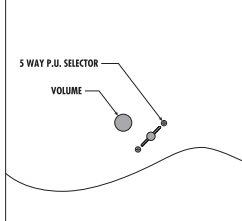

1-V, 1-T, 3 WAY TOGGLE SWITCH

JS

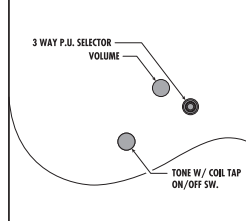

1-V, 3 WAY LEVER SWITCH

MTM

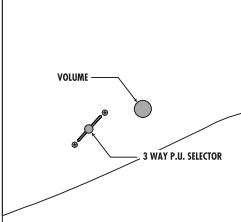

1-V, 1-T

M80M

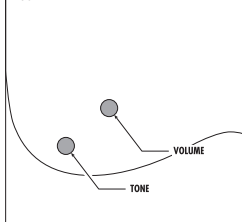

1-V, 1-T, 5 WAY LEVER SWITCH

FRM

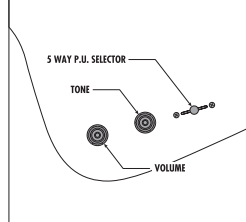

1-V

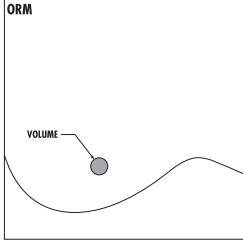

1-V, KILL SWITCH, 3 WAY LEVER SWITCH

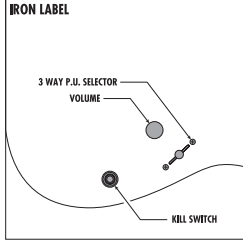

1-V, 1-T, 3 WAY TOGGLE SWITCH

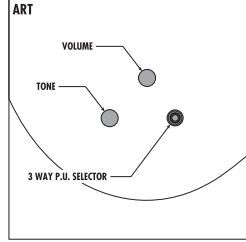

2-V, 1-T, 3 WAY TOGGLE SWITCH

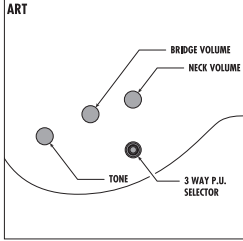

2-V, 1-T, 3 WAY TOGGLE SWITCH

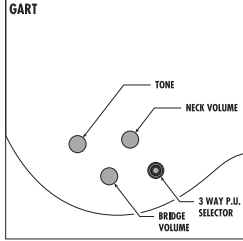

2-V, 1-T, 3 WAY TOGGLE SWITCH, TRI-SOUND NECK BRIDGE

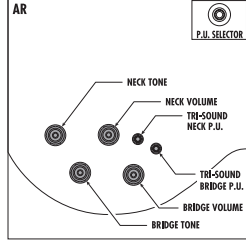

1-V, 1-T, 3 WAY TOGGLE SWITCH

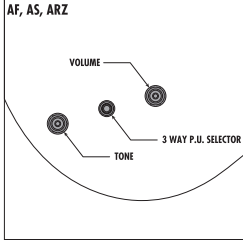

2-V, 2-T, 3 WAY TOGGLE SWITCH

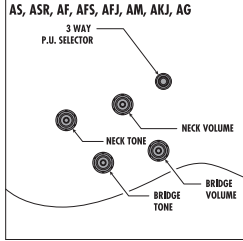

2-V, 2-T, 3 WAY TOGGLE SWITCH

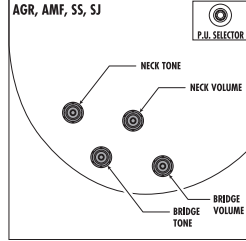

1-V, 1-T

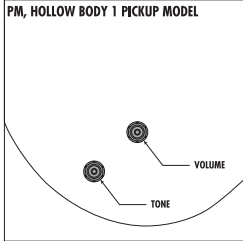

2-V, 2-T, 3WAY TOGGLE SWITCH, TRI-SOUND NECK P.U.

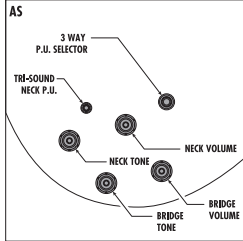

This is to certify that the aforementioned
equipments fully conform to protection
requirements of the following EC council directives.
DIRECTIVES:89/336/EEC Electromagnetic compatibility



The followings complies with the requirements of the EMC Directive
2004/108/EC of the European Union.



HOSHINO GAKKI CO., LTD.

NO.22, 3-CHOME, SHUMOKU-CHO, HIGASHI-KU,
NAGOYA, 461-8717, JAPAN

AUTHORIZED REPRESENTATIVE : **HOSHINO BENELUX B.V.**
J.N.WAGENAARWEG 9, 1422 AK UITHOORN, NETHERLANDS

Ibanez

www.ibanez.com

Ibanez © 2013 Printed in China AUG13948