

XDrum Schlagzeug Hocker

Aufbauanleitung

Sie finden die Aufbauanleitung zu Ihrem Drum Hocker online unter folgendem Link:

XDrum Semi

https://www.kirstein.de/docs/manuals/XDrum-Schlagzeughocker%20Semi-Aufbauanleitung_DE.pdf



XDrum DHS-1

https://www.kirstein.de/docs/manuals/XDrum-Schlagzeughocker%20DHS-1-Aufbauanleitung_DE.pdf



Um die Umwelt zu schützen, versenden wir diese Handbücher nicht in gedruckter Form. Sollten Sie dies dennoch wünschen, können Sie sich die Anleitungen ganz einfach unter den angegeben Links bzw. durch Scannen des QR Codes ausdrucken oder Sie kontaktieren uns direkt und wir schicken Ihnen diese in gedruckter Form per Post zu.

XDrum Drum Stool

Assembly instruction

You can find the Assembly instruction for your drum throne online under the following link:

XDrum Semi

https://www.kirstein.de/docs/manuals/XDrum-Drum%20Stool%20Semi-Assembly%20Instruction_EN.pdf



XDrum DHS-1

https://www.kirstein.de/docs/manuals/XDrum-Schlagzeughocker%20DHS-1-Assembly%20Instruction_EN.pdf



In order to protect the environment, we do not send these manuals in printed form. Should you nevertheless wish to do so, you can easily print out the instructions using the links or QR code provided or contact us directly and we will send them to you in printed form by post.



XDrum DD-250P Mesh E-Drum Kit

Item no.: 00100192



Operating instructions

Revision: 07/2024

These operating instructions are protected by copyright. Reproduction of these operating instructions, even in part, is only permitted with the permission of Musikhaus Kirstein GmbH. The same applies to the reproduction or copying of images, even in modified form.

Contents

Intended use	1
Included components	3
Assembly	4
Specifications	7
Operating elements module	8
Module connections.....	9
Get ready to play - the most important functions	9
Drum kit settings	10
Metronome settings	11
Play to a song.....	12
Bluetooth function	12
Energy-saving mode	13
Midi function.....	13
Reset to factory settings - Factory Reset	13
Index - List of drum kits and songs	14
Index - List of sounds	14
Midi notes of the pads.....	15
Simplified EU Declaration of Conformity.....	15
WEEE Declaration (Waste of Electrical and Electronic Equipment)	15

Thank you for purchasing this product. To ensure that you are completely satisfied with this product, please read and understand this instruction manual carefully before using our product. Keep these operating instructions in a safe place. The operating instructions must be passed on to all subsequent users.



Observe the operating instructions!



The signal word **WARNUNG** indicates dangers that could lead to serious injury if precautions are not taken.



The signal word **HINWEIS** indicates general precautionary measures that should be observed when handling the product.



Images and screen displayed in these operating instructions may differ slightly from the appearance of the actual product as long as this has no negative impact on the technical properties and safety of the product.



All personal formulations in these operating instructions are to be regarded as gender neutral.

These operating instructions apply to persons who have been supervised or instructed in the operation of the appliance by a person responsible for their safety and who have demonstrated that they can handle the appliance.

All information in these operating instructions has been checked to the best of our knowledge and belief. However, neither the author nor the publisher can be held liable for any damage arising in connection with the use of these operating instructions.

Other product, brand and company names mentioned in this document may be the trademarks of their respective owners. Compliance with all applicable copyright laws is the responsibility of the user of this document.

Intended use



- Only use the product in accordance with the instructions given here. Failure to follow these instructions will invalidate the warranty! Musikhaus Kirstein GmbH accepts no liability for any resulting damage.
- Unauthorized conversions or modifications to the product are not permitted for safety reasons and will also invalidate the warranty.
- Do not open or modify the device or the power supply unit.
- Make sure that the installation complies with the standards and regulations applicable in your country.
- This product is intended for indoor use only.
- Never use or store the device in places exposed to extreme or humid temperatures or rain.
- Check the item for possible damage before putting it into operation.
- Installation is only permitted on a stable and solid surface. An appropriate substructure may need to be provided.
- Do not place any open light sources (candles, etc.) on or next to the product.
- Only operate the product from an earthed mains socket.



- Do not allow any liquids or moisture to penetrate the housing.
- Disconnect the appliance from the power supply when not in use.
- Disconnect the appliance from the mains during a thunderstorm.
- The device does not contain any user-serviceable parts. Always consult appropriately trained specialist personnel.
- Lay the mains cable so that people cannot fall over it.
- Turn the volume control to the lowest level before switching on.
- Only use the power adapter supplied with the device. Also ensure that the mains voltage matches the input voltage indicated on the AC adapter housing. Other adapters may use a different polarity or be designed for a different voltage, so their use may result in damage, malfunction or electric shock.
- Only use the mains cable supplied. The mains cable supplied must not be used with other devices. Do not twist the power cable excessively and do not place any heavy objects on it. This can damage the cable and lead to short circuits. Damaged cables pose an increased risk of fire and electric shock.
- This device can be used in combination with an amplifier or headphones, which can lead to permanent hearing loss. Do not operate the device at an uncomfortable level for long periods of time. If you notice hearing loss or ringing in the ears, you should stop using the device immediately and consult a doctor.
- Protect the device from strong impacts. Do not drop it.
- Unplug the power supply unit at regular intervals and clean it with a dry cloth by removing all dust and dirt from the pins. Any accumulation of dust between the mains plug and the socket can lead to poor insulation and fire.
- Never climb on the appliance or place heavy objects on it.
- Never touch the power supply unit with wet hands when plugging it in or unplugging it. Disconnect the power supply unit and all cables from external devices before moving the device.
- Before cleaning the appliance, switch it off and disconnect the mains adapter from the socket.
- Do not connect this appliance to the same socket used by an electrical appliance that is controlled by an inverter (e.g. refrigerator, washing machine, microwave) or that contains a motor. Depending on the way the electrical appliance is used, noise from the power supply may cause this appliance to malfunction or produce audible noise.
- Using the device in the vicinity of power amplifiers or other devices with large power transformers can cause humming.
- To solve the problem, change the orientation of this device or move it further away from the source of interference. This device may interfere with radio and television reception.
- Interference noise can be generated when wireless communication devices such as cell phones are operated near this device. Such noise may occur when receiving or initiating a call or during a conversation. If such problems occur, you should place such wireless devices at a greater distance from this device or switch them off.
- Do not expose the device to direct sunlight, place it near devices that radiate heat, leave it in a closed vehicle or otherwise expose it to extreme temperatures. Excessive heat can deform or discolor the device.
- If the appliance is moved from one place to another where the temperature and/or humidity is very different, water droplets (condensation) may form inside the appliance. Damage or malfunctions may result if you attempt to use the appliance in this condition. Therefore, leave the appliance for a few hours before use until the condensation has completely evaporated.
- For daily cleaning, wipe the appliance with a soft, dry cloth or a cloth slightly moistened with water. To remove stubborn dirt, use a cloth impregnated with a mild, non-abrasive cleaning agent. Then wipe the appliance thoroughly with a soft, dry cloth. Never use benzene, thinner, alcohol or solvents of any kind.

Included components

Before assembling the e-drum for the first time, please check that you have received all the necessary components.

You can find a list of the included components here:



1. Drum module
2. 7" Drum pad
3. 8" Cymbal pad
4. 4.5" Bass drum pad
5. Kick pedal for bass drum pad
6. HiHat controller
7. Rack
8. Rack foot
9. Cymbal arm
10. HiHat arm
11. Multicore cable

- A. Power supply unit
- B. Rubber for cymbals
- C. Washer for HiHat
- D. Screw for HiHat
- E. Tuning key
- F. Cable velcro
- G. Drum pad & module holder
- H. Screws for drum pads & module

Assembly

1. Assembly of the rack system

Insert the rack (7) into the rack feet (8) and secure it by tightening the wing screws on the rack feet (8). This also allows you to set the desired height of the e-drum. Now you can loosen the wing screws of the individual rack rods to turn the rack rods to the desired position.

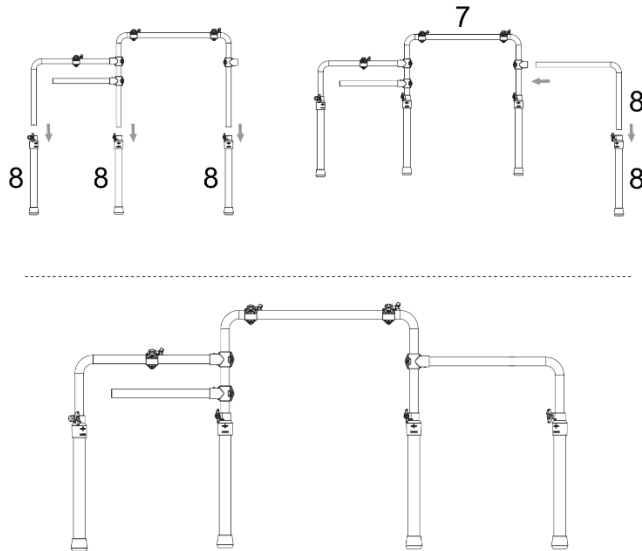

2. Attaching the drum pads

Place the two 7" drum pads (2) on the top horizontal rack bar and secure them with the drum pad holders (G) and the screws for drum pads (H). The screws can be tightened with the tuning key (E).

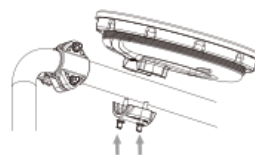
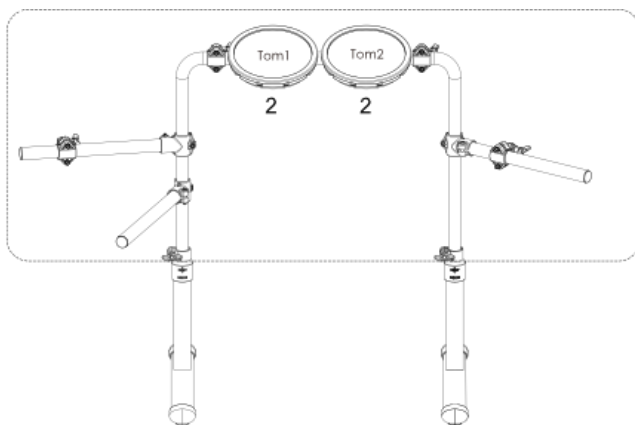

Now place the two remaining 7" drum pads (2) on the lower left rack rod and on the right rack rod and secure them with the drum pad holders (G) and the screws for drum pads (H). The screws can be tightened with the tuning key (E).

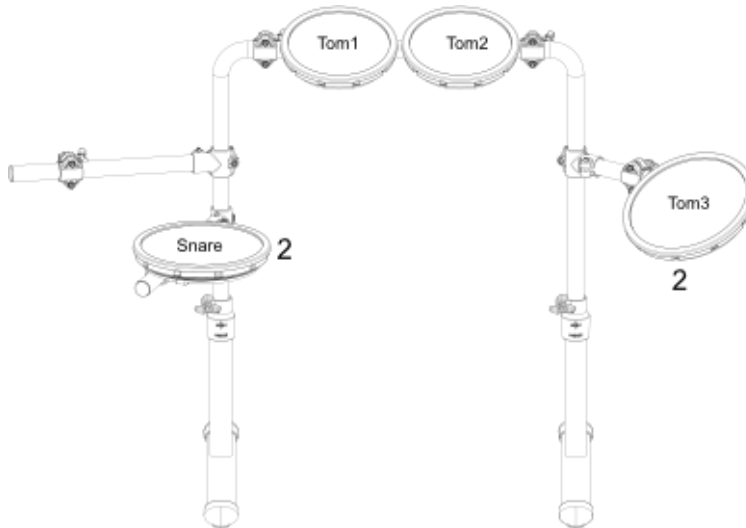

3. Attaching the module

Place the drum module (1) on the upper left rack bar and secure the drum module with the module holder (G) and the screws for the module (H). The screws can be tightened with the tuning key (E).

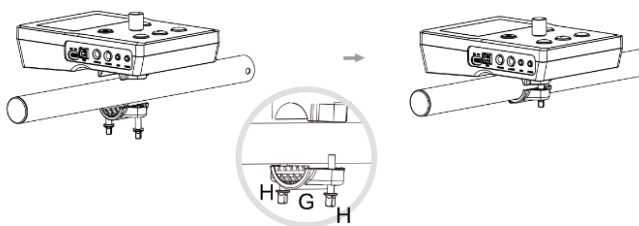
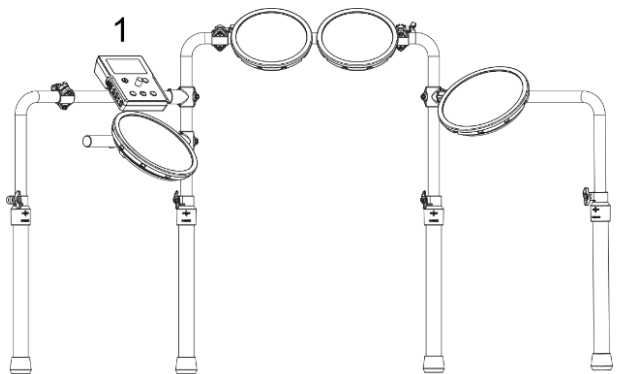

4. Mounting the HiHat and cymbal arms

Place the two cymbal arms (9) in the rack clamps on the top horizontal rack bar and fix the cymbal arms in the rack clamps with the wing screws.

The HiHat arm (10) should be attached to the upper left rack bar. To do this, this arm must also be inserted into the rack clamps and can be fixed to the rack clamps with the wing screws.

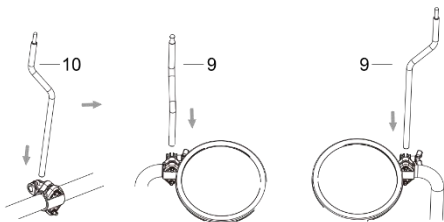
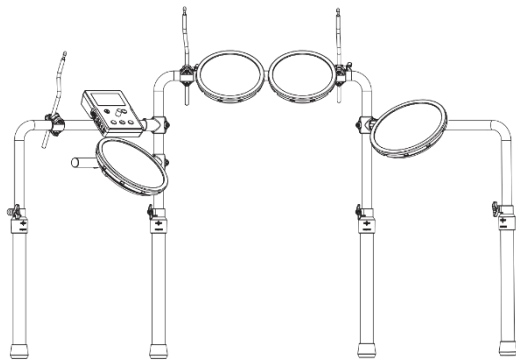

5. Attaching the HiHat and cymbal pads

Put a washer (C) onto the HiHat arm (10). Now place an 8" cymbal pad (3) on this arm and then put another washer (C) on the cymbal pad from above. Finally, you can screw the screw for the HiHat (D) onto the washer to fix the cymbal in place. The crash and ride cymbals are fitted by placing the two remaining 8" cymbal pads (3) on the cymbal arms (9) and securing the cymbals from above with the rubber for cymbals (B).

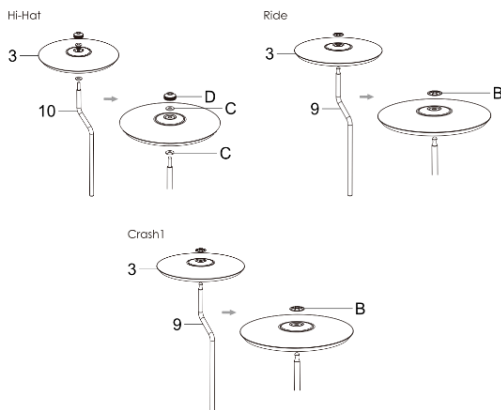
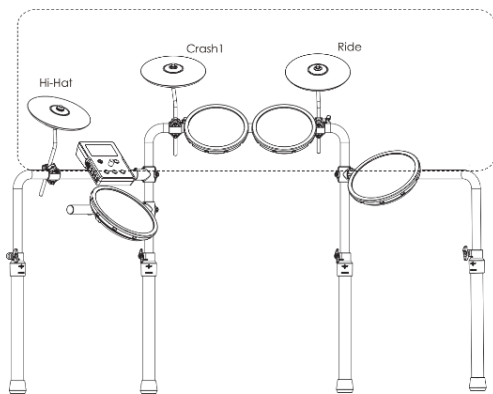

6. Cabling of the individual components

The multicore cable is labeled at the individual ends with the corresponding names of the components to be connected. Use the following diagram to help you connect the module to the various components.

The module must also be connected to a socket using the power supply unit supplied in order to supply the device with power. The cable velcros (F) can be used to fix the cables to the rack.

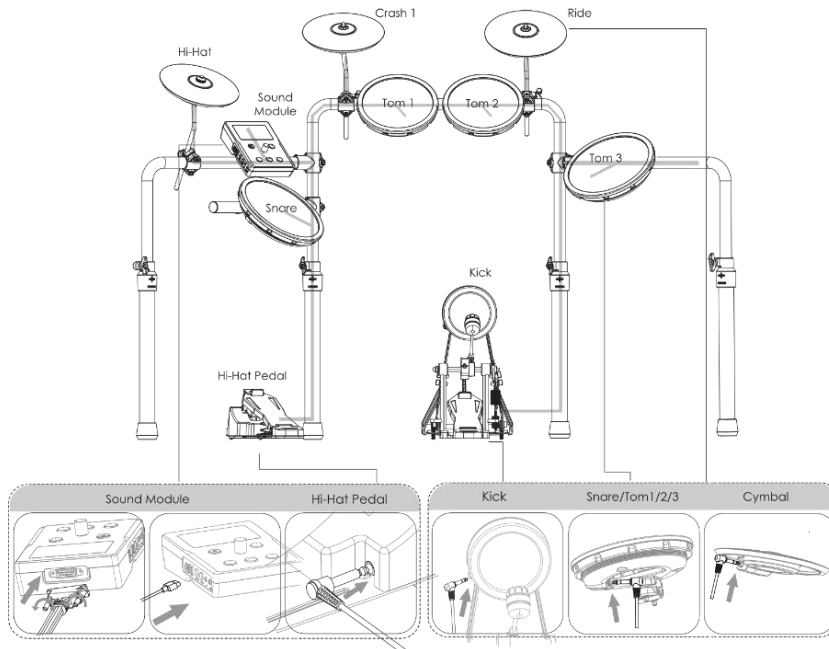

Specifications

Songs	10
Preset kits	12
Sounds	74
Metronome Tempo	20-320 BPM
Display	Three Digital Tube
Power supply connection	Type C, 5V, 1A
Connections	USB (USB type B, USB midi)
	AUX (3.5mm stereo jack)
	L/Mono (6.35mm stereo jack)
	Phone (3.5mm stereo jack)
	Components Multicore
	Crash 2 connection (6.35mm stereo jack)

Operating elements module

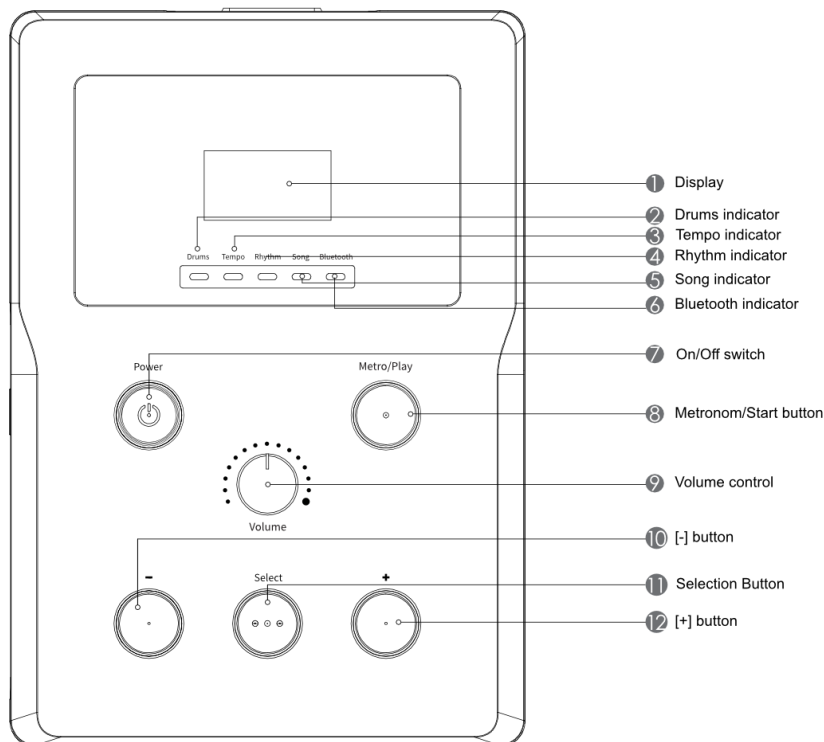

1. Display: For displaying various information.

2. Drums indicator (Drums): Indicates that you are in Drums mode.

3. Tempo indicator (Tempo): Indicates that you are in tempo mode.

4. Rhythm indicator (Rhythm): Indicates that you are in rhythm mode.

5. Song indicator (Song): Indicates that you are in song mode.

6. Bluetooth indicator (Bluetooth): Indicates that the module is connected via Bluetooth.

7. On/Off switch (Power): Use this button to switch the module on or off.

8. Metronome and start button (Metro/Play): Use this button for various metronome functions, starting/stopping songs, usage mode and to confirm factory reset.

9. Volume control (Volume): Use this control to increase or decrease the overall volume.

10. [-] button: Use this button to reduce various parameters.

11. Selection button (Select): Use this button to select/confirm various parameters.

12. [+] button: Use this button to increase various parameters.

Module connections

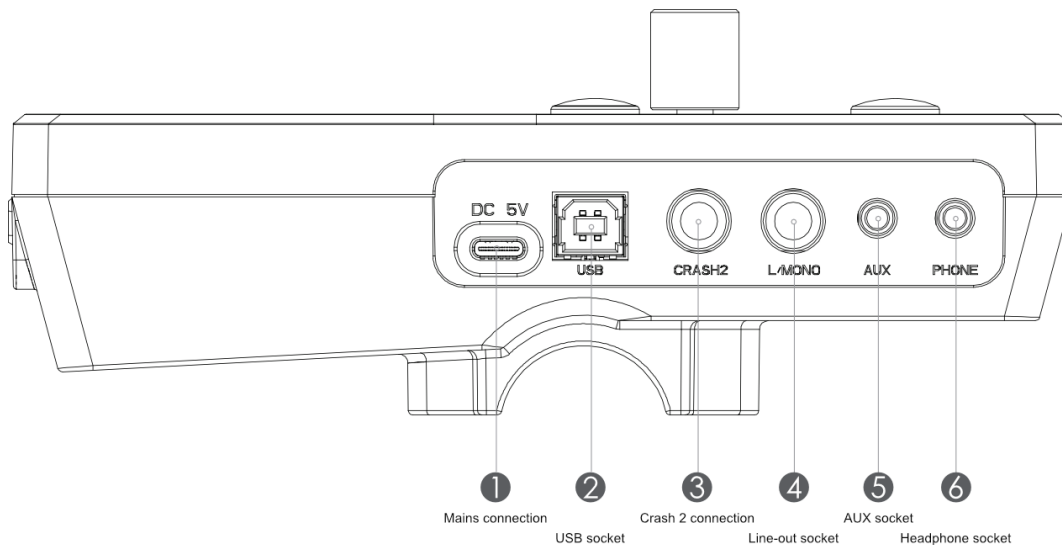

1. Mains connection (DC 5V):

Connect the supplied type C power supply unit (DC 5V, 1A) here to supply the e-drum with power.

2. USB socket (USB):

Connect the module to your computer via USB cable (USB-A - USB-B) to send and receive Midi data and to receive USB audio data.

3. Crash 2 connection (Crash 2):

Connect a second optional crash cymbal here using a 6.3 mm jack cable.

4. Line-out socket (L/mono):

Use this connection to connect your e-drum to an external amplifier, active speaker, PA system, etc. via a 6.3 mm jack cable. This allows you to hear the sound of the instrument loudly, e.g. to play with other musicians.

5 AUX socket (AUX):

Connect your external audio source (cell phone, MP3 player, laptop, etc.) via a 3.5 mm jack cable to play along with your own songs.

6. Headphone socket (Phone):

For quiet practicing at home, we recommend using this headphone connection (3.5mm jack). The sound is still played back via the line-out socket, even though headphones are connected.

Get ready to play - the most important functions

Switching on the module

1. Turn the volume knob (Volume) anticlockwise to reduce the volume completely. Also set the volume of the connected external amplifier to 0.
2. Press the on/off button (Power) to switch the device on.

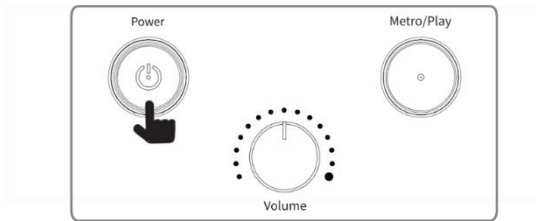

3. Now switch on the external amplifier, active speaker, system, etc.

4. Now you can carefully adjust the volume upwards. You can check the volume during this process by hitting the drum pads.

*After switching on, the module is in drums mode by default and the drums indicator lights up.

Switching off the module

1. Press the On/Off button (Power) a little longer until the display shows "Off".



2. Minimize the volume of the connected external audio sources.

3. Switch off the external connected audio sources.

Drum kit settings

1. Press the selection button (Select) to switch to drum mode. After switching on, the module is in drums mode by default and the Drums indicator lights up.

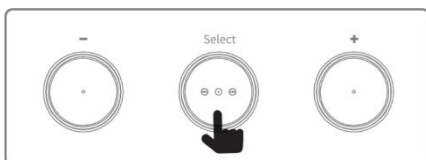

2. The drum kit number appears on the display, press the [+] or [-] button to select a drum kit from the list (12 in total).

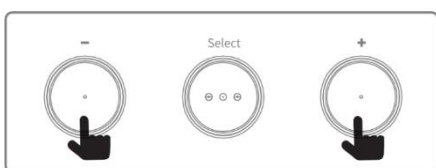

Metronome settings

Changing the metronome tempo

1. Press the selection button (Select) to select the tempo mode of the metronome. The tempo indicator should light up.
2. The display shows the tempo in the form of a number.
The tempo stands for beats per minute (bpm) and the setting range is between 20 and 320 bpm.



3. Use the metronome button (Metro/Play) to switch the metronome on. Pressing it again deactivates the metronome.

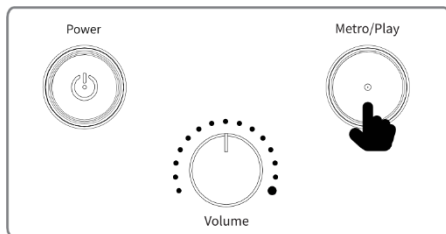

4. Press the [+] or [-] buttons to change the tempo. You can change the tempo more quickly by holding down the buttons.

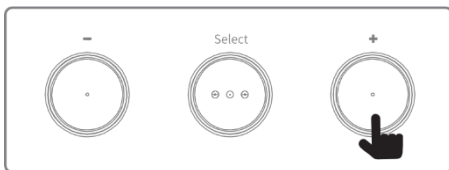

Changing the metronome volume









1. Press and hold the metronome button (Metro/Play) in tempo mode to set the metronome volume.
2. The volume value appears on the screen (20 levels in total).



3. Press the [+] or [-] buttons to change the volume.
4. Press and hold the metronome button (Metro/Play) to exit the volume setting and save the settings.
Alternatively, you can also briefly press the Select button to exit the current setup status and switch to the next mode.

Changing the metronome rhythm

1. Use the selection button (Select) to select the rhythm mode of the metronome.
2. The set rhythm appears on the display. In rhythm mode, press the [+] or [-] buttons to set the rhythm.

Display	Description
	1/4 would mean quarter note gets one beat and one beat per measure.
	2/4 would mean quarter note gets one beat and two beats per measure.
	3/4 would mean quarter note gets one beat and three beats per measure.
	4/4 would mean quarter note gets one beat and four beats per measure.
	5/4 would mean quarter note gets one beat and five beats per measure.
	6/4 would mean quarter note gets one beat and six beats per measure.
	7/4 would mean quarter note gets one beat and seven beats per measure.
	8/4 would mean quarter note gets one beat and eight beats per measure.
	9/4 would mean quarter note gets one beat and nine beats per measure.

Play to a song

1. Use the Select button to switch to Song mode.
2. Use the [+] or [-] buttons to select the desired song. The display will show the current song number (10 songs in total).



3. Press the start button (Metro/Play) to play the song. Press this button again to pause the song.
4. You can also activate the metronome during the song.
When the metronome is switched off, press and hold the metronome button (Metro/Play) to switch it on.
When the metronome is switched on, press and hold the metronome button (Metro/Play) to switch it off.
5. To mute the drum track within the song, press the metronome button (Metro/Play) at the same time as the minus button (-).



Bluetooth function

When the module is switched on, Bluetooth is switched on automatically. Now activate the Bluetooth connection on the device of your choice (e.g. cell phone or tablet), search for the device "MUSICPRO" followed by 4 random numbers and letters and establish a connection. When the Bluetooth indicator lights up, this means that Bluetooth is successfully connected. Now you can start music via your device and listen to it via headphones or an amplifier, active speaker, system, etc. and play along with it.

Energy-saving mode

If this function is activated, the device switches off automatically if no signal is received from one of the input sockets or pads for a certain period of time.

1. With the module switched off, press and hold the metronome button (Metro/Play) and then press the On/Off button (Power) to switch the device on.
2. The current value appears on the screen. Press the [+] or [-] buttons to change the automatic switch-off time (unit: minutes).

Display	Description
	Auto power off function is disabled when the value is 0.
	Auto power off function is enabled when the value is greater than 0 and the set time is exceeded. (Unit: minute)

3. Press the metronome button (Metro/Play) to enter the usage mode. Press and hold the power button to turn off the device and complete the setting. The setting will not be saved if an abnormal operation such as a power failure occurs. A normal shutdown will save the current settings.

Midi function

MIDI is a worldwide standard communication interface that allows electronic musical instruments and computers/laptops/etc. to communicate with each other and exchange data. The USB connection allows a direct connection to a computer. No separate drivers need to be installed on the PC/laptop or similar, as these are already included in the module. To use the module, connect it to your computer via the USB socket (USB) using a USB cable (USB-A - USB-B) to send Midi data. The module is recognized as a USB audio device and sends MIDI data. Please check the manual of the DAW software you are using, as the USB audio device to be used may need to be assigned separately.

Reset to factory settings - Factory Reset

This process resets all settings of the e-drum to their original factory settings.

1. When the device is switched off, press and hold the Select button and then press the Power button to switch the device on. The screen will display the following:



2. Press the metronome button (Metro/Play) to confirm the factory reset. If you want to cancel the factory reset, press and hold the On/Off button (Power) to switch the device off.

The factory settings are as follows: Drum Kit Mode (01), Song (S-01), Metronome Tempo (60), Metronome Rhythm (4/4), Metronome Volume (L-20), Power Off (00).



Index - List of drum kits and songs

INDEX 1 - DRUM KIT List

NUM	NAME	NUM	NAME
1	Classic	7	Pop
2	Rock	8	Gospel
3	Fusion	9	Jazz
4	Blues	10	Reggaes
5	Metal	11	Concrete
6	Funk	12	Fix

INDEX 2 - SONG List

NUM	NAME	NUM	NAME
1	Demo 1	6	Demo 6
2	Demo 2	7	Demo 7
3	Demo 3	8	Demo 8
4	Demo 4	9	Demo 9
5	Demo 5	10	Demo 10

Index - List of sounds

INDEX 3-VOICE List

NUM	NAME
Crash	
1	Crash-B-Track 1.B_16-Edgep
2	Crash-Z.K_16 Edge
3	Crash-Z-Track 1.A_18 Edgep
4	Crash-Z-Track 1.K_18 Edgep
5	Crash-Synth Arena 1
6	Crash-Stab Jack 5
7	Crash-B.B_18-EdgeRoll
8	Crash-B.M_18-EdgeRoll
9	Crash-China-Z.A_20.xdi
10	Crash-S.HX_16-EdgeRoll
11	Crash-Splash-B.Z_8
12	Crash-Splash-Z.K_10
13	Crash-Z.A_16 Edge
Hi-Hat	
14	HH-Chick-B.B_14
15	HH-Chick-Master 14
16	HH-Chick-I.AX_17
17	HH-Chick-Bass Concrete 1
18	HH-Chick-Shaker BottlePoppin 2
19	HH-Closed-B.B_14-Edge 3
20	HH-Closed-Master 14-Edge 3
21	HH-Closed-I.AX_17-Edge 3
22	HH-Closed-Z.K_14-Edge 3
23	HH-Closed-Z.A_14-Edge 3
24	HH-Close-Concrete 4
25	HH-Close-Alphabetical 1
26	HH-Open-B.B_14-Edge
27	HH-Open-Master 14-Edge
28	HH-Open-I.AX_17-Edge
29	HH-Open-Z.K_14-Edge
30	HH-Open-Z.A_14-Edge
NUM	NAME
59	Tom1-Dakeat 2
60	Tom1-Buzz Dakeat 1
Tom2	
61	Tom2-Blues 5
62	Tom2-Classic 5
63	Tom2-5_fusion
64	Tom2-Metal 5
65	Tom2-Rock 5
66	Tom2-Dakeat 3

NUM	NAME
31	HH-Open-Concrete 4
32	HH-Open-Alphabetical
Kick	
33	Kick-Blues 7
34	Kick-Classic 7
35	Kick_fusion-7
36	Kick-Metal 7
37	Kick-Rock 7
38	Kick-Concrete 4
39	Kick-Ganja 4
Ride	
40	Ride-Z.K_20 Top
41	Ride-Z.A_20 Top
42	Ride-B.M_20-Top
43	Ride-Master 20-Top3p
44	Ride-M.S_22-Top 3p
45	Ride-Clap Jack 3
46	Ride-Orgami
Snare	
47	Snare-Blues 9
48	Snare-Classic 9
49	Snare-9_fusion
50	Snare-Metal 9
51	Snare-Rock 9
52	Snare-Concrete 7
53	Snare-Arena 2
Tom1	
54	Tom1-Blues 5
55	Tom1-Classic 5
56	Tom1-5_fusion
57	Tom1-Metal 5
58	Tom1-Rock 5
NUM	NAME
67	Tom2-SFX Dakeat 2
Tom3	
68	Tom3-Blues 5
69	Tom3-Classic 5
70	Tom3-5_fusion
71	Tom3 -Metal 5
72	Tom3-Rock 5
73	Tom3-SFX Dakeat 2
74	Tom3-Buzz Dakeat 3

Midi notes of the pads

Kick	Midi note 0x24
Snare	Midi note 0x26
Tom 1	Midi Note 0x30
Tom 2	Midi note 0x2d
Tom 3	Midi note 0x2b
HiHat Open	Midi note 0x2e
HiHat Closed	Midi note 0x2a
HHPedal	Midi note 0x2c
Crash 1	Midi Note 0x31
Crash 2 (optional)	Midi Note 0x39
Ride	Midi note 0x33

Simplified EU Declaration of Conformity

Hereby, Musikhaus Kirstein GmbH declares that the radio equipment type (XDrum DD-250P Mesh E-Drum Kit) is in compliance with Directive 2014/53/EU. The full text of the EU Declaration of Conformity is available at the following internet address:
http://www.kirstein.de/docs/Konformitaetserklaerung/CE_Konformitaetserklaerung_00100192.pdf

WEEE Declaration

(Waste of Electrical and Electronic Equipment)

Your product has been developed and manufactured using high-quality materials and components that are recyclable and reusable. The symbol means that your product must be disposed of separately from household waste at the end of its service life. Dispose of this appliance at your local collection point or recycling center. Please help to protect the environment in which we all live.

All technical data and appearances are subject to change without prior notice. All information was correct at the time of printing. Musikhaus Kirstein GmbH accepts no liability for the accuracy or completeness of the descriptions, photos or statements contained in this manual. Printed colors and specifications may differ slightly from the product. Musikhaus Kirstein GmbH products are only sold through authorized dealers. Distributors and dealers are not representatives of Musikhaus Kirstein GmbH and are not authorized to legally bind Musikhaus Kirstein GmbH in any way.

 **KIRSTEIN.de**

Musikhaus Kirstein GmbH
Bernbeurener Str. 11
86956 Schongau - Germany
info@kirstein.de
Telefon/Phone: 0049-8861-909494-0
Fax/Fax: 0049-8861-909494-19

