

Classic Cantabile KH-238 Kopfhörer HiFi dynamisch

ArtNr.: 00016331



Bedienungsanleitung

Version: 10.2024

Vielen Dank, dass Sie sich für dieses Produkt entschieden haben. Um sicherzustellen, dass Sie mit dem Classic Cantabile Kopfhörer voll und ganz zufrieden sind, lesen Sie sorgfältig und verstehen Sie diese Bedienungsanleitung, bevor Sie unser Produkt verwenden. Bewahren Sie diese Bedienungsanleitung an einem sicheren Ort auf. Die Bedienungsanleitung muss an alle nachfolgenden Anwender weitergegeben werden.



Bedienungsanleitung beachten!



WARNUNG

Mit dem Signalwort **WARNUNG** sind die Gefahren gekennzeichnet, die ohne Vorsichtsmaßnahmen zu schweren Verletzungen führen können.



HINWEIS

Mit dem Signalwort **HINWEIS** sind allgemeine Vorsichtsmaßnahmen gekennzeichnet, die im Umgang mit dem Produkt beachtet werden sollen.



HINWEIS

Bilder und Bildschirmdarstellungen in dieser Bedienungsanleitung können vom Erscheinungsbild des tatsächlichen Produkts geringfügig abweichen, solange dies keine negativen Auswirkungen auf die technischen Eigenschaften und Sicherheit des Produkts hat.



HINWEIS

Alle personenbezogenen Formulierungen in dieser Bedienungsanleitung sind geschlechtsneutral zu betrachten.

Diese Bedienungsanleitung gilt für Personen, die von einer für ihre Sicherheit verantwortlichen Person beaufsichtigt oder in die Bedienung des Gerätes eingewiesen wurden und nachgewiesen haben mit dem Gerät umgehen zu können.



WARNUNG

**Kinder sollten beaufsichtigt werden, um sicherzustellen, dass sie nicht mit dem Kopfhörer spielen.
Der Kopfhörer ist kein Spielzeug**

Alle Informationen in dieser Bedienungsanleitung wurden nach bestem Wissen und Gewissen kontrolliert. Weder Autor noch Herausgeber können jedoch für Schäden haftbar gemacht werden, die in Zusammenhang mit der Verwendung dieser Bedienungsanleitung stehen.

Sonstige, in diesem Dokument aufgeführte Produkt-, Marken- und Unternehmensbezeichnungen können die Warenzeichen ihrer jeweiligen Eigentümer sein. Die Einhaltung sämtlicher anwendbarer Urheberrechtsgesetze liegt in der Verantwortung des Anwenders dieses Dokuments.

Detaillierte Sicherheitshinweise:**⚠ HINWEIS**

- Lesen Sie diese Anweisungen und bewahren Sie diese Anleitung auf.
- Beachten Sie alle Warnungen. Befolgen Sie alle Anweisungen.
- Verwenden Sie dieses Gerät nicht im Wasser.
- Reinigen Sie das Gerät nur mit einem trockenen Tuch.
- Legen Sie das Gerät nicht in auf Wärmequellen wie Heizkörpern, Öfen oder andere Geräte, die Wärme erzeugen.
- Achten Sie auf die Lautstärke! Hören mit zu hohem Lautstärkepegel kann Ihr Gehör dauerhaft schädigen.
- Wenden Sie sich bezüglich aller Reparatur- /Wartungsarbeiten an qualifiziertes Servicepersonal. Öffnen Sie das Gerät bzw. das Gehäuse nicht eigenmächtig. Eine Wartung ist erforderlich, wenn das Gerät auf irgendeine Weise beschädigt wurde, z. B. wenn das Kabel beschädigt ist, Flüssigkeit verschüttet wurde oder das Gerät Regen oder Feuchtigkeit ausgesetzt war, nicht ordnungsgemäß funktioniert.

**Beschreibung:****Funktion:**

Der Kopfhörer kann mit jedem Abspielgerät (z.B. CD-Player) als auch Instrument (z.B. E-Drumset, Keyboard oder Piano) verbunden werden. Hierbei ist je nach Buchse lediglich auf den Einsatz der korrekten 3,5 mm Klinke oder der 6,3 mm Klinke des Adapters zu achten.(Adapter liegt bei)

⚠ WARNUNG

Achten Sie auf die Lautstärke! Hören mit zu hohem Lautstärkepegel kann Ihr Gehör dauerhaft schädigen.

Wartung

Ihr Gerät erfordert keine besondere Wartung. Wenden Sie sich jedoch im Falle einer Fehlfunktion an ein zugelassenes Servicecenter oder den Hersteller

Reinigung

Verwenden Sie zur Reinigung ein fusselreies und nur leicht feuchtes Tuch.

Technische Spezifikationen:

System: dynamische Kopfhörer

Nennimpedanz: 32 Ohm

Lautsprecher: Stereo

Frequenzbereich: 20-20000 Hz

Empfindlichkeit: 110dB SPL

WEEE-Erklärung

(Waste of Electrical and Electronic Equipment)

Ihr Produkt wurde unter Verwendung hochwertiger Materialien und Komponenten entwickelt und hergestellt, die recycelbar und wiederverwendbar sind. Das Symbol bedeutet, dass Ihr Produkt am Ende seiner Lebensdauer vom Hausmüll getrennt entsorgt werden muss.

Entsorgen Sie dieses Gerät bei Ihrer örtlichen Sammelstelle oder Recyclingstelle. Bitte helfen Sie mit, die Umwelt zu schützen, in der wir alle leben.

Alle technischen Daten und Erscheinungsbilder können ohne vorherige Ankündigung geändert werden. Alle Angaben waren zum Zeitpunkt der Drucklegung korrekt. Die Musikhaus Kirstein GmbH übernimmt keine Gewähr für die Richtigkeit oder Vollständigkeit der in diesem Handbuch enthaltenen Beschreibungen, Fotos oder Aussagen. Gedruckte Farben und Spezifikationen können geringfügig vom Produkt abweichen. Produkte der Musikhaus Kirstein GmbH werden nur über autorisierte Händler vertrieben. Distributoren und Händler sind keine Vertreter der Musikhaus Kirstein GmbH und nicht befugt, die Musikhaus Kirstein GmbH in irgendeiner Weise rechtlich zu binden.

Diese Bedienungsanleitung ist urheberrechtlich geschützt. Die Vervielfältigung dieser Bedienungsanleitung, auch auszugsweise, ist nur mit Genehmigung der Musikhaus Kirstein GmbH gestattet. Gleiches gilt für die Vervielfältigung oder das Kopieren von Bildern, auch in geänderter Form.

© 2024

 **KIRSTEIN.de**

Musikhaus Kirstein GmbH

Bernbeurener Str. 11

D-86956 Schongau

info@kirstein.de

www.kirstein.de

Telefon/Phone: +49(0)8861 / 90 94 94 -0



Classic Cantabile KH-238 Headphones HiFi dynamic

Item number: 00016331



User Manual

Version: 10.2024

Thank you for choosing this product.

To ensure that you are fully satisfied with the Classic Cantabile headphones, read this manual carefully and understand these instructions before using our product. Keep these operating instructions in a safe place. The operating instructions must be passed on to all subsequent users.



Please carefully follow the instructions!



WARNING

The signal word **WARNING** indicates the dangers that can lead to serious injuries without precautionary measures.

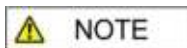

NOTE

The signal word **NOTE** indicates general precautionary measures that should be observed when handling the product.

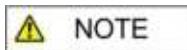

NOTE

Images and screen shots in this manual may differ slightly from the appearance of the actual product as long as this has no negative effects on the technical properties and safety of the product.

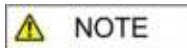

NOTE

All personal formulations in these operating instructions are to be considered gender-neutral.

These operating instructions apply to persons who have been supervised by a person responsible for their safety or who have been instructed in the operation of the device and have demonstrated that they can handle the device.



WARNING

Children should be supervised to ensure that they do not play with the device.

Do not leave children unattended. The product is not a toy!

All information in this operating manual has been checked to the best of our knowledge and belief. However, neither the author nor the publisher can be held liable for any damage associated with the use of this manual.

Other product, brand and company names mentioned in this document may be the trademarks of their respective owners. Compliance with all applicable copyright laws is the responsibility of the user of this document.

Detailed safety information:**⚠ NOTE**

- Read these instructions. Keep these instructions.
- Heed all warnings. Follow all instructions.
- Do not use this device near water.
- Only clean the device with a dry cloth.
- Do not block any ventilation openings.
- Do not place the device near heat sources such as radiators, stoves or other devices that generate heat.
- Pay attention to the volume! Hearing at a high-volume level can permanently damage your hearing.
- Contact qualified service personnel for all repair / maintenance work. Do not open the device or the housing yourself. Maintenance is required if the device has been damaged in any way, e.g., if the power cord or plug is damaged, liquid has been spilled or objects have fallen into the device, the device has been exposed to rain or moisture, is not working properly or has been dropped.

**Function:**

The headphones can be connected to every playing device (e.g., CD-players) as well as instrument (e.g., E-drumset, keyboard or piano). It is only important to note which jack plug is required for the used device: the 3.5 mm jack or the 6.3 mm jack of the adapter. (Adapter is included in delivery)

⚠ WARNING

Pay attention to the volume! Hearing at a high-volume level can permanently damage your hearing.

Maintenance

Your device does not require any special maintenance. However, in the event of a malfunction, contact an approved service center or the manufacturer

Cleaning

Use a lint-free and only slightly damp cloth for cleaning.

Technical specifications:

System: dynamic headphones

Impedance: 32 Ohm

Speakers: Stereo

Frequency range: 20-20000 Hz

Sensitivity: 110dB SPL

WEEE declaration (Waste of Electrical and Electronic Equipment)

Your product has been developed and manufactured using high quality materials and components that are recyclable and reusable. The symbol means that your product must be disposed of separately from household waste at the end of its service life.

Dispose of this device at your local collection or recycling centre, please help protect the environment we all live in.

All technical data and appearances are subject to change without notice. All information was correct at the time of printing. Musikhaus Kirstein GmbH assumes no liability for the correctness or completeness of the descriptions, photos or statements contained in this manual. Printed colours and specifications may differ slightly from the product. Musikhaus Kirstein GmbH products are only sold through authorized dealers. Distributors and dealers are not representatives of Musikhaus Kirstein GmbH and are not authorized to bind Musikhaus Kirstein GmbH legally in any way.

This manual is protected by copyright. Reproduction of these operating instructions, in whole or in part, is only permitted with the approval of Musikhaus Kirstein GmbH. The same applies to the duplication or copying of images, even in modified form.

© 2024

 **KIRSTEIN.de**

Musikhaus Kirstein GmbH

Bernbeurener Str. 11

D-86956 Schongau

info@kirstein.de

www.kirstein.de

Phone: +49(0)8861 / 90 94 94 -0



FUNKEY

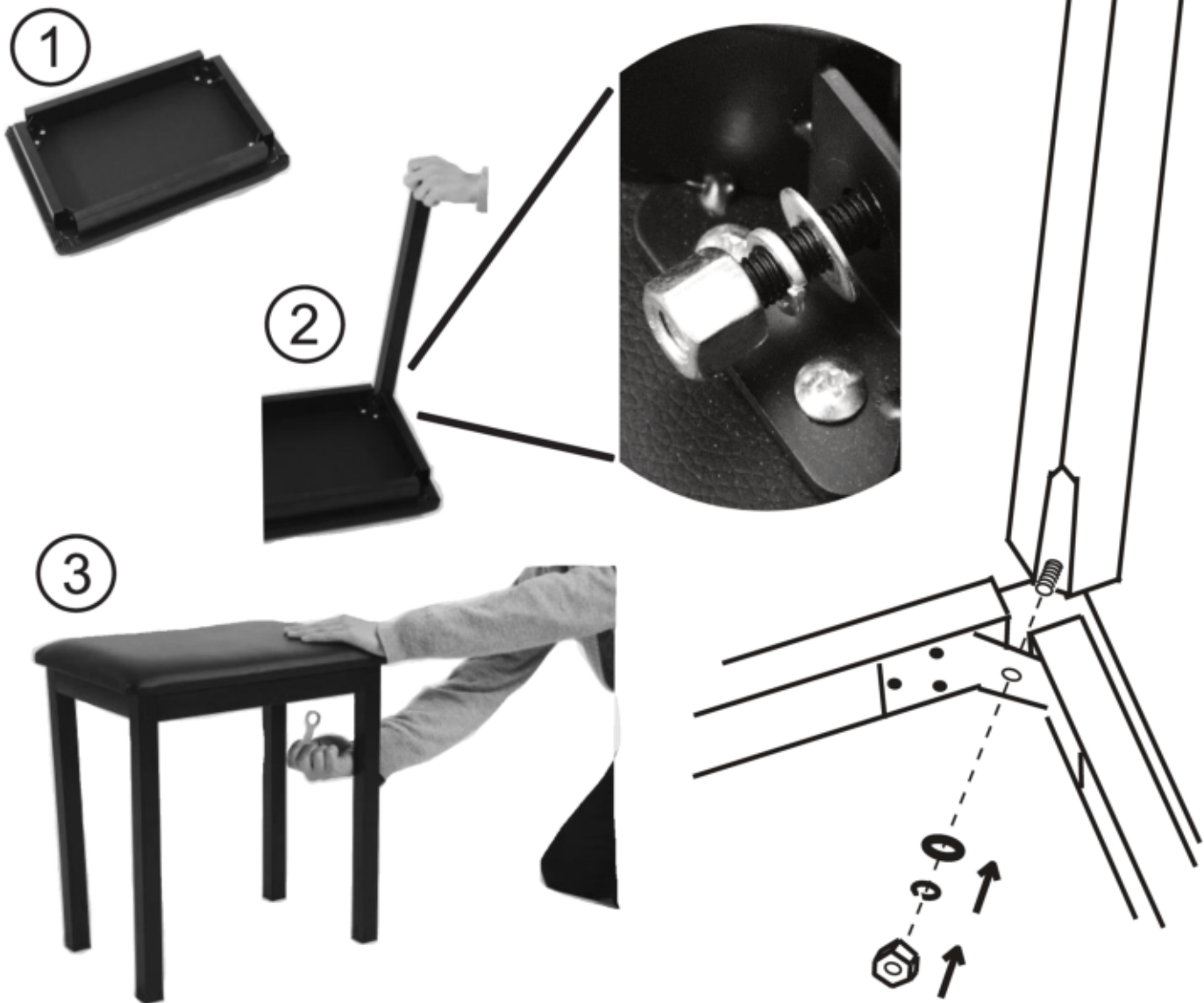

VORSICHTSMASSNAHMEN (BITTE SORGFÄLTIG DURCHLESEN) Kinder sollten beaufsichtigt werden, um sicherzustellen, dass sie dieses Produkt nicht als Spielzeug verwenden. Lassen Sie Kinder niemals unbeaufsichtigt mit dem Verpackungsmaterial spielen. Warnhinweise: Stellen Sie das Produkt stets auf eine geeignete Oberfläche ab, um ein Wackeln oder Umfallen zu verhindern. Vorsichtsmaßnahmen: Um Schäden am Produkt zu vermeiden, stellen Sie es nicht an Plätze mit hohen Temperaturen oder viel Staub, stellen Sie es nicht direkt neben eine Klimaanlage und vermeiden Sie direkte Sonneneinstrahlung. Wenden Sie im Umgang mit dem Produkt keinerlei Gewalt an und stellen Sie keine zu schweren Gegenstände darauf. Ort Setzen Sie das Produkt nicht den folgenden Bedingungen aus, um Verformungen, Verfärbungen oder größere Schäden zu vermeiden: Direktes Sonnenlicht, extreme Temperatur oder Luftfeuchtigkeit, übermäßig staubiger oder schmutziger Ort, starke Vibrationen oder Stöße. Reinigung: Reinigen Sie das Produkt nur mit einem weichen, trockenen Tuch. Verwenden Sie keine Farbverdünner, Lösungsmittel, Reinigungsfüssigkeiten oder chemisch imprägnierte Wischtücher. Handhabung: Üben Sie keine übermäßige Kraft auf Bedienelemente wie z.B. Schalter, Knöpfe, Tasten aus. Technische Änderungen und Änderungen im Erscheinungsbild sind vorbehalten. Alle Angaben entsprechen dem Stand bei Drucklegung. Für die Richtigkeit und Vollständigkeit der enthaltenen Beschreibungen, Abbildungen und Angaben übernimmt Musikhaus Kirstein GmbH keinerlei Gewähr. Abgebildete Farben und Spezifikationen können geringfügig vom Produkt abweichen. Musikhaus Kirstein GmbH - Produkte sind nur über autorisierte Händler erhältlich. Distributoren und Händler sind keine Handlungsbevollmächtigten von Musikhaus Kirstein GmbH und haben keinerlei Befugnis, die Musikhaus Kirstein GmbH in irgendeiner Weise, sei es ausdrücklich oder durch schlüssiges Handeln, rechtlich zu binden. Diese Bedienungsanleitung ist urheberrechtlich geschützt. Jede Vervielfältigung, bzw. jeder Nachdruck, auch auszugsweise, und jede Wiedergabe der Abbildungen, auch in verändertem Zustand, ist nur mit schriftlicher Zustimmung der Firma Musikhaus Kirstein GmbH gestattet.

PRECAUTIONS (PLEASE READ CAREFULLY) Children should be supervised to ensure that they do not use this product as a toy. Never let children play with the packaging material unsupervised. Warning: Always place the product on a suitable surface to prevent it from wobbling or falling over. Precautions: To avoid damage to the product, do not place it in places with high temperatures or a lot of dust, do not place it directly next to an air conditioner and avoid direct sunlight. Do not use force when handling the product and do not place objects that are too heavy on it. Location Do not expose the product to the following conditions to avoid warping, discoloration, or major damage: direct sunlight, extreme temperature or humidity, excessively dusty or dirty location, strong vibration or shock. Cleaning: Only clean the product with a soft, dry cloth. Do not use paint thinners, solvents, cleaning fluids, or chemically impregnated wipes. Handling: Do not exert excessive force on controls such as Switches, buttons, buttons off. Technical changes and changes in appearance are reserved. All information corresponds to the status at the time of printing. Musikhaus Kirstein GmbH assumes no liability for the correctness and completeness of the descriptions, illustrations and information contained. Shown colors and specifications may differ slightly from the product. Musikhaus Kirstein GmbH - Products are only available through authorized dealers. Distributors and dealers are not authorized representatives of Musikhaus Kirstein GmbH and have no authority to bind Musikhaus Kirstein GmbH legally in any way, be it expressly or through coherent action. This manual is protected by copyright. Any duplication or reprint, even in part, and any reproduction of the images, even in a modified state, is only permitted with the written consent of Musikhaus Kirstein GmbH.



DP-19 digital piano

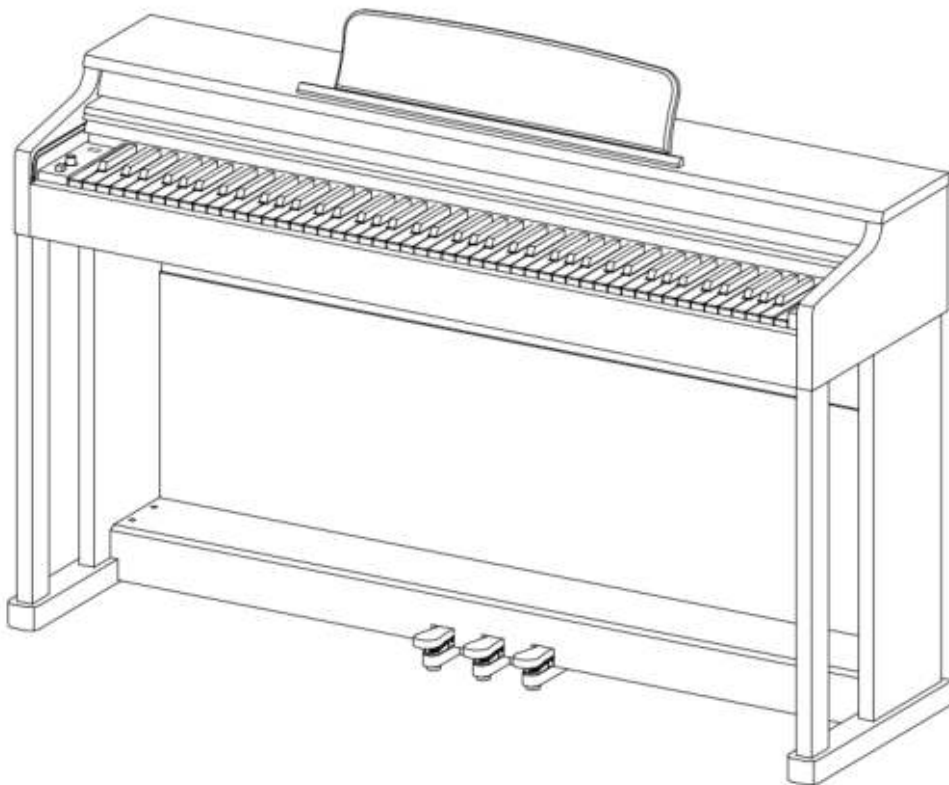

User manual

Version: 08/2023

Thank you for choosing this product.

To ensure that you are fully satisfied with this product, carefully read and understand this manual before using this instrument. Keep this manual in a safe place. The operating instructions must be passed on to all subsequent users.



Observe operating instructions!



WARNING

The **WARNING** signal word identifies hazards that, without precautions, could result in serious injury.

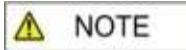

NOTE

The signal word **NOTE** indicates general precautions that should be observed when handling the product.

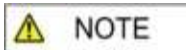

NOTE

Images and screen images in this manual may differ slightly from the actual product's appearance, as long as it does not adversely affect the technical characteristics and safety of the product.

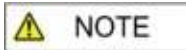

NOTE

All personal phrasing in this manual should be considered gender neutral.

These operating instructions apply to responsible persons and users who have been supervised by a person responsible for their safety or instructed in the operation of the device and who have proven to be able to handle the device.



WARNING

**Children should be supervised to ensure that they do not use this device as a toy.
Never allow children to play unattended with the packaging material.**



WARNING

Danger of property damage! We are not liable for accidents that occur as a result of non-observance of the safety instructions or due to incorrect handling.

All information in this manual has been checked to the best of our knowledge and belief. However, neither author nor publisher can be held liable for any damage related to the use of this manual.

Other product, brand and company names mentioned herein may be the trademarks of their respective owners. Compliance with all applicable copyright laws is the responsibility of the user of this document.



Caution

Please observe the following basic information in order not to endanger yourself or others and to avoid damage to external devices.

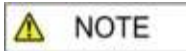

Warning

Do not disassemble the instrument and do not modify it. This could result in electric shock. Entrust a specialist workshop with any necessary service and maintenance or contact your dealer.

If you notice that the power cord is showing signs of wear, the unit shows malfunctions, burns, smells or smokes, unplug the power cord immediately and have a technician repair it. Before you clean the instrument, you should disconnect it from the mains power.

Always place the instrument on a level, stable surface to ensure a secure footing.

Do not use the instrument in a damp or wet environment.

Do not place vessels that are filled with liquids on the instrument, such as vases, glasses or bottles.

Do not place small objects on it that could slip in, such as hairpins, sewing needles or coins.

Do not place burning candles on the instrument.

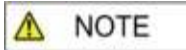

Precautions

To avoid damage to the instrument, do not place it in places with high temperatures or dust, do not place it next to an air conditioner and avoid direct sunlight.

Do not place the instrument near other electrical equipment to avoid interference.

Do not use force when handling the instrument or place heavy objects on it.

Disconnect the instrument from the power if you are not going to use it for a long time. To disconnect the device from the mains, pull the plug, not the cable. Please handle the power cable with care. It should not be near radiators, you should not place heavy objects on it and move it so that people can not step on it or fall over it.

Please note that continuous high volume can permanently damage your hearing. Adjust the volume carefully.



Power adapter

Please connect the supplied power adapter to a power outlet with the correct voltage. Do not connect it to mains voltages other than those for which the instrument is intended. Unplug the power cord if you are not going to use the product for a long time or if there is upcoming a thunderstorm.

© 2023

These operating instructions are protected by copyright. The reproduction of these operating instructions, even in part, is only permitted with the approval of Musikhaus Kirstein GmbH.

The same applies to the reproduction or copying of images, even in modified form.

Table of contents

Assembly	5
Headphone jacks	7
Operating elements	8
Operating unit	8
POWER	8
VOLUME	8
SEL (SELECT).....	8
SET (SETTING).....	8
TRA (TRANSPOSE)	8
MP3.....	8
Functions of the SEL key(SELECT)	9
Selecting a timbre	9
Mixing two timbres (DUAL VOICE).....	9
Selection of a rhythm accompaniment	9
Demo	10
Demo Loop	10
STOP.....	10
Functions of the SET key (SETTING)	10
Touch sensitivity	10
Effects	11
Metronome	11
Tempo	11
Beat	12
Recording function.....	12
Rhythm Group	12
Playing with auto accompaniment.....	13
Function of the TRA key (TRANSPOSE)	13
Transpose.....	13
Brief overview of the function assignment of the keyboard keys	14
MP3 player	15
Product specifications	15
Trouble Shooting.....	16

Assembly

First prepare the two side parts ① of the substructure for assembly.

Fasten the side parts to the pedal bar ② using two screws ⑦ each.

Now carefully bring the connecting plate ⑤ into position and fasten it using eight screws ⑦.

Then insert two wooden dowels ⑥ from each side into the pedestal brackets ③ and insert them into the side parts ① as shown in the figure below. Now carefully place the console ④ onto the base. Have a second person help you to do this.

Now fix the console to the substructure with four screws ⑦.

The plug of the pedal cable can now be connected to the matching socket **on the underside of the console**. To do this, be sure to observe the correct position of the plug in relation to the socket. Do not use force or twist the plug.

Finally, insert the hollow plug of the supplied power supply into the power supply socket on the back of the instrument.

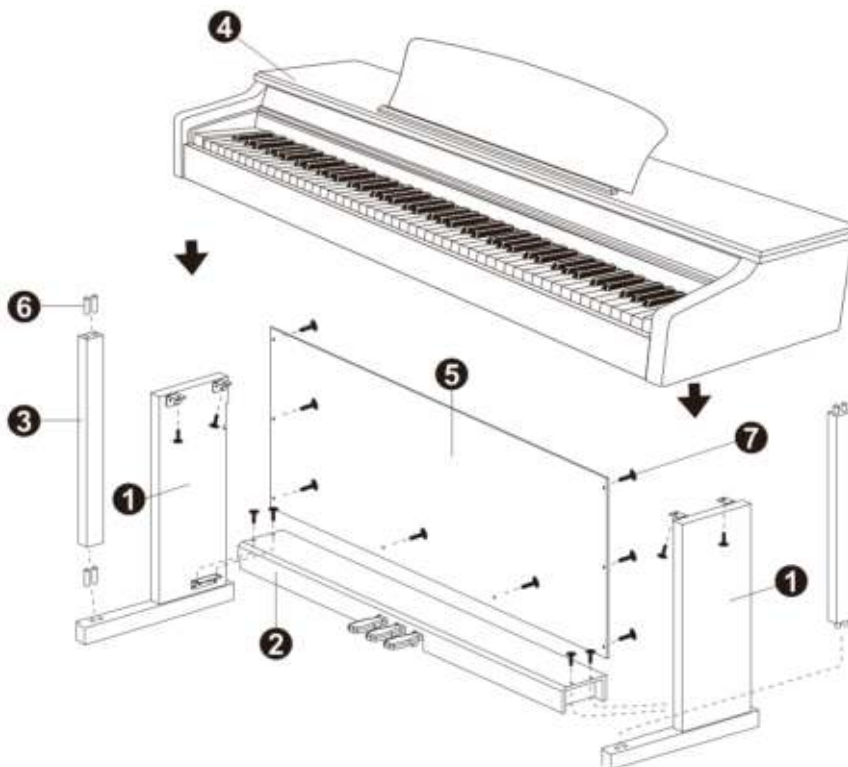

► It may be useful to keep the packing materials in case the instrument needs to be transported to a distant location.

Rear connection panel

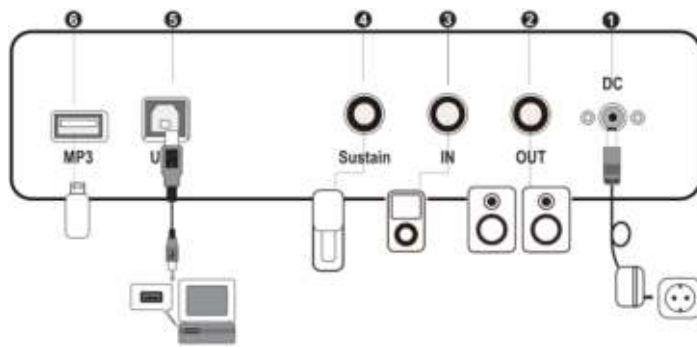

① Power supply socket

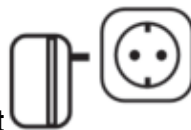

Only use the instrument with the supplied power supply unit.
First connect the hollow plug of the power supply unit to the power supply unit socket on the instrument. Then connect the power supply unit to the power socket.

② AUX Out



The AUX Out connector allows you to connect your piano to a music amplifier.

③ AUX IN:



The AUX In input allows you to play music signals from an external music source through your piano's speakers.

④ Sustain



In case of using the instrument without a substructure, you can connect a sustain pedal with 6.3mm jack socket (not included) here.

⑤ USB to Host



The USB to Host jack allows you to connect your piano to a computer using a USB A->B cable.

⑤ USB to Device



You can play MP3 data via your instrument using the USB to Device socket (identical function to the USB socket on the control panel).

Headphone jacks

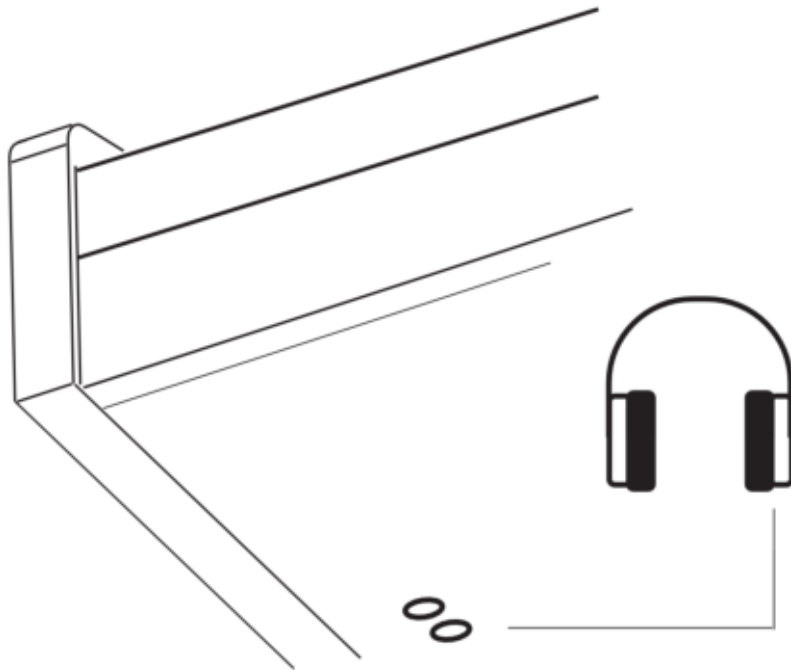

The two 6.3mm headphone jacks on the underside of the console can be used simultaneously. When connecting headphones, the instrument's speakers are deactivated.

Ensure that the volume setting is appropriate. Too high a volume or using headphones for too long can cause hearing damage.

Operating elements



Operating unit

Your digital piano is operated by a combination of the SEL, SET and TRA keys on the control panel and certain keyboard keys. A quick overview of the keyboard keys' function assignments can be found following the following function descriptions.

POWER

Use the power switch to start up your instrument. Please switch off your instrument when not in use to save energy.

VOLUME

This knob allows you to adjust the volume of your piano playing.

SEL (SELECT)

With this key you can control the main functions in connection with certain keyboard keys.

SET (SETTING)

This button allows you to select specific settings in connection with certain keyboard keys.

TRA (TRANSPOSE)

This key allows you to transpose in connection with certain keyboard keys.

MP3

Please refer to the chapter "**MP3 player**" for the operation of the MP3 player.

Functions of the SEL key(SELECT)

Selecting a timbre

To select a tone, press and hold the SELECT button on the control panel and use the keyboard range B6-B7 to select the desired tone.

For sound hold **SEL** (Select)-Button and press keyboard key



Mixing two timbres (DUAL VOICE)

To sound two tones simultaneously, first select the first of the two desired tones as described in the section "Selecting a timbre". Now press and hold the SELECT key and activate the DUAL VOICE function by pressing the A6 keyboard key. Unless otherwise selected, the "String" timbre will now be played in addition to the timbre already selected. If the DUAL VOICE function is activated, the second timbre can now be selected if required. To do this, also proceed as described under "Selecting a timbre". To deactivate the DUAL VOICE function, press and hold the SELECT key and deactivate the DUAL VOICE function by pressing the A6 keyboard key.

For dual voice hold **SEL** (Select)-Button and press keyboard key



Selection of a rhythm accompaniment

To select a drum rhythm, press and hold the SELECT button on the control panel and use the keyboard range G#3-D#6 (Rhythm) to select the desired rhythm.

For rhythm hold **SEL** (Select)-Button and press keyboard key

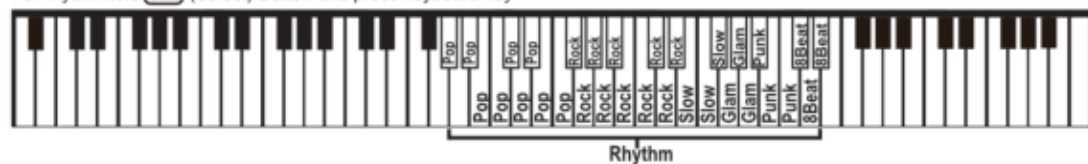

To stop the rhythm accompaniment, press and hold the SELECT button on the control panel while pressing the B0 (Stop) keyboard key. For more Information see **STOP**.

The keyboard area for rhythm selection has multiple assignments. For more information, see **Rhythm Group**.

To change the speed of the drum rhythm, follow the instructions under **Tempo**.

You can also use the rhythms of the rhythm accompaniment as full-fledged auto accompaniment with chord recognition. For more information, see **Playing with auto accompaniment**.

Demo

To start the demo function, press and hold the SELECT button on the control panel and press a key in the keyboard range C1-F#3 (Demo).

To stop the demo song playback, press and hold the SELECT button on the control panel and press the B0 (Stop) keyboard key.

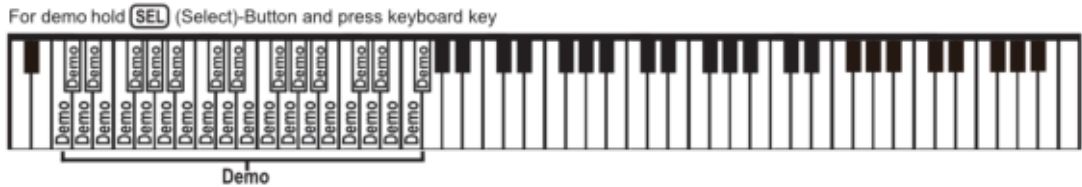

Demo Loop

To play the demo songs in a continuous playback, press and hold the SELECT button on the control panel and press the keyboard key E6 (Demo Loop).

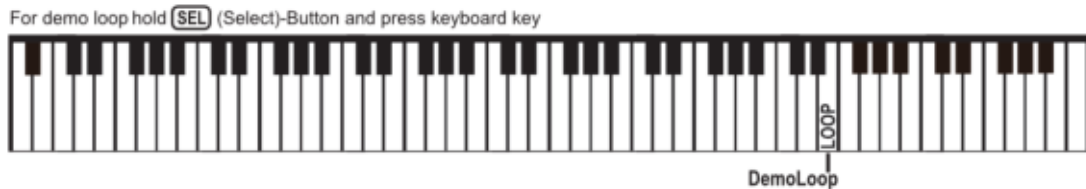

STOP

To stop rthm, demo and record playback, press and hold the SELECT button on the control panel and press the B0 keyboard key (Stop).

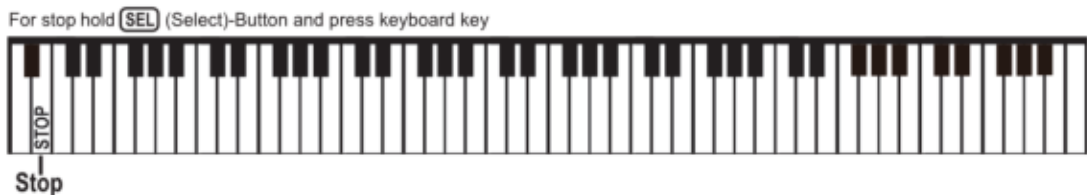

Functions of the SET key (SETTING)

Touch sensitivity

Touch sensitivity, which enables dynamic piano playing, can be disabled if necessary by pressing and holding the SETTING button on the control panel and pressing the keyboard key C4 (Touch On/Off). To re-enable touch sensitivity, press and hold the SETTING button on the control panel and press the C4 keyboard key again.

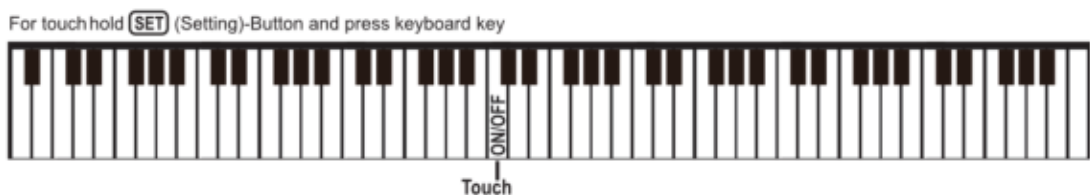

Effects

The piano can apply various effects to the selected timbre. These are vibrato, reverb and sustain (compare right foot pedal). To activate or deactivate the effects, press and hold the SETTING button on the control panel and simultaneously press one of the keys in the keyboard range D4-E4 (Vibrato, Reverb, Sustain).

For effect hold **SET** (Setting)-Button and press keyboard key

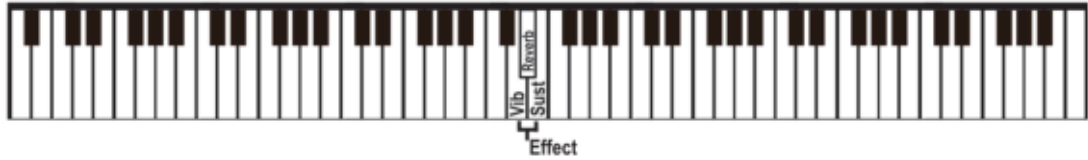

Metronome

To start the metronome function, press and hold the SETTING button on the control panel and press the G1 (Metro) keyboard key.

To stop the metronome function, press and hold the SETTING button on the control panel and press the G1 keyboard key again.

For metronome hold **SET** (Setting)-Button and press keyboard key



Tempo

To change the speed of the metronome or a rhythm accompaniment, press and hold the SETTING key on the control panel and select the desired speed via the keyboard range G2-A2 (+,-). Press G2 several times to increase the speed or A2 several times to decrease the speed.

For tempo hold **SET** (Setting)-Button and press keyboard key



Beat

To change the time signature of the metronome, press and hold the SETTING button on the control panel and simultaneously press one of the keys in the keyboard range A1-D2 (1/4, 2/4, 3/4, 4/4).

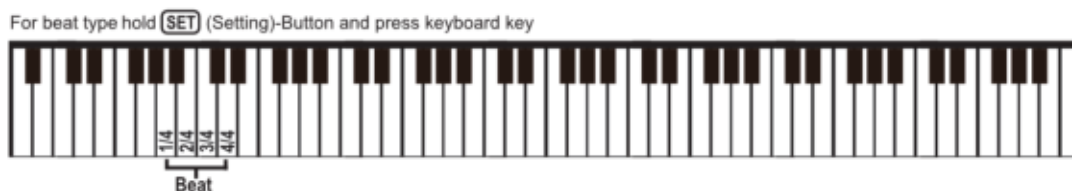

Recording function

The recording function is controlled by pressing and holding the SETTING key on the control panel and pressing a key in the keyboard range B0-F1. Two separate recordings can be saved or played back. It is also possible to play back both recordings simultaneously.

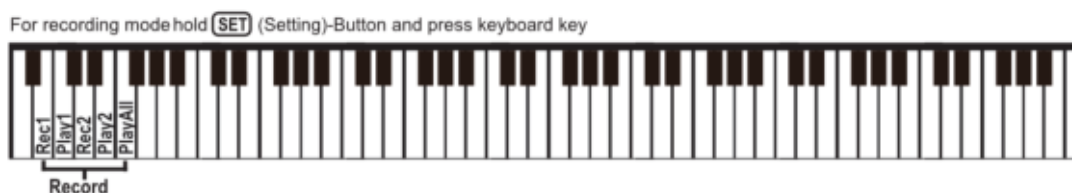

Example:

Press and hold the SETTING key on the control panel and simultaneously press the B0 keyboard key to start the recording (Rec1). Press and hold the SETTING key on the control panel and simultaneously press the B0 keyboard key again, to end the exposure. Press and hold the SETTING key on the control panel and simultaneously press the keyboard key C1 (Play1) to start the recording you have made. Press and hold the SETTING key on the control panel and the C1 key again to stop playback.

When the instrument is turned off, the recording memories are erased.

Rhythm Group

The instrument offers a large number of different rhythms. For this reason, the keyboard area for rhythm selection has multiple assignments. Press and hold the SETTING key on the control panel and use the keyboard range C5-F5 (1,2,3,4) to select one of the four groups assigned with rhythms.

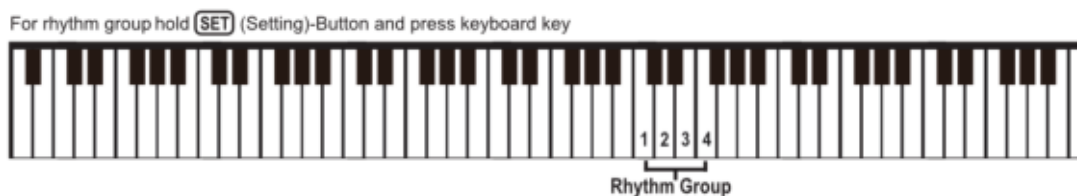





MP3 player



ATTENTION:

We recommend the use of MINI USB sticks. Please note that standard USB sticks can be damaged when the keyboard cover of the instrument is pushed shut.

Insert a USB stick into the USB socket of the MP3 player unit. Start or stop playback with the **Play** key . Switch to the next or previous title by briefly pressing  or . Adjust the playback volume of the MP3 file by holding down  or .

Analogously, you can also use the USB socket on the back of the device.

Product specifications

Keyboard	88 velocity sensitive hammer keys
Touch sensitivity	On, Off
Max. Polyphony	128
Voices	8
Demo	31
Pedals	3 (Soft, Sostenuto, Sustain)
Connections	Aux-In, Aux-Out, USB to Host, USB to Device, 2x headphones (6.35mm stereo), pedal, power adapter
Speaker power	2x25W
Dimensions (WxDxH in mm)	1370x410x980 (incl. music stand)
Weight (kg)	45
Power supply unit	12V, 3000mA, + inside

Trouble Shooting

If a malfunction occurs, please check the following error sources.

Error	Cause	Solution
The piano does not turn on	<ol style="list-style-type: none"> 1.The power cord is not plugged in 2.The socket has no power 	<ol style="list-style-type: none"> 1.Plug in the power cord correctly 2.Use another socket
The piano does not emit sound from the speakers	<ol style="list-style-type: none"> 1.The volume is set to the lowest value 2.A headphone (adapter) is plugged into the headphone jack 3.The power cord is not plugged in 	<ol style="list-style-type: none"> 1.Increase the volume setting 2.Remove the headphone (adapter) from the headphone jack. 3.Plug the instrument into a power outlet.
The left keyboard area does not respond.	The chord recognition is activated.	Deactivate the chord detection as explained under "Accompaniment automatic of rhythm detection".
The instrument emits noise	<ol style="list-style-type: none"> 1.There are devices with interference properties (freezer, washing machine or similar) in the immediate vicinity. 2.Objects on or near the instrument resonate with 3.Screw connections on the instrument have loosened due to the vibrations or dry ambient air. 4.The noise only occurs when using headphones 	<ol style="list-style-type: none"> 1. Remove the piano from the vicinity of other electrical appliances (especially those with motors). 2.Remove resonating objects from the environment of the piano 3.Tighten all screws that can be reached from the outside. 4.Clean the headphone plug or replace the headphone.

WEEE Declaration (Waste of Electrical and Electronic Equipment)

Your product has been designed and manufactured using high quality materials and components that are recyclable and reusable. This symbol means that electrical and electronic equipment must be disposed of separately from household waste at the end of their service life.

Please dispose of this device at your local municipal collection point or at the recycling center.

Please help protect the environment in which we all live.

All specifications and appearance are subject to change without notice. All information was correct at the time of printing. Musikhaus Kirstein GmbH assumes no responsibility for the accuracy or completeness of the descriptions, photos or statements contained in this manual. Printed colors and specifications may vary slightly from the product. Products of Musikhaus Kirstein GmbH are distributed only through authorized dealers. Distributors and dealers are not representatives of Musikhaus Kirstein GmbH and are not authorized to legally bind Musikhaus Kirstein GmbH in any way, whether expressly or through conclusive action.

 **KIRSTEIN.de**

Musikhaus Kirstein GmbH

Bernbeurener Str. 11

86956 Schongau – Germany

Phone: 0049-8861-909494-0

Fax: 0049-8861-909494-19

