

FUNKEY

Funkey 61 Edition / Edition Pro



User manual

00038124/00038126/00038127/00038128
Version 05/2020

WEEE declaration

Your product is designed and manufactured with materials and components of high quality, which are recyclable and can be reused. The symbol means that your product should be disposed of separately from household waste when it reaches its end of life. Please dispose of this equipment at your local collection point or recycling center. Please help to protect the environment in which we all live.

All specifications and appearances are subject to change without notice. All information was correct at time of printing. Musikhaus Kirstein GmbH does not guarantee for the accuracy or completeness of any description, photograph or statement contained in this manual. Printed colors and specifications may vary slightly from product. Products from Musikhaus Kirstein GmbH are only sold through authorized dealer. Distributors and dealers are not agents of Musikhaus Kirstein GmbH and have no authority to bind Musikhaus Kirstein GmbH legally in any way. This manual is protected by copyright. Any copying or reprint, even in excerpts, is only allowed with written consent of Musikhaus Kirstein GmbH. The same applies to reproduction or copying of images, even in altered form.



 musikhaus
KIRSTEIN.de

Musikhaus Kirstein GmbH
Bernbeurerstr. 11
86956 Schongau
Germany

Telefon/Phone: 0049-8861-909494-0
Telefax/Fax: 0049-8861-909494-19

www.kirstein.de

Caution

The following requirements shall be observed to avoid hurting yourself Or anybody else as well as damaging of peripheral devices. The intensions will include (but not limited to) the followings:

Cautions

AC/DC adapter:

- Please use specified AC/DC Adapter, otherwise fault adapter may cause damage of your electronic organ.
- Do not place AC adapter or power cord near heating source such as central heating or heat radiator.
- Do not overbend wire and place heavy matters on wire or wind wire with other matters to avoid damaging wire.
- Regularly check power plug and clean surface dirt. Do not pull out power plug with wet hand.

Do not open the casing of electronic organ:

- Do not open the casing of electronic organ and try to disassemble any part of it, nor make any change to it. Should any abnormal function occur in use, please stop operating it immediately and send it for repair by qualified servicemen.

Location of placing electronic organ:

- Do not place the electronic organ in an environment of dusty, vibrating, low or high temperature (such as exposed to direct sunshine, near central heat or in the car exposed under sunshine) to avoid damaging appearance or internal part.
- Do not put the electronic organ in an unstable place to avoid falling. Do not put any vessel holding liquid on the electronic organ to avoid liquid flowing in it and impairing internal part.

Maintenance:

- To clean the body of the electronic organ, wipe it with dry soft cloth. Do not use paint, dope, organic solvent or chemically impregnated cloth.

Connection of peripheral device:

- In order to prevent speaker from damaging, please adjust the volume of peripheral device to the lowest and after music is gradually played, adjust to appropriate volume.

Caution in operation:

- Do not perform the organ with the loudest or uncomfortable volume to avoid decline in hearing.
- Do not place heavy matters on the electronic organ, nor press keyboard, switch and socket With heavy force.
- The package shall be opened by adult to avoid the danger of suffocating infant or children. Please properly store or dispose the plastic package after unpacking. The matters contained are not suitable for using by the children under 3 years old.

Notice

- Specifications are subject to change without notice.
- Should any description of product function be not specified in detail or some typing error occur, Please forgive us.
- This company retains the right which needs to revise because of the duty and finally interp retention.

Appendix V. Technical specifications

■ Carried Standard

- GB8898-2011 GB17625. 1-2012
- GB13837-2012

■ Display

- LED display/LCD display

■ Tone

- 300 kinds of tones

■ Rhythm

- 300 kinds of world well-chosen auto accompaniment

■ Demo

- 40 demo songs

■ Effect control

- Sustain, vibrato, double voice, keyboard split, transpose, beat, Intro/ending, drum

■ Record and program

- Record, play, program

■ Other function

- Panel percussion/MP3 function

■ Accompaniment control

- Start/stop, sync, fill in, tempo

■ Chord control

- Single chord, finger chord, chord clear, chord volume

■ Intelligent teaching

- Teaching function

■ Other control

- Power switch, master volume control, rhythm volume control

■ External jack

- DC12V power input, headphone output, MIDI output, microphone input, MP3 jack

■ Diapason

- C2~C7

■ Intonation

- ≤ 3 cents

■ Format

- 948x315x105 (mm)

■ Net weight

- 5.0Kg

■ Power adapter

- AC220V, DC 9V 500mA

■ DC input

- DC 9V

■ Output power

- 6W \times 2

■ Quiescent current

- 150mA

■ Random accessories

- Adapter, song sheet holder, manual

Number	The name of song	Number	The name of song	Number	The name of song
00	Turkey March	14	Chong Erfei	28	In rain
01	Red River Valley	15	Minuet in G major	29	long time ago
02	American Patrol	16	Spanish Matador	30	Magic Flute Overture
03	Susanna	17	Serenade - Haydn	31	Silent Night
04	Mozart Piano Sinata	18	Yankee Doodle	32	Hungary Dance
05	Mariage d'amour	19	Waltz	33	Western is gone
06	Waterside Adi Lina	20	Minuet	34	Fountain
07	Smile Polka	21	Rain Melody	35	Mary had a little lamb
08	Jingle Beus	22	Frosty	36	Music Box Dance
09	Lardesik March	23	Old French	37	Four Seasons
10	Mozart No.40	24	Blue Danube	38	Concerto Of Love
11	Clapping song	25	A small brown bottle	39	Destiny
12	Fur Elise	26	Hawthorn		
13	Katyusha	27	River Of Babylon		

Appendix IV.Faults and exclusion

Faults	Possible causes/resolution
When you turn on the keyboard, it will be some noise.	Do not worry,it's the normal phenomenon.
When turn on the power swith, play with the keyboard,it's no voice at all.	Check the main volume button if it is in the proper position and headphone jack was connected with other equipments,so that the built-in speaker system cut off.
Distortion sound or interruption,or evencan not work at all.	Use unqualified power adapter or the electric power of the battery is not enough,pls use the power adapter that equipped with this keyboard or replace the batteries.
The note and the timbre of the note has the slight difference in a tone.	This is normal phenomenon caused by different tone sample diapason.
When use the function of sustain, some tone has long sustain but some has short sustain.	This is normal phenomenon because the best length of the sustain of the different tone has been set.
The main voluem and the accompaniment volume is abnormal.	Check the main volume and the accompaniment volume are set at the proper position.
In sync function,but the auto accompaniment does not work.	Check whether single chord or finger chord were set.At this satuation,play 19keys in the left of the keyboard.
When use the external adapter, put on the power switch,no sound, LCD or LED no display.	Check whether power socket has the electricity, and the power adapter was well insertted,the power jack has the poor contact or the voltage is not enough.
When use the batteries,the keyboard is no sound when put on LED/LCD has no display.	Check whether batteries polarity was correct and the batteries has run out.
The pitch of nore is not correct.	Check whether the parameter of transposes is "00".
When use the mobilphone, the	Mobilphone can disturb the keyboard,to avoid the noise,pls turn off the mobil or use it in far place.

Contents

I. panel control and external jack	1-2
1.panel control	1
LED Graphic display	2
LCD Graphic display	2
2.external jack	2
II.preparation before performance	2-3
Power requirements	2
1.use power adapter	2
2.use battery.....	3
Appendix jack	3
1.use headphone	3
2.MIDI function	3
3.MP3 function	3
4.External microphone	3
III. Basic method of operation	4-7
Basic operations	4
1. turn on the power	4
2. master volume control	4
Tone	4
1. tone selection	4
Effects and control	4-6
1.sustain function	4
2.vibrato function.....	4
3.double voice	5
4.keyboard split	5
5.drum	5
6.transpose function	5
7.beat	5
8.tempo	5
9.panel percussion	6
Rhythm and rhythm related function	6-7
1.rhythm select	6
2.start/stop	6
3.sync function	6
4.fill in function	6
5.intro/ending	7
6.rhythm volume	7
Chord	7
1.single chord	7
2.finger chord	7
3.chord clear	7
4.chord volume	7
Recprd function	8
Teaching function	8
Sleep function	8
Appendix I.tone list	9
Appendix II.rhythm list	10
Appendix III.demo songs chart	11
Appendix IV.faults and exclusion	11
Appendix V.technical specifications	12

I.Panel control and external jack

Panel control

LED display

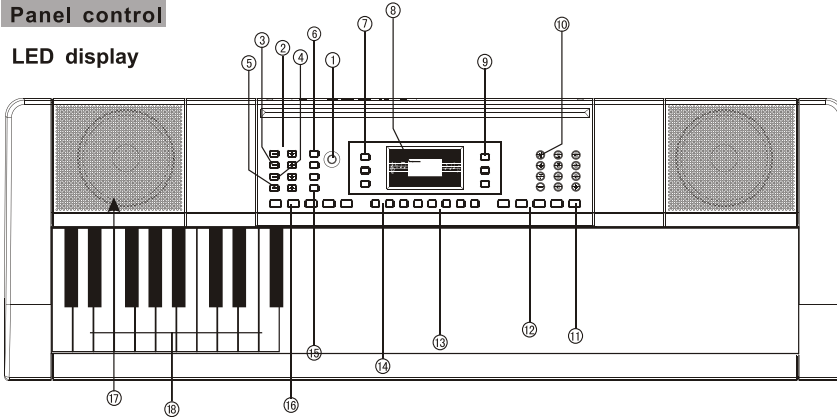

- 1. Power switch
- 2. Master volume+, -
- 3. Rhythm volume+, -
- 4. Chord volume+, -
- 5. Tempo+, -
- 6. Play/record/program
- 7. Single chord/finger chord /chord clear
- 8. LED display
- 9. Demo/rhythm/tone
- 10. Number0-9/+, -
- 11. Drum
- 12. Sustain/vibrato/double voice /keyboard split
- 13. Panel percussion/MP3 function
- 14. Transpose+, -
- 15. beat
- 16. Sync/start/stop/fill in/ intro/ending/teaching
- 17. Speaker
- 18. chord region

LCD display

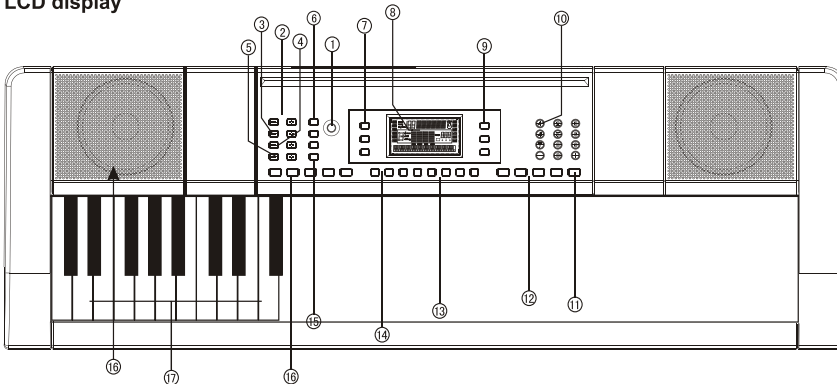

- 1. Power switch
- 2. Master volume+, -
- 3. Rhythm volume+, -
- 4. Chord volume+, -
- 5. Tempo+, -
- 6. Play/record/program
- 7. Single chord/finger chord /chord clear
- 8. LCD display
- 9. Demo/rhythm/tone
- 10. Number0-9/+, -
- 11. Drum
- 12. Sustain/vibrato/double voice /keyboard split
- 13. Panel percussion/MP3 function
- 14. Transpose+, -
- 15. beat
- 16. Sync/start/stop/fill in/ intro/ending/teaching
- 17. Speaker
- 18. chord region

NO.	Name of rhythm	NO.	Name of rhythm	NO.	Name of rhythm	NO.	Name of rhythm	NO.	Name of rhythm
00	Soul 1	60	Swing 4	120	Waltz 2	180	Japanese Folk Music	240	CountryDance2
01	Soul 2	61	Swing 5	121	Waltz 3	181	Trip Hop1	241	CountryDance3
02	Soul 3	62	Swing 6	122	Waltz 4	182	Trip Hop2	242	World Fusion
03	Soul 4	63	Baiao	123	Jazz Waltz 1	183	Chamber pop1	243	Chinese traditional1
04	Soul 5	64	Bolero	124	Jazz Waltz 2	184	Chamber pop12	244	Chinese traditional2
05	Soul 6	65	Bossanova 1	125	Jazz Waltz 3	185	PopSwing1	245	Chinese traditional3
06	Soul 7	66	Bossanova 2	126	Country Waltz 1	186	PopSwing2	246	Thailand Rhythm
07	Soul 8	67	Bossanova 3	127	Country Waltz 2	187	PopSwing3	247	ModernWaltz1
08	Slow Soul 1	68	Bossanova 4	128	JazzSoul1	188	PopSwing4	248	ModernWaltz2
09	Slow Soul 2	69	Bossanova 5	129	JazzSoul2	189	PopSwing5	249	ModernWaltz3
10	Slow Soul 3	70	Calyпсо	130	JazzSoul3	190	PopSwing6	250	ModernWaltz4
11	Slow Soul 4	71	Habanera	131	JazzSoul4	191	Celtic Pop	251	Britpopwaltz1
12	Slow Soul 5	72	Reggae 1	132	JazzSoul5	192	Hawaiian Pop	252	Britpopwaltz2
13	Funkey soul 1	73	Reggae 2	133	JazzSoul6	193	SoftBossanova1	253	Britpopwaltz3
14	Funkey soul 2	74	Jorpo	134	JazzSoul7	194	SoftBossanova2	254	Contemporary Waltz1
15	Funkey soul 3	75	Tango 1	135	JazzSoul8	195	SoftBossanova3	255	Contemporary Waltz2
16	Funkey soul 4	76	Tango 2	136	Light Beat 1	196	SoftBossanova4	256	ModernSoul1
17	Funkey soul 5	77	Tango 3	137	Light Beat 2	197	SoftBossanova5	257	ModernSoul2
18	Funkey soul 6	78	Manbo 1	138	Light Beat 3	198	Mento	258	ModernSoul3
19	Funkey soul 7	79	Manbo 2	139	Light Beat 4	199	Shima Uta	259	ModernSoul4
20	Funkey soul 8	80	Rhumba 1	140	Light Beat 5	200	Reggae-Pop1	260	ModernSoul5
21	West Coast	81	Rhumba 2	141	SoulPsychedelic 1	201	Reggae-Pop2	261	ModernSoul6
22	Euro Soul	82	Rhumba 3	142	SoulPsychedelic 2	202	European Traditions	262	ModernSoul7
23	16 AOR 1	83	Rhumba 4	143	SoulPsychedelic 3	203	TangoPop1	263	ModernSoul8
24	16 AOR 2	84	Rhumba 5	144	SoulPsychedelic 4	204	TangoPop2	264	Classical Soul 1
25	16 Beat 1	85	Bequine	145	SoulPsychedelic 5	205	TangoPop3	265	Classical Soul 2
26	16 Beat 2	86	Salsa	146	SoulPsychedelic 6	206	Rhythm Mambo 1	266	Classical Soul 3
27	16 Beat 3	87	Merengue 1	147	SoulPsychedelic 7	207	Rhythm Mambo 2	267	Classical Soul 4
28	16 Ballad 1	88	Merengue 2	148	SoulPsychedelic 8	208	BritRhumba 1	268	Classical Soul 5
29	16 Ballad 2	89	Valentao	149	Goth Psychedelic	209	BritRhumba 2	269	Contemporary R&b1
30	Pop Dance 1	90	Plena	150	Psychedelic swing	210	BritRhumba 3	270	Contemporary R&b2
31	Pop Dance 2	91	Lambada	151	Folkrock1	211	BritRhumba 4	271	Contemporary R&b3
32	Pop Dance 3	92	Bachata 1	152	Folkrock2	212	BritRhumba 5	272	Contemporary R&b4
33	Shuffle 1	93	Bachata 2	153	New century1	213	SoulBequine	273	Contemporary R&b5
34	Shuffle 2	94	Bachata 3	154	New century2	214	Chamber pop	274	Contemporary R&b6
35	8 Shuffle	95	Samba 1	155	New century3	215	Neo-Merengue1	275	Contemporary R&b7
36	Hard Rock	96	Samba 2	156	16 Pop 1	216	Neo-Merengue2	276	Contemporary R&b8
37	Slow Rock 1	97	Pop Samba 1	157	16 Pop 2	217	Big Beat	277	Deep Funk
38	Slow Rock 2	98	Pop Samba 2	158	Modern dance1	218	PlenaBeat	278	European Jazz
39	Pop Classic	99	Pop Samba 3	159	Modern dance2	219	Downtempo	279	70' Rock
40	Blues	100	Jazz Samba	160	Modern dance3	220	ElectricBachata 1	280	80' Rock
41	Twist	101	March 1	161	Modern dance4	221	ElectricBachata 2	281	16 SoftRock 1
42	Hard 3 Beat	102	March 2	162	Modern dance5	222	ElectricBachata 3	282	16 SoftRock 2
43	Love Ballad 1	103	March 3	163	8 Post Rock	223	FolkSamba1	283	16 SoftRock 3
44	Love Ballad 2	104	March 4	164	ClassicRock	224	FolkSamba2	284	
45	Love Ballad 3	105	Polkal 1	165	JazzRock1	225	Jump Samba 1	285	16 BalladRock
46	Love Ballad 4	106	Polkal 2	166	JazzRock2	226	Jump Samba 2	286	Afro Dance 1
47	Euro Beat	107	Polkal 3	167	Traditional Pop	227	Jump Samba 3	287	Afro Dance 2
48	House 1	108	C&W 1	168	Country Blues	228	Afro Samba	288	Afro Dance 3
49	House 2	109	C&W 2	169	Indian Pop	229	Rock March1	289	JazzShuffle1
50	Swing Beat	110	Bluegrass	170	Hard 3 Rock	230	Rock March2	290	JazzShuffle2
51	8 Ballad	111	Country 1	171	Classical ballad1	231	Rock March3	291	8 JazzShuffle
52	Step	112	Country 2	172	Classical ballad2	232	Rock March4	292	Heavy metal rock
53	Big Band 1	113	Country 3	173	Classical ballad3	233	PolkaBlues1	293	RockDance1
54	Big Band 2	114	Middle East	174	Classical ballad4	234	PolkaBlues2	294	RockDance2
55	Conbmo 1	115	China 1	175	Light Ballad	235	PolkaBlues3	295	Middle East Pop
56	Conbmo 2	116	China 2	176	Deep House	236	CountryRock1	296	Soul Blues
57	Swing 1	117	China 3	177	Hard House	237	CountryRock2	297	Glam Rock
58	Swing 2	118	Thailand	178	House dance	238	Jazz Blues	298	Hard House
59	Swing 3	119	Waltz 1	179	8 Pop	239	CountryDance1	299	Light Ballad

NO.	Name of tone	NO.	Name of tone	NO.	Name of tone	NO.	Name of tone
00	Acoustic Grand Piano	60	French Horn	120	Guitar Fret Noise	180	Bright Violin
01	Bright Acoustic Piano	61	Brass Section	121	Breath Noise	181	Stringed violin
02	Electric Grand Piano	62	Synth Brass 1	122	Seashore	182	Trill violin
03	Honky-tonk Piano	63	Synth Brass 2	123	Bird Tweet	183	Electronic violin
04	Rhodes Piano	64	Soprano Sax	124	Telephone Ring	184	Large violin
05	Chorused Piano	65	Alto Sax	125	Helicopter	185	rhythm Orchestra
06	Harpsichord	66	Tenor Sax	126	Applause	186	Pizzicato Violin
07	Clavichord	67	Baritone Sax	127	Gunshot	187	Pizzicato Ensemble 1
08	Celesta	68	Oboe	128	Percussion	188	Pizzicato Ensemble 2
09	Glockenspiel	69	English Horn	129	Rhythm electric Piano	189	Percussion band
10	Music box	70	Bassoon	130	Baritone Xylophone	190	Baritone Synth Contrabass
11	Vibraphone	71	Clarinet	131	Clean Piano	191	Bass Flute
12	Marimba	72	Piccolo	132	Bright Dulcimer	192	Distortion Contrabass
13	Xylophone	73	Flute	133	Rhythm Grand Piano	193	Contrabass Lead
14	Tubular Bells	74	Recorder	134	Traditional Piano	194	Violin Lead
15	Dulcimer	75	Pan Flute	135	Aluminium jean	195	Cello Lead
16	Hammond Organ	76	Bottle Blow	136	Rock Grand Piano	196	Pizzicato rhythm
17	Percussive Organ	77	Shakuhachi	137	Electronic organ	197	high Harp
18	Rock Organ	78	Whistle	138	Psychedelic electronic	198	Harp ensemble
19	Church Organ	79	Ocarina	139	Water jean	199	Synth Harp
20	Reed Organ	80	Lead 1 (square)	140	Bright Guitar	200	Baritone Trumpet
21	Accordion	81	Lead 2 (sawtooth)	141	Orchestra piccolo	201	Trumpet ensemble
22	Harmonica	82	Lead 3 (caliopee lead)	142	Heavy metal guitar	202	rhythm Trumpet
23	Tango Accordion	83	Lead 4 (chiff lead)	143	Crystal guitar	203	high Trumpet
24	Acoustic Guitar (nylon)	84	Lead 5 (charang)	144	Queer electric Piano	204	Synth Trumpet
25	Acoustic Guitar (steel)	85	Lead 6 (voice)	145	Bright bass	205	Baritone Trombone
26	Electric Guitar (jazz)	86	Lead 7 (fifths)	146	Rock Electric Bass	206	Trombone ensemble
27	Electric Guitar (clean)	87	Lead 8 (bass+lead)	147	Rhythm Electric Bass	207	rhythm Trombone
28	Electric Guitar (muted)	88	Pad 1 (new age)	148	Psychedelic Bass	208	rhythm Trombone
29	Overdriven Guitar	89	Pad 2 (warm)	149	Heavy metal bass	209	baritone Trombone
30	Distortion Guitar	90	Pad 3 (polysynth)	150	Magic electronic	210	Synth Trombone
31	Guitar Harmonics	91	Pad 4 (choir)	151	Bright violin	211	Violin French Horn
32	Acoustic Bass	92	Pad 5 (bowed)	152	Atonic violin	212	French Horn ensemble
33	Electric Bass(finger)	93	Pad 6 (metallic)	153	Heavy bass orchestra	213	Electronic French Horn
34	Electric Bass (pick)	94	Pad 7 (halo)	154	Synth clarinet	214	Synth French Horn
35	Fretless Bass	95	Pad 8 (sweep)	155	Interactive Lead	215	Psychedelic Synth Brass
36	Slap Bass 1	96	FX 1 (rain)	156	For the keyboard	216	Distortion Synth Brass
37	Slap Bass 2	97	FX 2 (soundtrack)	157	Bagpipes	217	Vibraphone Synth Brass
38	Synth Bass 1	98	FX 3 (crystal)	158	Suona	218	Synth Muted Trumpet
39	Synth Bass 2	99	FX 4 (atmosphere)	159	Pipa	219	Rock Synth Brass
40	Violin	100	FX 5 (brightness)	160	Church Piano	220	Soprano Sax ensemble
41	Viola	101	FX 6 (goblins)	161	Church electric Piano	221	rhythm Soprano Sax
42	Cello	102	FX 7 (echoes)	162	Synth Piano	222	Synth Soprano Sax
43	Contrabass	103	FX 8 (sci-fi)	163	Baritone Piano	223	National Sax
44	Tremolo Strings	104	Sitar	164	Piano PAD	224	Metal Sax
45	Pizzicato Strings	105	Banjo	165	String Piano	225	Baritone Sax ensemble
46	Orchestral Harp	106	Shamisen	166	Metal Piano	226	Crystal Sax
47	Timpani	107	Koto	167	Light rhythm Piano	227	Soft Baritone Sax
48	String Ensemble 1	108	Kalimba	168	electric Piano Pad	228	Synth Baritone Sax
49	String Ensemble 2	109	Bagpipe	169	Classical piano	229	Heavy metal Sax
50	Synth Strings 1	110	Fiddle	170	Guitar organ	230	Church Oboe
51	Synth Strings 2	111	Shanai	171	An electric guitar	231	Bass Oboe
52	Choir Aahs	112	Tinkle Bell	172	synthesis Nylon Guitar	232	Oboe ensemble
53	Voice Oohs	113	Agogo	173	Synthetic electronic guitar	233	Bright Oboe
54	Synth Voice	114	Steel Drums	174	Bright clean Guitar	234	distortio oboe
55	Orchestra Hit	115	Woodblock	175	Orchestra Guitar	235	English Horn ensemble
56	Trumpet	116	Taiko Drum	176	Psychedelic Guitar	236	Pizzicato English Horn
57	Trombone	117	Melodic Tom	177	Bright organ	237	Diplophonia English Horn
58	Tuba	118	Synth Drum	178	Pick organ	238	Bright English Horn
59	Muted Trumpet	119	Reverse Cymbal	179	Synth accordion	239	Synth English Horn
240	Psychedelic Synth Lead						
241	Vibraphone Synth Lead						
242	Marimba Synth Lead						
243	Metal FX						
244	Electronic FX						
245	Electronic String Ensemble						
246	Wind FX						
247	Clarinet FX						
248	Organ FX						
249	Crystal FX						
250	Synth Shamisen						
251	Electronic Shamisen						
252	Bright Sitar						
253	Whistle Accord.						
254	rhythm Nation						
255	Bright Koto						
256	Koto Lead						
257	Diplophonia Koto						
258	Baritone Koto						
259	Synth Koto						
260	Environmental Lead						
261	Metal Lead						
262	Orchestra Lead						
263	Glockenspiel Lead						
264	Bass Lead						
265	Fifths Lead						
266	Wind Lead						
267	Atmosphere Lead						
268	Sharp Lead						
269	Bright Lead						
270	East Nation Pad						
271	Atmosphere Pad						
272	Electric bass Pad						
273	electric Piano Pad						
274	Clean Guitar Pad						
275	Western Pad						
276	Sci-fi Pad						
277	Metal Sci-fi Pad						
278	Clarinet Pad						
279	Electronic dance Pad						
280	Double Kalimba						
281	Bright Kalimba						
282	Crystal Kalimba						
283	Synth Kalimba						
284	Electronic Bagpipe						
285	Wind Bagpipe						
286	high Bagpipe						
287	Bright Bagpipe						
288	Orchestra Bagpipe						
289	Baritone Bagpipe						
290	Environmental Shanai						
291	Baritone Shanai						
292	Tenor Shanai						
293	high Shanai						
294	Synth Shanai						
295	Bright Steel Drums						
296	Steel Drums Lead						
297	Lyric Steel Drums						
298	Orchestra Steel Drums						
299	Synth Steel Drums						

II.Preparation before performance

LCD graphic display

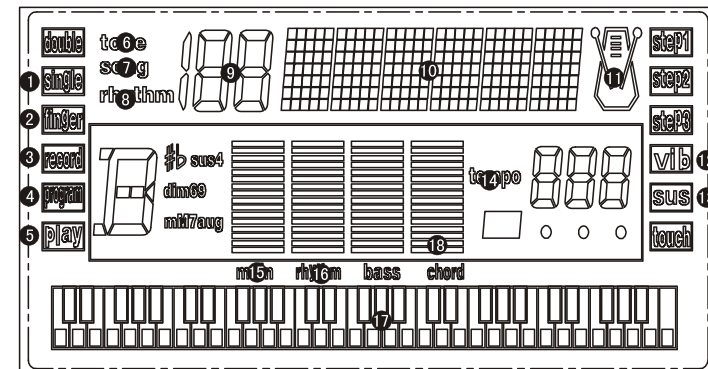

1. Single chord
2. Finger chord
3. Record
4. Program
5. Play
6. Tone
7. Demo
8. Rhythm
9. LCD display
10. Character display area
11. Beat
12. Vibrato
13. Sustain
14. Tempo
15. Master volume
16. Rhythm volume
17. B/W key display
18. Chord volume

External jack

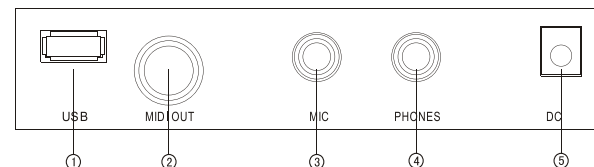

1. USB jack
2. MIDI output
3. Microphone jack
4. Earphone jack
5. DC 9V power input

II.Preparation before performance

Power requirement

1.Using AC/DC power adaptor

Please use the special power adaptor was equipped with this electronic keyboard or the power adaptor with DC 9V out voltage . 500mA out current and cental anode plug. Insert the DC plug of power adaptor into the DC 9V power jack in the rear panel of electronic keyboard, then, insert the other end into Mains socket. (Notice: The input voltage of power adaptor must conform to the voltage of Mains) ,finally turn on power switch and start performance.

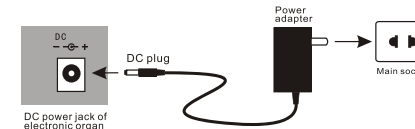

II.Preparation before performance

Caution:When you don't use this electronic keyboard, you should unplug the plug of power adaptor from power socket safely to avoid the parts trouble or other accident for long-term charging

2.Using batteries

Open the battery lid at the bottom of electronic keyboard and load 6pcs AA size batteries , ensure the polarity of the batteries should conform to the anode and cathode direction of batteries marked on battery lid. Cover the battery lid after the installation.

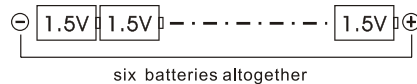

Caution : Don't use different kinds of batteries at the same time and mix new and old batteries for use.The volume will go down and the timbre will be bad if the electrical quantity of batteries isn't enough,you have to replace the new batteries now.Please take out the batteries as to avoid possible damage caused by the batteries leakage if you don't use the electronic keyboard for long time.

Accessories ports

1.Headphone use

Insert headphone plug into [HEADPHONES] port in back of electronic keyboard. Now, the internal speaker system of electronic keyboard cuts off automatically,Using headphone doesn't interfere with others during performance,it is special for personal monitor and exercising at night.

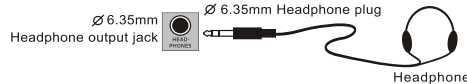

2.MIDI output

By linking MIDI line,you can connect MIDI OUT jack to another MIDI compatible device to transfer MIDI data to the electronic keyboard.When play a note,the corresponding MIDI data will be transferred.You may also control other MIDI devices by transferring program changing data.

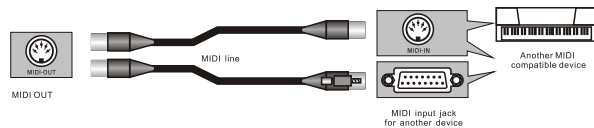

Notice: the additional device in above, you need to purchase by yourself ,not include by the keyboard,pls understand.

3.MP3 function

Mp3 jack: the keyboard support USB play.you may use the usb jack to play Mp3 songs. to change the button as follow can adjust the Mp3 function.

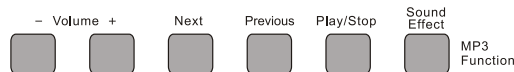

4.Use of microphone

Insert the microphone can playing accompaniment.

III.Basic operation method

4.chord volume

The default value of the chord volume is "07",and you can adjust 9 levels(0-9) of the chord volume by press the CHORD VOLUME "+/-"button .By the way,the LED or LCD display has the corresponding displaying when you adjust. The system will return to the default chord volume if you press CHORD VOLUME "+/-" at the same time .



Record function

1.Press the "record" button to start the recording,at this time press any key can record in the keyboard.The max not can be record is 110 for this keyboard.When the recording is full ,the display will show you "full" that you can not record any more. At the recording status,press any key can clear the music for last time to start a new one.



2.Press "play" button,can play the recording music.



3.Press "program" button to start programming.to press 8 kinds of panel percussion or keyboard to program a rhythm.This edited rhythm can record 32 pcs of percussion sound at the most.Press the "play" button to play the rhythm to become a new rhythm . And to press "+/-" to get the perfect effects. Press this button will be clear last memory to start a new programming.



Teach function

Press "teach" button to start teaching function. You must press the key ,the teaching music can play,else,the music will stop.after press this song,you can be repeat it .To press "song" button to choose the song for learning.And press the same button "teach"to withdraw the teaching function .

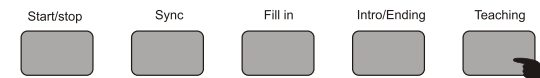

Dormancy function

When you do not press the key more than 5 mins,the keyboard will come to dormancy and to press any key can wake up the keyboard.

III.Basic operation method

5.Intro/ending

Press "Intro/ending" button to start play the prelude, then turn to regular rhythm to continu.During the play of the rhythm, press the "Intro/ending" button,tt to start playing a code for ending.

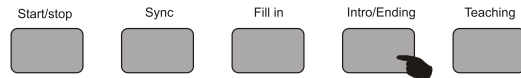

6. Rhythm volume

There are 9 levels for rhythm volume,the default rhythm is 07.to press the "+/-" button to adjust the rhythm volume and the LED or LCD will be show it . Reprress the "+/-" button the keyboard will return back to the default volume for the rhythm.

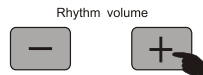

Auto bass chord

Single chord

when the rhythm is start, to press the "single chord" to enter the single chord function. At this time ,in the chord area (1-19key),press any key, can heard different chord rhythm press the "start/stop" to withdraw this function.

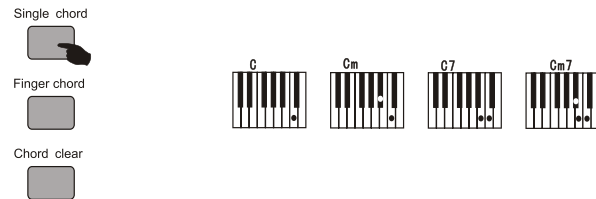

Finger chord

when the rhythm is start, to press the "finger chord" to enter the finger chord function. At this time ,in the chord area (1-19key) ,press any key, can heard different chord rhythm press the "start/stop" to withdraw this function.

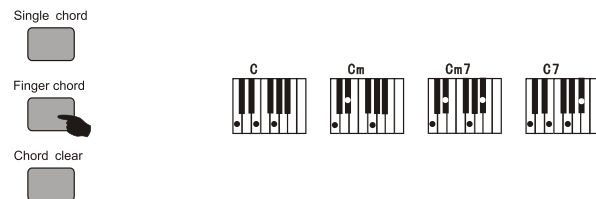

Chord clear

After the chord is start,press the "chord clear" button,the chord rhythm is stop. But the other rhythm is still play.



III.Basic operation method

Basic operation

1.Turn on power

After power adapter was connected or batteries were installed correctly,press "on/off" to start the playing and press "on/off" to close the power of keyboard.



2.Master volume control

This keyboard has 9 levels volume from 00-08.the default value of the main volume is 07, press the "+" and "-", the main volume will increase or decrease correspondly.And press "+" together with "-" the main volume will recover the default value automationally .

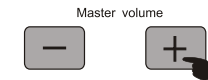

Tone

1.Tone selection

The keyboard has 300 tones,to press "tone" button to start to choosieing another tones,you can press the 0~9 number to change it or press "+/-" to change it.

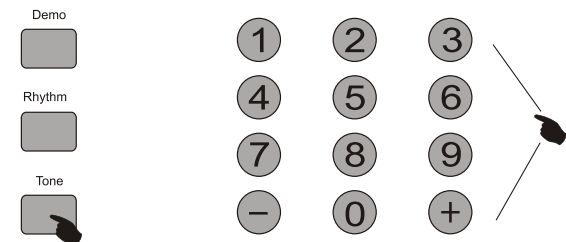

Effects and control

1.Sustain function

Press "sustain" to start sustain function. The prolonged effect note will occur when play with white and black keyboard ,And press "sustain" again to withdraw this function.

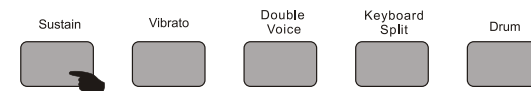

2.Vibrato function

Press "vibrato" to start vibrato function. The trembling effect note will occur when play with white and black keyboard ,And press "vibrato" again to withdraw this function.

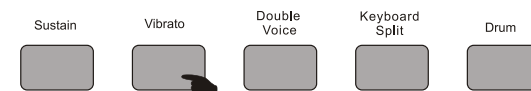

III.Basic operation method

Double voice

Press "dual voice" button to start dual voice function, the performed tone is the tone that composed of two kinds of tone. Now the displaying tone name is the latter tone. The previous tone is the tone before you press this button, press this button again to exist the dual voice function

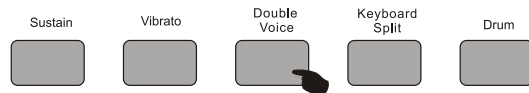

Keyboard split

Press "dual keyboard" to start the dual keyboard function. The keyboard was separate two keyboards from the 24th keys in left. Press the number button can adjust the right key. Repress the "dual keyboard" will withdraw this function.

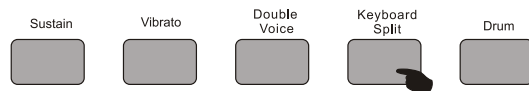

Drum

Press "drum" button, at this time the keyboard turn to the percussion keyboard every key instead of one kind of percussion, repress the "drum" button again, the keyboard turn to regular.

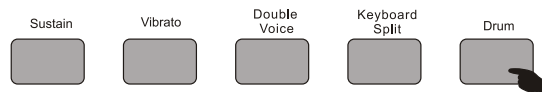

Transpose

Press transpose "+/-" button, the corresponding musical scale can go up or goes down for one note when you play with the black and white keys. you can adjust the musical scale for 6 levels upwards and downwards. Press "+" and "-" together, the system will recover the default keyboard tone automatically.

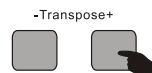

Beat

Press "beat" button to start metronome, the tick-tock beat sound will be occur. There is 4 kinds of metronome to choose, the beat effect will be added when you perform.

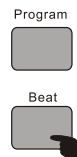

Tempo

Press "+/-" can adjust the tempo of rhythm, beat, demo, the default value of the beat tempo is 120. And the adjustment area is 30-240.



III.Basic operation method

Panel percussion

Press the panel percussion, the total is 6 kinds of percussion. You can insert the percussion if you need.

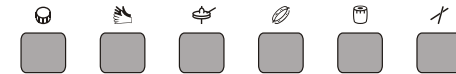

Panel percussion list

Snare drum	Clap	Cymbal	Tambourine	Timpani	Claves

Rhythm and rhythm related function

Rhythm selection

The keyboard has 300 rhythm, and the rhythm list pls following as the appendix of rhythm list. to press "rhythm" button to start to choosing another rhythm, you can press the 0~9 number to change it or press "+/-" to change it. All the LED/LCD will display it.

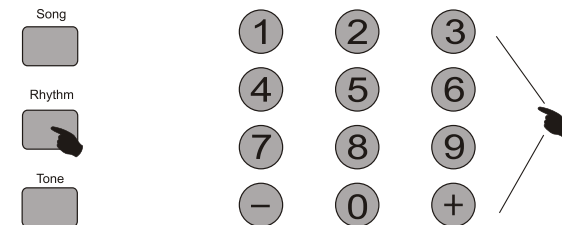

Start/stop function

Press "start/stop" button to play the rhythm, and repress this button to withdraw this function.

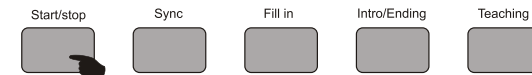

Sync function

Press "sync" button to enter the sync function before the rhythm was played. Now press any key of 19 keys in left hand to start rhythm playback. The beat point shines on the LCD the characters displaying area displays the current tone or rhythm. If the chord function has started, press the corresponding key in 19 keys in chord area, the auto chord starts.



Fill in function

You can fill in a length of interlude to enhance the performance effect if you press "fill in" button during the rhythm playback, then the rhythm will continue to perform based on the original rhythm.



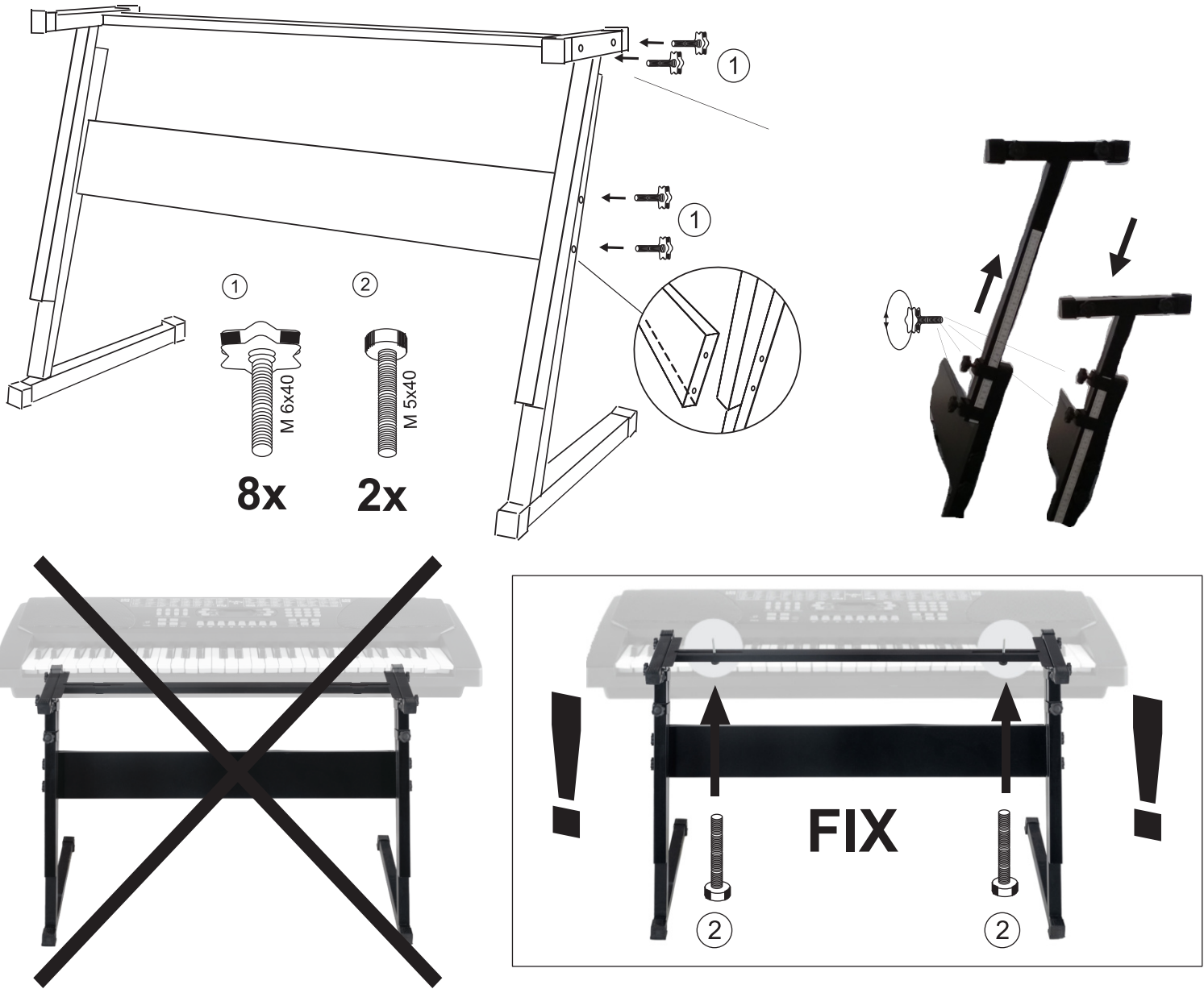

VORSICHTSMASSNAHMEN (BITTE SORGFÄLTIG DURCHLESEN) Kinder sollten beaufsichtigt werden, um sicherzustellen, dass sie dieses Produkt nicht als Spielzeug verwenden. Lassen Sie Kinder niemals unbeaufsichtigt mit dem Verpackungsmaterial spielen. Warnhinweise: Stellen Sie das Produkt stets auf eine geeignete Oberfläche ab, um ein Wackeln oder Umfallen zu verhindern. Vorsichtsmaßnahmen: Um Schäden am Produkt zu vermeiden, stellen Sie es nicht an Plätze mit hohen Temperaturen oder viel Staub, stellen Sie es nicht direkt neben eine Klimaanlage und vermeiden Sie direkte Sonneneinstrahlung. Wenden Sie im Umgang mit dem Produkt keinerlei Gewalt an und stellen Sie keine zu schweren Gegenstände darauf. Ort: Setzen Sie das Produkt nicht den folgenden Bedingungen aus, um Verformungen, Verfärbungen oder größere Schäden zu vermeiden: Direktes Sonnenlicht, extreme Temperatur oder Luftfeuchtigkeit, übermäßig staubiger oder schmutziger Ort, starke Vibrationen oder Stöße. Reinigung: Reinigen Sie das Produkt nur mit einem weichen, trockenen Tuch. Verwenden Sie keine Farbverdünner, Lösungsmittel, Reinigungsflüssigkeiten oder chemisch imprägnierte Wischtücher. Handhabung: Üben Sie keine übermäßige Kraft auf Bedienelemente wie z.B. Schalter, Knöpfe, Tasten aus. Technische Änderungen und Änderungen im Erscheinungsbild sind vorbehalten. Alle Angaben entsprechen dem Stand bei Drucklegung. Für die Richtigkeit und Vollständigkeit der enthaltenen Beschreibungen, Abbildungen und Angaben übernimmt Musikhaus Kirstein GmbH keinerlei Gewähr. Abgebildete Farben und Spezifikationen können geringfügig vom Produkt abweichen. Musikhaus Kirstein GmbH - Produkte sind nur über autorisierte Händler erhältlich. Distributoren und Händler sind keine Handlungsbevollmächtigten von Musikhaus Kirstein GmbH und haben keinerlei Befugnis, die Musikhaus Kirstein GmbH in irgendeiner Weise, sei es ausdrücklich oder durch schlüssiges Handeln, rechtlich zu binden. Diese Bedienungsanleitung ist urheberrechtlich geschützt. Jede Vervielfältigung, bzw. jeder Nachdruck, auch auszugsweise, und jede Wiedergabe der Abbildungen, auch in verändertem Zustand, ist nur mit schriftlicher Zustimmung der Firma Musikhaus Kirstein GmbH gestattet.

PRECAUTIONS (PLEASE READ CAREFULLY) Children should be supervised to ensure that they do not use this product as a toy. Never let children play with the packaging material unsupervised. Warning: Always place the product on a suitable surface to prevent it from wobbling or falling over. Precautions: To avoid damage to the product, do not place it in places with high temperatures or a lot of dust, do not place it directly next to an air conditioner and avoid direct sunlight. Do not use force when handling the product and do not place objects that are too heavy on it. Location Do not expose the product to the following conditions to avoid warping, discoloration, or major damage: direct sunlight, extreme temperature or humidity, excessively dusty or dirty location, strong vibration or shock. Cleaning: Only clean the product with a soft, dry cloth. Do not use paint thinners, solvents, cleaning fluids, or chemically impregnated wipes. Handling: Do not exert excessive force on controls such as Switches, buttons, buttons off. Technical changes and changes in appearance are reserved. All information corresponds to the status at the time of printing. Musikhaus Kirstein GmbH assumes no liability for the correctness and completeness of the descriptions, illustrations and information contained. Shown colors and specifications may differ slightly from the product. Musikhaus Kirstein GmbH - Products are only available through authorized dealers. Distributors and dealers are not authorized representatives of Musikhaus Kirstein GmbH and have no authority to bind Musikhaus Kirstein GmbH legally in any way, be it expressly or through coherent action. This manual is protected by copyright. Any duplication or reprint, even in part, and any reproduction of the images, even in a modified state, is only permitted with the written consent of Musikhaus Kirstein GmbH.