

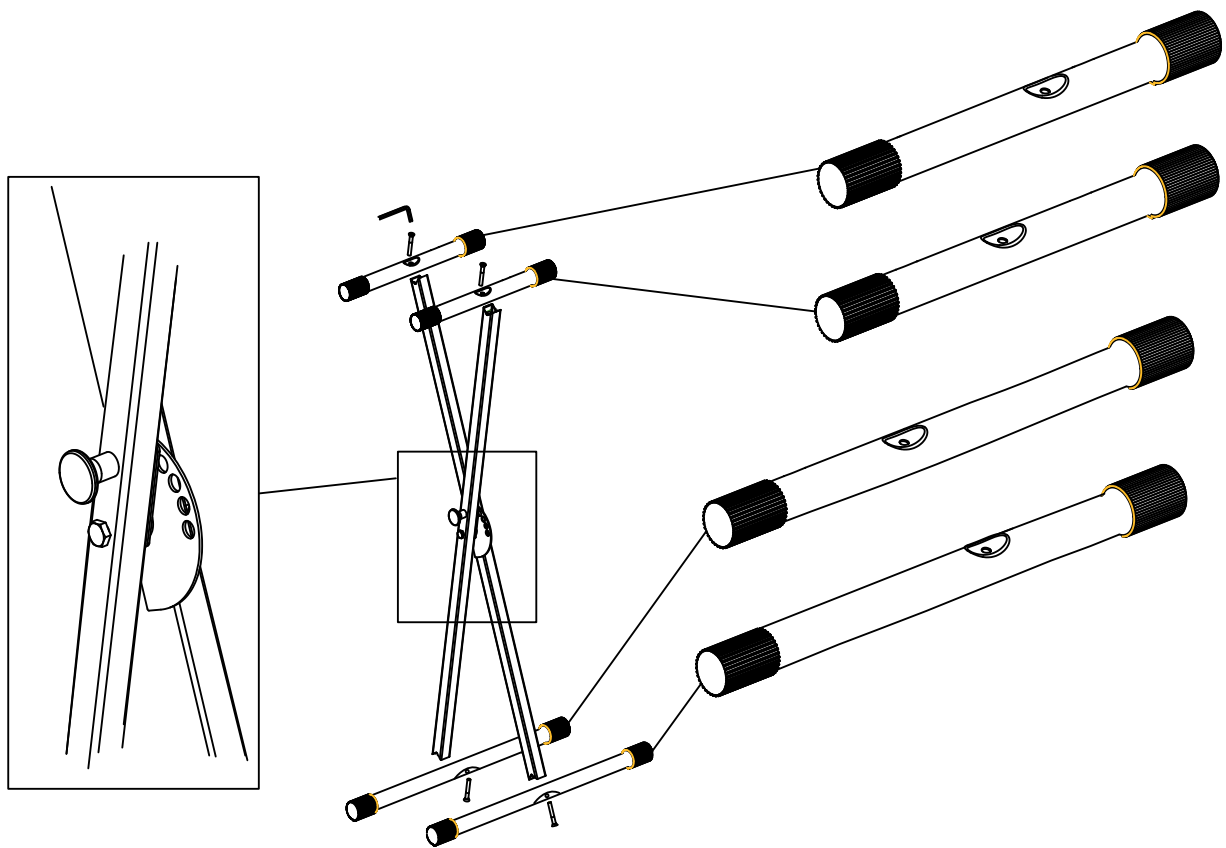

X-Keyboardständer einstrebig



 **KIRSTEIN.de**
We love music!

Musikhaus Kirstein GmbH
Bernbeurener Str. 11
86956 Schongau
www.kirstein.de

Art. 00009812 /00062730
Version 10/2019

WEEE-Declaration / Disposal

Your product is designed and manufactured with materials and components of high quality, which are recyclable and can be reused. The symbol means that your product should be disposed of separately from household waste when it reaches its end of life. Please dispose of this equipment at your local collection point or recycling center. Please help to protect the environment in which we all live.

All specifications and appearances are subject to change without notice. All information was correct at time of printing. Musikhaus Kirstein GmbH does not guarantee for the accuracy or completeness of any description, photograph or statement contained in this manual. Printed colors and specifications may vary slightly from product. Products from Musikhaus Kirstein GmbH are only sold through authorized dealer. Distributors and dealers are not agents of Musikhaus Kirstein GmbH and have no authority to bind Musikhaus Kirstein GmbH legally in any way. This manual is protected by copyright. Any copying or reprint, even in excerpts, is only allowed with written consent of Musikhaus Kirstein GmbH. The same applies to reproduction or copying of images, even in altered form.

 **KIRSTEIN.de**

Musikhaus Kirstein GmbH
Bembeurener Str. 11
86956 Schongau – Germany
Telefon/Phone: 0049-8861-909494-0
Telefax/Fax: 0049-8861-909494-19



 **MCGREY**

BS-88 Stagepiano



User Manual

Art.Nr.: 00061847 - McGrey BS-88 Beginner-Keyboard in Stagepiano Outfit
00064909 - McGrey BS-88LT Beginner-Keyboard in Stagepiano Outfit
00061856 - McGrey SK-88 Super-Kit, 88 Keys Keyboard Set
00064911 - McGrey SK-88LT Super-Kit, 88 Keys Keyboard Set

Version: 08/2020

Precautions

Please read it through carefully before proceeding.

⚠ NOTICE

- Dedicated power adapter shall be used, and in case of adaptor damage, replace it immediately
- The keyboard can only be disassembled by professionals, and no change can be made to the internal structure. In case of any functional abnormality during performance, stop performing immediately and send the keyboard to professionals for maintenance.
- When connecting the keyboard to other device, ensure both the keyboard and the device to be connected are powered off before connection.
- Do not turn and keep the volume to the maximum or to an uncomfortable degree for a long time when performing
- Keep the keyboard away from heat source to protect its parts from damage.
- Prevent liquid, dust, small particle and other foreign matters from entering the case of the keyboard, for which may result in element short circuit.
- Pull out the plug before cleaning the keyboard, and do not pull out the plug with wet hand.
- Please use dry and soft cloth to clean the keyboard. Paint, alcohol or other chemical solvents shall not be used for cleaning, for which may damage the keyboard surface.
- Please pull out the plug after performing or when the keyboard is left unused for a long time.

I. Panel Control And Extension Ports

● Front Panel Controls

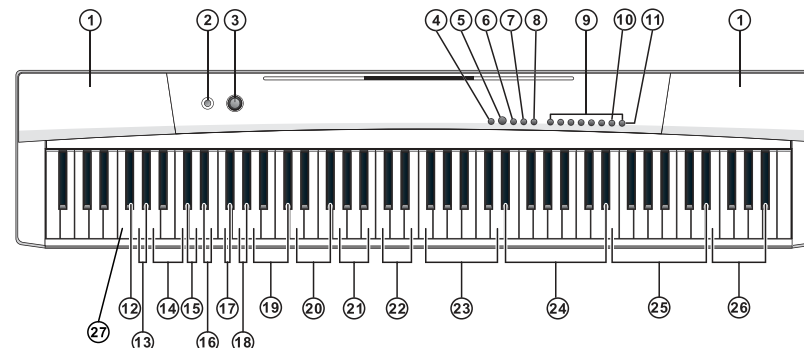

- | | | |
|-----------------|------------------|-----------------------------------|
| ① Speaker | ⑪ GM Timbre | ④+⑳ Upper Volume |
| ② Power Switch | ④+⑫ Click | ④+㉒ Metronome Volume |
| ③ Master Volume | ④+⑬ Record | ④+㉓ Metronome |
| ④ Function | ④+⑭ Touch | ④+㉔ Tempo |
| ⑤ Demo | ④+⑮ Sustain | ④+㉕ Demo Song |
| ⑥ Metronome | ④+⑯ Vibrato | ⑪+㉖ GM Timbre |
| ⑦ Lesson | ④+⑰ Transpose | ④+㉗ Udisk Music Player |
| ⑧ Split | ④+⑱ Octave | [④+⑳ Key Lighting (only XX-88LT)] |
| ⑨ Timbre | ④+⑲ Split Volume | |
| ⑩ Percussion | ④+㉑ Lower Volume | |

● Rear-Panel Controls

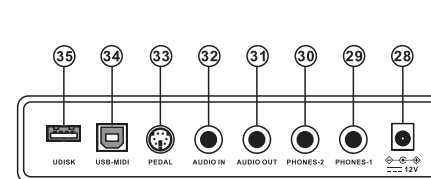

- ⑳ D. C 12V
- ㉑ PHONES-1
- ⑳ PHONES-2
- ㉒ AUDIO OUT
- ㉓ AUDIO IN
- ㉔ PEDAL
- ㉕ USB-MIDI
- ㉖ UDISK

II. Preparation

● AC/DC power adapter

Dedicated AC/DC power adapter for the Piano should be used. Connect the output end of the power adapter to the power interface on the rear panel of the Piano, and the other end to the power socket. (Please note that the input voltage of the adapter should be in line with the utility power voltage)

● Use of headphones

Two professional 6.5 mm dual-track headphones ports are provided on the Piano. When connecting a headphone to the PHONES-1 or PHONES-2 port on the rear panel of the Piano, the loudspeaker will be disabled automatically. In this way, you can carry out personal practice or four hands playing without disturbing others.

※ Caution! When using headphone, do not keep high volume for a long time, or else hearing damage may be caused.

● Connection with amplifier or audio device

The Piano is configured with an in-built loudspeaker. You may connect the Piano to other external audio devices. Firstly, turn off the Piano and the external audio device, secondly, connect one end of the audio cable to the AUDIO OUT (audio output) port on the rear panel of the Piano, and finally connect the other end to the audio input port of the audio device.

● Audio input port

The Piano is equipped with a stereo input function. Sound signals from mobile phone, MP3 player, computer and other audio devices can be input into the Piano for playing. Firstly, turn off the Piano, secondly, connect one end of the audio cable to the output port of an audio device, and the other end to the AUDIO IN port on the rear panel of the Piano, finally, turn on the Piano.

● Pedal port

The Piano is configured with a 3-in-1 pedal port which can be used for the connection of a single pedal (sustain pedal) or three pedals (soft pedal, sustain pedal and damper pedal) to simulate various sound effects during the piano performance. Connect the pedal connector to the PEDAL port on the rear panel of the Piano, and carry out required operations with the pedal.

Note: the panel is an operational item. Different configurations are provided with different pedals.

● USB-MIDI (APP) port

The USB-MIDI (APP) port of the Piano is used for the connection with a mobile phone or a tablet PC. Download and install APP teaching software to realize the connection of the Piano with smart devices, facilitating teaching and learning. Connecting method: A dedicated OTG data cable of the Piano should be used for the connection between the Piano and a mobile phone or a tablet PC. Please scan the QR code on the back cover for detailed procedures.

The USB-MIDI (APP) port of the Piano can also be used for the connection with other musical Instruments and computer with MIDI. You can output performance records to a computer for advanced recording, composing and editing with computer software, or input the MIDI music stored in the computer to the Piano for playing.

● Play U disk music

The Piano is configured with an in-built U disk music player with 32G memory, which can be used to play music of MP3 format.

Insert a U disk into the UDISK port on the rear panel, press the [FUNCTION+] + UDISK MUSIC PLAYER [ON/OFF] buttons to play MP3 music.

Press the [FUNCTION+] + UDISK MUSIC PLAYER [▶||] buttons to play or pause a track.

Press the [FUNCTION+] + UDISK MUSIC PLAYER [- ...||||| +] buttons to adjust the volume

Press the [FUNCTION+] + [◀◀] or [▶▶] buttons to go to the previous or next track.

Press the [FUNCTION+] + [↻/⌘/↻] buttons to cycle through the repeat modes for continuous, random, or single playback.

Press the [FUNCTION+] + UDISK MUSIC PLAYER [ON/OFF] buttons again to deactivate the MP3 music playing function.

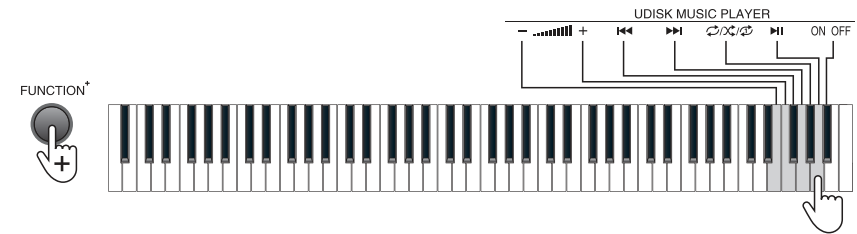

III. Basic Performance Method

Press the [POWER] button, the [PIANO] button light will light on, and then you may operate the Piano as required.

● Master volume adjustment

Turn the [MASTER VOLUME] knob clockwise to increase master volume, and anti-clockwise to decrease master volume. The master volume controls all volumes simultaneously.

● Key tone

The click function is defaulted to be enabled, press the [FUNCTION+] button + function compound key on the keyboard, a prompt tone "click" will be heard. Press the [FUNCTION+] button + the [Click] key to enable or disable the key tone function.

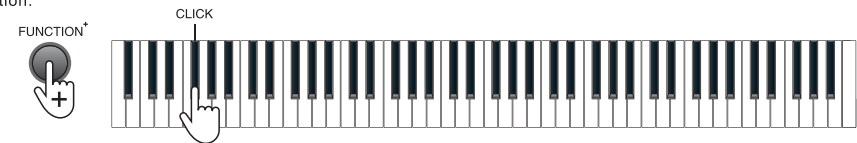

● Timbre selection

The Piano provides 140 timbres, from "000" to "139", for your selection. When the Piano is turned on, the [PIANO] button light lights on.

Default timber: the Piano provides 8 default timbers for your selection, among which, the default timber of [GM TIMBRE] is "088 Pad 1 (New Age)".

Select other timbers: press the [GM TIMBRE] button + [DEMO SONG/GM TIMBER] keys to select standard GM timber and Chinese folk timber from "000" to "139".

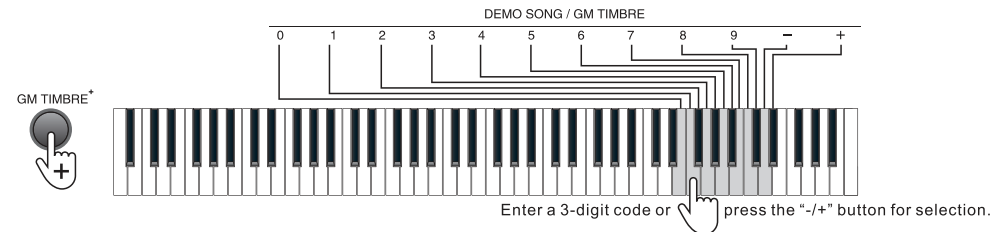

● Play demo songs

Press the [DEMO] button to play the demo songs, and press the [DEMO] button again to stop playing. The Piano provides 16 demo songs, from "00" to "15", for your selection. Press the [FUNCTION+] button + [DEMO

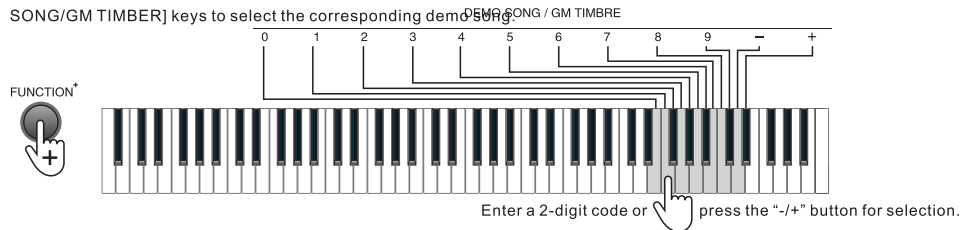

During the demo song playing process, you can select other timbres for playing the demo song. (Note: percussion and dual timber is not applicable)

IV. Metronome

● Metronome

Press the [METRONOME] button to activate the metronome. Press the [METRONOME] button again to deactivate the metronome.

The Piano contains 10 tempos. Press the [FUNCTION+] button + the [METRONOME] 1/4~12/8 keys for metronome setting.

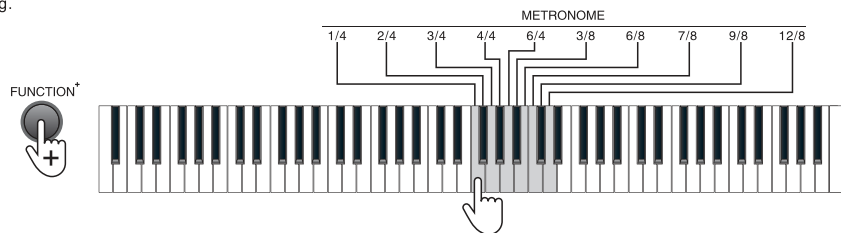

● Tempo

The tempo is defaulted to be 120, which is adjustable between the range of "30" to "300". Press the [FUNCTION+] button + [Tempo] number + "-/+ " keys to select the required tempo.

Press the [FUNCTION+] button + the [TAP] key of the [TEMPO] to restore the default value.

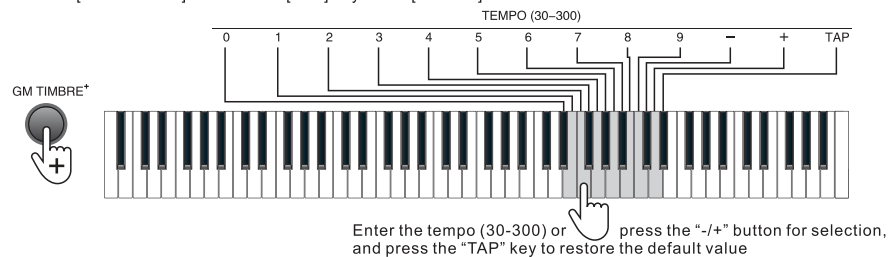

● Metronome volume

The Piano contains 5 metronome volumes. Press the [FUNCTION+] button + the [METRONOME VOLUME] 1 - 5 keys for

metronome volume setting.

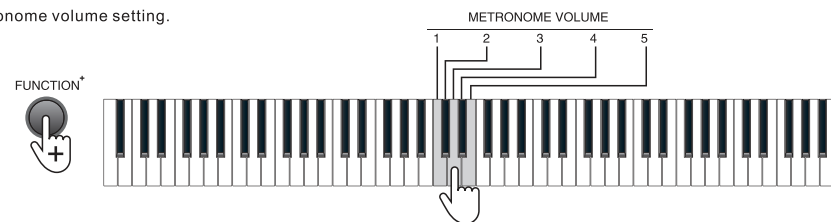

V. Effect Change

● Timbre change

◆ Sustain: prolong the lasting time of a pitch.

Press the [FUNCTION+] button + the [SUSTAIN - ON] key to enable the sustain effect.

Press the [FUNCTION+] button + the [SUSTAIN - OFF] key to disable the sustain effect.

◆ Vibrato: add a pulsating change to the pitch

Press the [FUNCTION+] button + the [VIBRATO - ON] key to enable the vibrato effect.

Press the [FUNCTION+] button + the [VIBRATO - OFF] key to disable the vibrato effect.

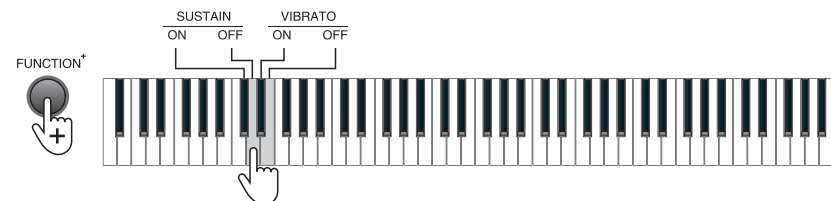

◆ Soft pedal: decrease the pitch volume

Press and hold the [soft pedal] to enable the soft effect, and release the pedal to disable such effect.

(Note: this function is only supported by the configuration with the optional items - three pedals)

◆ Sustain pedal: prolong the lasting time of a pitch.

Press and hold the [sustain pedal] to enable the sustain effect, and release the pedal to disable such effect.

(Note: this function is supported by both configurations with a single pedal or three pedals.)

◆ Damper pedal: prolong the lasting time of the pressed key.

Press and hold the [damper pedal] to enable the damper effect, and release the pedal to disable such effect.

(Note: this function is only supported by the configuration with the optional items - three pedals)

● TRANSPOSE

The transpose control function of the Piano is adjustable from "-6" to "+6", and the default setting is 0. Press the [FUNCTION+] button + the [TRANSPOSE +/-] keys for transposing within ± 6 .

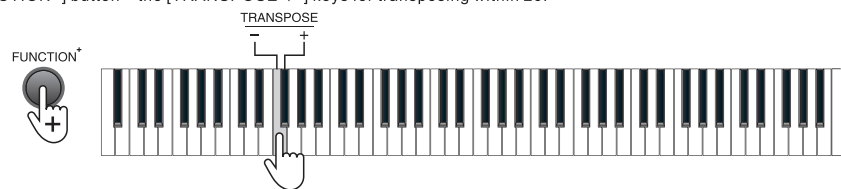

The transpose function saves the trouble of raising and lowering the key when playing on the keyboard. You can play songs in every key in the same way as that for playing songs in key C. It may decrease the key by half-step (minor second), thus the keys positions for key C is changed to those for key B; press the "+" button to increase all keys by half-step (minor second), in this case, the tone of the key position of key C is changed to key C# or key Db. If the button is pressed for twice, key C will decrease to Bb; and if the button is pressed for fifth times, key C will decrease to key F. Press the "+" and "-" buttons simultaneously to reset key C.

● Touch control

Press the [FUNCTION+] button + [TOUCH] OFF, 1-3 keys to turn off or shift touch force among 3 grades.

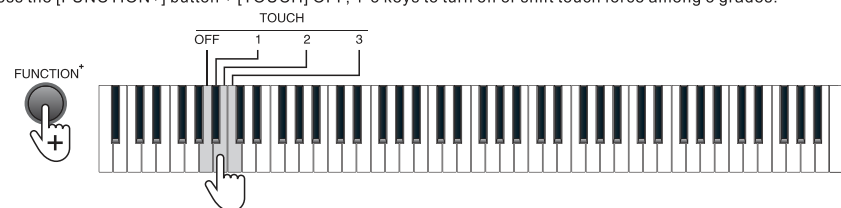

● Split

The keyboard can be split into two zones, in this way, you can play two different timbres with your left and right hands respectively. You should set the timbre for the right hand side after the timbre that you were using before splitting is applied to the left-hand side. For example, you can set the timbre of the left-hand side to bass and the right-hand side to piano.

◆ Press the [SPLIT+] button to split the keyboard, and press the [SPLIT+] button again to disable the keyboard split. Press the [SPLIT+] button for the first time and press the key simultaneously to set the split point. The currently pressed key will be the first key of the right-hand side.

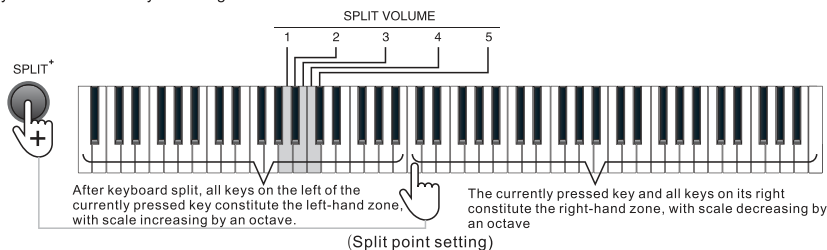

◆ When the keyboard split function is enabled, the scale of the left-hand zone will increase by an octave, and the scale of the right-hand zone will decrease by an octave. Take the default split point as an example, scales of Keys A0 - G2# will change to those of Keys A1 - G3#, while scales of Keys A2 - C8 will change to those of Keys A1 - C7.

◆ Press the [FUNCTION+] button and [SPLIT] 1 - 5 keys to set the volume for the left-hand zone.

◆ After the keyboard split function is enabled, you can reselect a timbre for the right-hand zone.

● Dual timbre

Press any two timbre buttons simultaneously to enable the dual timbre function, in this case, the two selected timbre will be overlaid.

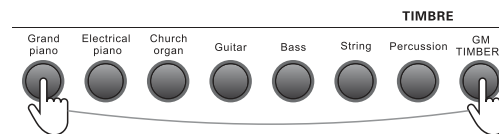

When overlay of other timbres are required, press the [GM TIMBRE] button + the [DEMO SONG/GM TIMBRE] key to select other timbres, and then press the [GM TIMBRE] and other [TIMBRE] buttons simultaneously.

Both volumes for the upper layer and the lower layer have 5 grades: the volume of the first selected timbre is adjusted via the upper volume by pressing the [FUNCTION+] button + the [UPPER VOLUME 1 - 5] keys on the keyboard; the volume of the later selected timbre is adjusted via the upper volume by pressing the [FUNCTION+] button + the [LOWER VOLUME 1 - 5] keys;

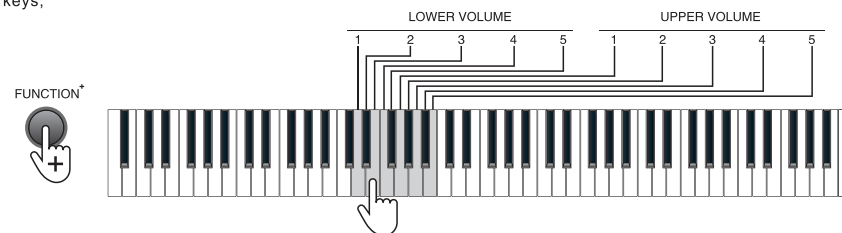

VI. Lesson Mode

● Lesson Mode

In the lesson mode, the 88 keys are split into two zones with identical tone and timbre, which facilitates the demonstration by teacher-level students, and two persons can play the piano simultaneously.

Press the [LESSON] button for the first time to activate the lesson mode, press the [LESSON] button again to disable this function.

Under the lesson mode, the scales of Keys A0 - C5 in the left zone will change to the scales of Keys A2 - C6, while the scales of Keys C4# - C8 in the right zone will change to the scales of Keys C2# - C6.

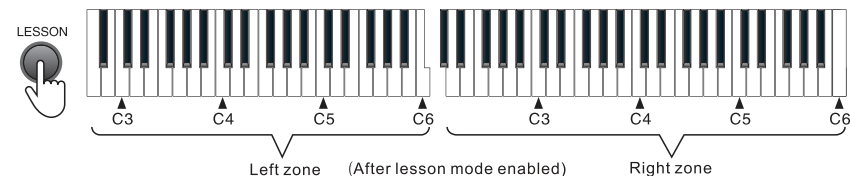
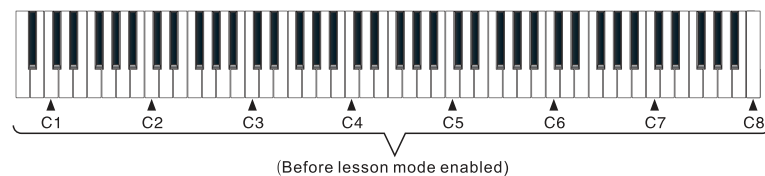

● **Octave control**

Under the lesson mode, you can perform octave adjustment from "-2" to "+2", and the default setting is 0. Press the [FUNCTION+] button + the [OCTAVE] "-" / "+" keys for octave adjustment within ± 2 . For example, when adjusting octave to "-2", the left zone will change to A0-C4 while the right zone will change to C0#-C4.

Press the [FUNCTION+] button + [OCTAVE] "-" / "+" keys simultaneously to restore the default setting.

Note: octave control can only be enabled under the lesson mode.

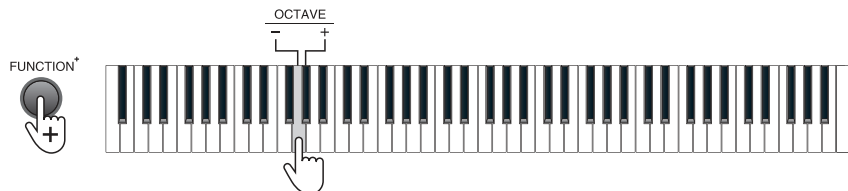

VII. Record Mode

● **Record**

Press the [FUNCTION+] button + the [REC] key to enable the record mode. Press the [FUNCTION+] button + the [REC] key again to disable the record mode.

Under the record mode, the metronome will be enabled automatically, and you can press any key to start recording. Press the [FUNCTION+] button + the [TEMPO] key to adjust the tempo.

The Piano can record 700 notes at maximum. When the storage memory is full, the record mode will be disabled and the metronome will shut down automatically.

● **Play**

Press the [FUNCTION+] button + the [PLAY] key to play the records. During the playing process, press the [FUNCTION+] button + the [PLAY] key again to stop playing.

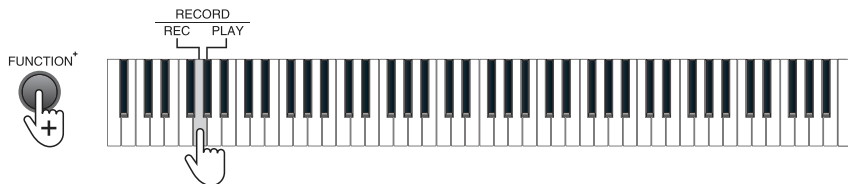

Appendix Timbre Table

000 Acoustic Grand Piano	035 Fretless Bass	070 Bassoon	105 Banjo
001 Bright Acoustic Piano	036 Slap Bass 1	071 Clarinet	106 Shamisen
002 Electric Grand Piano	037 Slap Bass 2	072 Piccolo	107 Koto
003 Honky-tonk Piano	038 Synth Bass 1	073 Flute	108 Kalimba
004 Rhodes Piano	039 Synth Bass 2	074 Recorder	109 Bagpipe
005 Chorused Piano	040 Violin	075 Pan Flute	110 Fiddle
006 Harpsichord	041 Viola	076 Bottle Blow	111 Shanai
007 Clavichord	042 Cello	077 Shakuhachi	112 Tinkle Bell
008 Celesta	043 Contrabass	078 Whistle	113 Agogo
009 Glockenspiel	044 Tremolo Strings	079 Ocarina	114 Steel Drums
010 Music Box	045 Pizzicato Strings	080 Lead 1 (square)	115 Woodblock
011 Vibraphone	046 Orchestral Harp	081 Lead 2 (sawtooth)	116 Taiko Drum
012 Marimba	047 Timpani	082 Lead 3 (calliope lead)	117 Melodic Tom
013 Xylophone	048 String Ensemble 1	083 Lead 4 (chiff lead)	118 Synth Drum
014 Tubular Bell	049 String Ensemble 2	084 Lead 5 (charang)	119 Reverse Cymbal
015 Dulcimer	050 Synth Strings 1	085 Lead 6 (voice)	120 Guitar Fret Noise
016 Drawbar Organ	051 Synth Strings 2	086 Lead 7 (fifths)	121 Breath Noise
017 Percussive Organ	052 Choir Aahs	087 Lead 8 (bass+lead)	122 Seashore
018 Rock Organ	053 Voice Oohs	088 Pad 1 (new age)	123 Bird Tweet
019 Church Organ	054 Synth Voice	089 Pad 2 (warm)	124 Telephone Ring
020 Reed Organ	055 Orchestra Hit	090 Pad 3 (polysynth)	125 Helicopter
021 Accordion	056 Trumpet	091 Pad 4 (choir)	126 Applause
022 Harmonica	057 Trombone	092 Pad 5 (bowed)	127 Gunshot
023 Tango Accordion	058 Tuba	093 Pad 6 (metallic)	128 Yong Gin
024 Acoustic Guitar (nylon)	059 Muted Trumpet	094 Pad 7 (halo)	129 Zheng
025 Acoustic Guitar (steel)	060 French Horn	095 Pad 8 (sweep)	130 Zhong Ruan
026 Electric Guitar (jazz)	061 Brass Section	096 FX 1 (rain)	131 Pi Pa
027 Electric Guitar (clean)	062 Synth Brass 1	097 FX 2 (soundtrack)	132 Big Souna
028 Electric Guitar (muted)	063 Synth Brass 2	098 FX 3 (crystal)	133 Souna
029 Overdriven Guitar	064 Soprano Sax	099 FX 4 (atmosphere)	134 Er Hu
030 Distortion Guitar	065 Alto Sax	100 FX 5 (brightness)	135 Yue Hu
031 Guitar Harmonics	066 Tenor Sax	101 FX 6 (goblins)	136 Di Zi
032 Acoustic Bass	067 Baritone Sax	102 FX 7 (echoes)	137 Bong Di
033 Electric Bass (finger)	068 Oboe	103 FX 8 (sci-fi)	138 Koto
034 Electric Bass (pick)	069 English Horn	104 Sitar	139 Qu Di