

WEEE-Declaration

Your product is designed and manufactured with materials and components of high quality, which are recyclable and can be reused.  
The symbol means that your product should be disposed of separately from household waste when it reaches its end of life.  
Please dispose of this equipment at your local collection point or recycling center.  
Please help to protect the environment in which we all live.

Intellectual property /Copyright

All specifications and appearances are subject to change without notice.  
All information was correct at time of printing. Musikhaus Kirstein GmbH does not guarantee for the accuracy or completeness of any description, photograph or statement contained in this manual.  
Printed colours and specifications may vary slightly from product. Products from Musikhaus Kirstein GmbH products are only sold through authorized dealers. Distributors and dealers are not agents of Musikhaus Kirstein GmbH and have no authority to bind Musikhaus Kirstein GmbH legally in any way.  
This manual is protected by copyright. Any copying or reprint, even in excerpts, is only allowed with written consent of Musikhaus Kirstein GmbH.  
The same applies to reproduction or copying of images, even in altered form.

# 61 Edition Touch

## User's Manual



## CAUTION

Please observe the following basic information in order not to endanger yourself or others and to avoid damage to external devices.

### Caution

Do not disassemble the instrument and do not modify it. This could result in electric shock. Entrust a specialist workshop with any necessary service and maintenance or contact your dealer.

- If you notice that the power cord shows signs of wear and tear, the unit has a misfire, smells or smells burned, remove the plug from the socket immediately and have a technician repair it.
- Before cleaning the instrument, disconnect it from the power supply.
- Always place the instrument on even, stable surfaces to prevent it from wobbling or falling over.
- Fix the piano on its stand with the enclosed screws so that it can not fall down.
- Do not use the instrument in a damp or wet environment.
- Do not place vessels filled with liquids, such as vases, glasses or bottles on it.
- Do not place small objects on it that could slip in, such as hairpins, sewing needles or coins.
- Do not place burning candles on the instrument.:

### Notice

- To prevent damage to the piano, do not place it in places with high temperatures or high dust, do not place it next to an air conditioner and avoid direct sunlight.
- Do not place the instrument near other electrical equipment to avoid interference.
- Do not use force handling the instrument or place heavy objects on the unit.
- Disconnect the instrument from the power if you are not going to use it for a long time.

To disconnect the device from the mains, pull the plug, not the cable.

- Please handle the power cable carefully. It should not be near radiators, you should not place heavy objects on it and move it so that people can not step on it or fall over it.
- Please note that continuous high volume can permanently damage your hearing. Adjust the volume carefully.

## Appendix V. Technical specifications

### ■ Keyboard

· 61 keys standard piano keys with touch response

### ■ Display

· LED display

### ■ Tone

· 300 kinds of tones

### ■ Rhythm

· 300 kinds of auto accompaniment

### ■ Demo

· 40 demo

### ■ Effect control

· Dual voice, sustain, vibrato, keyboard split, transpose, intro/ending, metronome, touch

### ■ Record and program

· Record  play  program

### ■ Other function

· 8 kinds of panel percussion

### ■ Accompaniment control

· Start/stop  sync  tempo control

### ■ Chord control

· Single chord  finger chord  chord clear  chord volume

### ■ Intelligent teaching

· Demo one  one key teaching  follow teaching

### ■ Other control

· Power switch  accompaniment volume control

### ■ External jack

· DC9V power input  USB MIDI  headphone  microphone

### ■ Diapason

· C2-C7

### ■ Intonation

· ≤5 cents

### ■ Keyboard size

· 1008x431x171 (mm)

### ■ Net weight

· 5.14Kg

### ■ Power adapter

· DC9V 500mA

### ■ Quiescent current

· 120mA

### ■ Accessories that were equipped with this keyboard

· Adapter, Music stand, User manual

## Appendix IV.Trouble and exclusion

Trouble	Possible causes/resolution
Accompanying a slight noise in turning on/off power	Do not worry,it's the normal phenomenon.
There was no sound when you pressed keyboard on power state.	Check whether the master volume button was set at proper position or headphone out jack was connected with other equipment so the built-in speaker system cutted off automatically
Distorted or discontinued sound , or even system halted	Using unqualified AC adaptor or low batteries.Please use the AC adaptor provided with this electronic keyboard or replace batteries.
The note and its tone quality of a same tone are a little different.	This is normal phenomenon caused by different tone sampling diapason.
When use the sustain function, some tone has long sustain but some has short sustain.	This is normal phenomenon because the best length of the sustain of the different tone has been set.
The main volume and accompaniment volume are abnormal.	Check the main volume control and the accompaniment volume control are set at the proper position.
In sync status,but the auto accompaniment does not work.	Now pressing a note at left-hand keyboard area (19 keys in the left of keyboard).
When use the external adapter, The electronic keyboard has no sound when power is on, the LCD has no displaying	Check whether power socket has the electricity,the power adapter has been inserted well,or the power jack has the poor connection , the voltage is not enough. Or the adaptor has been damaged.
When use the batteries,the keyboard has no sound when power is on,LCD has no displaying.	Check whether batteries polarity was correct and the batteries have run down.
The pitch of nore is not correct.	Check whether the parameter of transpose is "00".
When use the mobilephone, the keyboard has the noise.	Mobilephone can disturb the keyboard,to avoid the noise,pls turn off the mobilephone or use it in far place.

## Contents

<b>I. panel control and external function</b> .....	1
1.panel control .....	1
2.external function .....	1
<b>II.Preparation before performance</b> .....	1
<b>Power requirement</b> .....	1
1.use power adapter .....	1
2.use battery .....	2
<b>Accessories jacks</b> .....	2
1.USB MIDI jack .....	2
2. Use microphone .....	2
3. Use headphone .....	2
<b>III. Basic operation method</b> .....	2
<b>Basic operation</b> .....	2
1. Turn on the power .....	2
2. Master volume adjustment .....	3
<b>Tone</b> .....	3
1. Tone selection .....	3
<b>Effects and control</b> .....	3
1.Dual voice .....	3
2.Sustain function .....	3
3.Vibrato function .....	3
4.Keyboard split .....	4
5.Tempo adjustment .....	4
6.Transpose adjustment .....	4
7.Touch .....	4
8.Metronome .....	4
9.Panel percussion .....	5
<b>Rhythm and relative rhythm function</b> .....	5
1.Rhythm selection .....	5
2.Start/Stop .....	5
3.Sync .....	5
4.Intro/Ending .....	5
5.Accompaniment volume adjustment .....	5
<b>Chord accompaniment</b> .....	6
1.Single chord .....	6
2.Finger chord .....	6
3.Chord clear .....	6
4.Chord volume .....	6
<b>Record function</b> .....	6
<b>Demo one</b> .....	7
<b>Teaching function</b> .....	7
<b>Appendix I.Tone list</b> .....	8
<b>Appendix II.Rhythm list</b> .....	9
<b>Appendix III.Demo songs list</b> .....	10
<b>Appendix IV.Trouble and exclusion</b> .....	11
<b>Appendix V.Technical specifications</b> .....	12

# 1 I.Panel control and external function

## Panel control

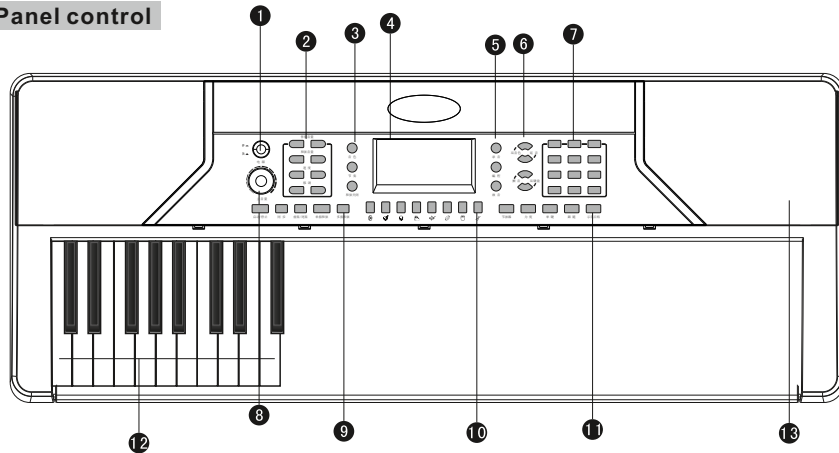

- 1. Power switch
- 2. Accom volume±/Chord volume/Tempo±/Transpose±
- 3. Tone/Rhythm/Chord clear
- 4. LCD display
- 5. Record/Program/Play
- 6. Dual voice/Sustain/Vibrato /Keyboard split
- 7. Number 0-9/+,-
- 8. Master volume
- 9. Start/stop/sync/Intro/ending /Single chord/Finger chord
- 10. Panel percussion
- 11. Metronome/ Touch/ One key teaching/ Follow teaching/ Demo one
- 12. Chord area
- 13. Loudspeaker

## External jacks

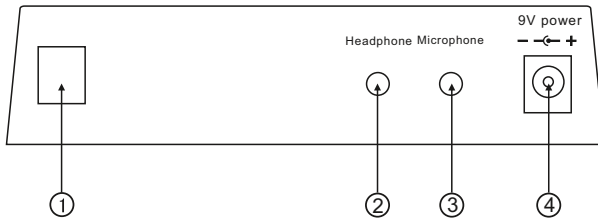

- 1. USB MIDI jack
- 2. headphone output
- 3. microphone jack
- 4. DC 9V power input jack

# II.Preparation before performance

## Power requirement

### 1.Using AC/DC power adaptor

Please use the special power adaptor was equipped with this electronic keyboard or the power adaptor with DC 9V out voltage, 500mA out current and central anode plug. Insert the DC plug of power adaptor into the DC 9V power jack in the rear panel of electronic keyboard, then, insert the other end into Mains socket. (Notice: The input voltage of power adaptor must conform to the voltage of Mains) ,finally turn on power switch and start performance.

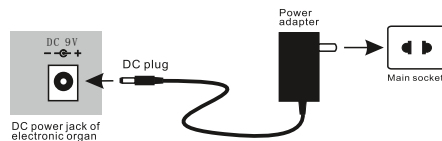

# Appendix III.Demo list

No.	Song name	No.	Song name	No.	Song name
00	Turkey March	14	Chong Erfei	28	In rain
01	Red River Valley	15	Minuet in G major	29	long time ago
02	American Patrol	16	Spanish Matador	30	Magic Flute Overture
03	Susanna	17	Serenade - Haydn	31	Silent Night
04	Mozart Piano Sinata	18	Yankee Doodle	32	Hungary Dance
05	Mariage d'amour	19	Waltz	33	Western is gone
06	Waterside Adi Lina	20	Minuet	34	Fountain
07	Smile Polka	21	Rain Melody	35	Mary had a little lamb
08	Jingle Beus	22	Frosty	36	Music Box Dance
09	Lardesik March	23	Old French	37	Four Seasons
10	Mozart No.40	24	Blue Danube	38	Concerto Of Love
11	Clapping song	25	A small brown bottle	39	Destiny
12	Fur Elise	26	Hawthorn		
13	Katyusha	27	River Of Babylon		

NO.	Rhythm name	NO.	Rhythm name	NO.	Rhythm name	NO.	Rhythm name	NO.	Rhythm name
00	Soul 1	60	Swing 4	120	Waltz 2	180	Japanese Folk Music	240	CountryDance2
01	Soul 2	61	Swing 5	121	Waltz 3	181	Trip Hop 1	241	CountryDance3
02	Soul 3	62	Swing 6	122	Waltz 4	182	Trip Hop2	242	World Fusion
03	Soul 4	63	Baiao	123	Jazz Waltz 1	183	Chamber pop1	243	Chinese traditional1
04	Soul 5	64	Bolero	124	Jazz Waltz 2	184	Chamber pop12	244	Chinese traditional2
05	Soul 6	65	Bossanova 1	125	Jazz Waltz 3	185	PopSwing1	245	Chinese traditional3
06	Soul 7	66	Bossanova 2	126	Country Waltz 1	186	PopSwing2	246	Thailand Rhythm
07	Soul 8	67	Bossanova 3	127	Country Waltz 2	187	PopSwing3	247	ModernWaltz1
08	Slow Soul 1	68	Bossanova 4	128	JazzSoul1	188	PopSwing4	248	ModernWaltz2
09	Slow Soul 2	69	Bossanova 5	129	JazzSoul2	189	PopSwing5	249	ModernWaltz3
10	Slow Soul 3	70	Calypso	130	JazzSoul3	190	PopSwing6	250	ModernWaltz4
11	Slow Soul 4	71	Habanera	131	JazzSoul4	191	Celtic Pop	251	Britpopwaltz1
12	Slow Soul 5	72	Reggae 1	132	JazzSoul5	192	Hawaiian Pop	252	Britpopwaltz2
13	Funkey soul 1	73	Reggae 2	133	JazzSoul6	193	SoftBossanova1	253	Britpopwaltz3
14	Funkey soul 2	74	Jorpo	134	JazzSoul7	194	SoftBossanova2	254	Contemporary Waltz1
15	Funkey soul 3	75	Tango 1	135	JazzSoul8	195	SoftBossanova3	255	Contemporary Waltz2
16	Funkey soul 4	76	Tango 2	136	Light Beat 1	196	SoftBossanova4	256	ModernSoul1
17	Funkey soul 5	77	Tango 3	137	Light Beat 2	197	SoftBossanova5	257	ModernSoul2
18	Funkey soul 6	78	Manbo 1	138	Light Beat 3	198	Mento	258	ModernSoul3
19	Funkey soul 7	79	Manbo 2	139	Light Beat 4	199	Shima Uta	259	ModernSoul4
20	Funkey soul 8	80	Rhumba 1	140	Light Beat 5	200	Reggae-Pop1	260	ModernSoul5
21	West Coast	81	Rhumba 2	141	SoulPsychedelic 1	201	Reggae-Pop2	261	ModernSoul6
22	Euro Soul	82	Rhumba 3	142	SoulPsychedelic 2	202	European Traditions	262	ModernSoul7
23	16 AOR 1	83	Rhumba 4	143	SoulPsychedelic 3	203	TangoPop1	263	ModernSoul8
24	16 AOR 2	84	Rhumba 5	144	SoulPsychedelic 4	204	TangoPop2	264	Classical Soul 1
25	16 Beat 1	85	Bequine	145	SoulPsychedelic 5	205	TangoPop3	265	Classical Soul 2
26	16 Beat 2	86	Salsa	146	SoulPsychedelic 6	206	Rhythm Mambo 1	266	Classical Soul 3
27	16 Beat 3	87	Merengue 1	147	SoulPsychedelic 7	207	Rhythm Mambo 2	267	Classical Soul 4
28	16 Ballad 1	88	Merengue 2	148	SoulPsychedelic 8	208	BritRhumba 1	268	Classical Soul 5
29	16 Ballad 2	89	Vallentao	149	Goth Psychedelic	209	BritRhumba 2	269	Contemporary R&b1
30	Pop Dance 1	90	Plena	150	Psychedelic swing	210	BritRhumba 3	270	Contemporary R&b2
31	Pop Dance 2	91	Lambada	151	Folkrock1	211	BritRhumba 4	271	Contemporary R&b3
32	Pop Dance 3	92	Bachata 1	152	Folkrock2	212	BritRhumba 5	272	Contemporary R&b4
33	Shuffle 1	93	Bachata 2	153	New century1	213	SoulBequine	273	Contemporary R&b5
34	Shuffle 2	94	Bachata 3	154	New century2	214	Chamber pop	274	Contemporary R&b6
35	8 Shuffle	95	Samba 1	155	New century3	215	Neo-Merengue1	275	Contemporary R&b7
36	Hard Rock	96	Samba 2	156	16 Pop 1	216	Neo-Merengue2	276	Contemporary R&b8
37	Slow Rock 1	97	Pop Samba 1	157	16 Pop 2	217	Big Beat	277	Deep Funk
38	Slow Rock 2	98	Pop Samba 2	158	Modern dance1	218	PlenaBeat	278	European Jazz
39	Pop Classic	99	Pop Samba 3	159	Modern dance2	219	Downtempo	279	70' Rock
40	Blues	100	Jazz Samba	160	Modern dance3	220	ElectricBachata 1	280	80' Rock
41	Twist	101	March 1	161	Modern dance4	221	ElectricBachata 2	281	16 SoftRock 1
42	Hard 3 Beat	102	March 2	162	Modern dance5	222	ElectricBachata 3	282	16 SoftRock 2
43	Love Ballad 1	103	March 3	163	8 Post Rock	223	FolkSamba1	283	16 SoftRock 3
44	Love Ballad 2	104	March 4	164	ClassicRock	224	FolkSamba2	284	16 BalladRock 1
45	Love Ballad 3	105	Polkal 1	165	JazzRock1	225	Jump Samba 1	285	16 BalladRock 2
46	Love Ballad 4	106	Polkal 2	166	JazzRock2	226	Jump Samba 2	286	Afro Dance 1
47	Euro Beat	107	Polkal 3	167	Traditional Pop	227	Jump Samba 3	287	Afro Dance 2
48	House 1	108	C&W 1	168	Country Blues	228	Afro Samba	288	Afro Dance 3
49	House 2	109	C&W 2	169	Indian Pop	229	Rock March1	289	JazzShuffle1
50	Swing Beat	110	Bluegrass	170	Hard 3 Rock	230	Rock March2	290	JazzShuffle2
51	8 Ballad	111	Country 1	171	Classical ballad1	231	Rock March3	291	8 JazzShuffle
52	Step	112	Country 2	172	Classical ballad2	232	Rock March4	292	Heavy metal rock
53	Big Band 1	113	Country 3	173	Classical ballad3	233	PolkaBlues1	293	RockDance1
54	Big Band 2	114	Middle East	174	Classical ballad4	234	PolkaBlues2	294	RockDance2
55	Conbmo 1	115	China 1	175	Light Ballad	235	PolkaBlues3	295	Middle East Pop
56	Conbmo 2	116	China 2	176	Deep House	236	CountryRock1	296	Soul Blues
57	Swing 1	117	China 3	177	Hard House	237	CountryRock2	297	Glam Rock
58	Swing 2	118	Thailand	178	House dance	238	Jazz Blues	298	Hard House
59	Swing 3	119	Waltz 1	179	8 Pop	239	CountryDance1	299	Light Ballad

Caution:When you don't use this electronic keyboard, you should unplug the plug of power adaptor from power socket safely to avoid the parts trouble or other accident for long-term charging

## 2.Using batteries for power supply

Open the battery lid at the bottom of electronic keyboard and load 8pcs 1.5V size D batteries , ensure the polarity of the batteries should conform to the anode and cathode direction of batteries marked on battery lid. Cover the battery lid after the installation.

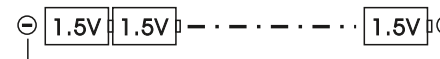

8 batteries altogether

Caution : Don't use different kinds of batteries at the same time and mix new and old batteries for use.The volume will go down and the timbre will be bad if the electrical quantity of batteries isn't enough,you have to replace the new batteries now.Please take out the batteries as to avoid possible damage caused by the batteries leakage if you don't use the electronic keyboard for long time.

## Accessories jacks

### 1. USB MIDI jack

Connect USB jack of this keyboard to USB jack of another electronic equipment that is compatible with MIDI by USB line,this electronic keyboard can receive and send MIDI equipment data.

Caution:The USB audio equipment can't be setted for input and output at the same time when you do the setting of the computer software,or else the sound will be overlapping when you play the keys.It can support the system that is above WIN7.

### 2.Use external microphone

Insert electret microphone(plug size:3.5MM) into microphone jack

### 3.Use headphone

Insert headphone plug into[HEADPHONE] jack in back of electronic keyboard.The internal speaker system of electronic keyboard cuts off automatically now.Using headphone doesn't interfere with others during performance,it is special for personal monitor and exercising at night.



Notice:The above external device wasn't equipped with this keyboard,users have to buy themselves,please understand this point,tk.

## III.Basic operation method

### Basic operation

#### 1.Turn on power

Press[Power]button to turn on power after power adaptor was well connected or batteries were installed correctly.Press[Power]button again,the button bounces,the power was closed.



### III.Basic operation method

#### 2.Master volume adjustment

To adjust higher or lower volume by rotating volume knob,the volume will be higher by rotating clockwise,the volume will be lower by rotating counterclockwise. The accompaniment volume has relative change at the time the main volume was adjusted.



#### Tone

##### 1.Tone selection

This keyboard has 300 kinds of voice,the default state is voice when power was on,you need to press [Tone] button if present state isn't tone. The voice can be chosen by number 0-9 buttons or [+/-] buttons(As shown in the left diagram)

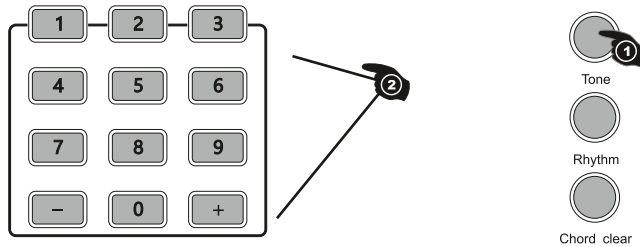

#### Effects and control

##### 1.Dual voice

Press[Dual Voice]button in normal state,the keyboard enters into dual voice mode.It is one note was composed by two kinds of tones,First tone is the tone before pressing [Dual Voice] button,second tone is choosed tone after pressed[Dual Voice]button.

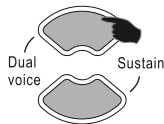

##### 2.Sustain function

Press[Sustain]button to start sustain function. The prolonged effect will occur if you play with white and black keys at this time.Pressing[Sustain] button again to exit sustain function.

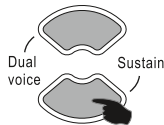

##### 3.Vibrato function

Press [Vibrato] button to start vibrato function,the trembling effect will occur if you play with white and black keys at this time.Pressing[Vibrato]button again to exit vibrato function.

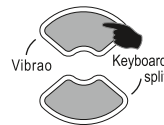

NO.	Name of tone	NO.	Name of tone	NO.	Name of tone	NO.	Name of tone	NO.	Name of tone
00	Acoustic Grand Piano	60	French Horn	120	Guitar Fret Noise	180	Bright Violin	240	Psychedelic Synth Lead
01	Bright Acoustic Piano	61	Brass Section	121	Breath Noise	181	Stringed violin	241	Vibraphone Synth Lead
02	Electric Grand Piano	62	Synth Brass 1	122	Seashore	182	Trill violin	242	Marimba Synth Lead
03	Honky-tonk Piano	63	Synth Brass 2	123	Bird Tweet	183	Electronic violin	243	Metal FX
04	Rhodes Piano	64	Soprano Sax	124	Telephone Ring	184	Large violin	244	Electronic FX
05	Chorused Piano	65	Alto Sax	125	Helicopter	185	rhythm Orchestra	245	Electronic String Ensemble
06	Harpsichord	66	Tenor Sax	126	Applause	186	Pizzicato Violin	246	Wind FX
07	Clavichord	67	Baritone Sax	127	Gunshot	187	Pizzicato Ensemble 1	247	Clarinet FX
08	Celesta	68	Oboe	128	Percussion	188	Pizzicato Ensemble 2	248	Organ FX
09	Glockenspiel	69	English Horn	129	Rhythm electric Piano	189	Percussion band	249	Crystal FX
10	Music box	70	Bassoon	130	Baritone Xylophone	190	Baritone Synth Contrabass	250	Synth Shamisen
11	Vibraphone	71	Clarinet	131	Clean Piano	191	Bass Flute	251	Electronic Shamisen
12	Marimba	72	Piccolo	132	Bright Dulcimer	192	Distortion Contrabass	252	Bright Sitar
13	Xylophone	73	Flute	133	Rhythm Grand Piano	193	Contrabass Lead	253	Whistle Accord
14	Tubular Bells	74	Recorder	134	Traditional Piano	194	Violin Lead	254	rhythm Nation
15	Dulcimer	75	Pan Flute	135	Aluminium jean	195	Cello Lead	255	Bright Koto
16	Hammond Organ	76	Bottle Blow	136	Rock Grand Piano	196	Pizzicato rhythm	256	Koto Lead
17	Percussive Organ	77	Shakuhachi	137	Electronic organ	197	high Harp	257	Diplophonia Koto
18	Church Organ	78	Whistle	138	Psychedelic electronic	198	Harp ensemble	258	Baritone Koto
19	Reed Organ	79	Ocarina	139	Water jean	199	Synth Harp	259	Synth Koto
20	Accordion	80	Lead 1 (square)	140	Bright Guitar	200	Baritone Trumpet	260	Environmental Lead
21	Harmonica	81	Lead 2 (sawtooth)	141	Orchestra piccolo	201	Trumpet ensemble	261	Metal Lead
22	Tango Accordion	82	Lead 3 (caliope lead)	142	Heavy metal guitar	202	rhythm Trumpet	262	Orchestra Lead
23	Acoustic Guitar (nylon)	83	Lead 4 (chiff lead)	143	Crystal guitar	203	high Trumpet	263	Glockenspiel Lead
24	Acoustic Guitar (steel)	84	Lead 5 (charang)	144	Queer electric Piano	204	Synth Trumpet	264	Bass Lead
25	Electric Guitar (jazz)	85	Lead 6 (voice)	145	Bright bass	205	Baritone Trombone	265	Fifths Lead
26	Electric Guitar (clean)	86	Lead 7 (fifths)	146	Rock Electric Bass	206	Trombone ensemble	266	Wind Lead
27	Electric Guitar (muted)	87	Lead 8 (bass+lead)	147	Rhythm Electric Bass	207	rhythm Trombone	267	Atmosphere Lead
28	Overdriven Guitar	88	Pad 1 (new age)	148	Psychedelic Bass	208	rhythm Trombone	268	Sharp Lead
29	Distortion Guitar	89	Pad 2 (warm)	149	Heavy metal bass	209	baritone Trombone	269	Bright Lead
30	Guitar Harmonics	90	Pad 3 (polysynth)	150	Magic electronic	210	Synth Trombone	270	East Nation Pad
31	Acoustic Bass	91	Pad 4 (choir)	151	Bright violin	211	Violin French Horn	271	Atmosphere Pad
32	Electric Bass (finger)	92	Pad 5 (bowed)	152	Atonic violin	212	French Horn ensemble	272	Electric bass Pad
33	Electric Bass (pick)	93	Pad 6 (metallic)	153	Heavy bass orchestra	213	Electronic French Horn	273	electric Piano Pad
34	Fretless Bass	94	Pad 7 (halo)	154	Synth clarinet	214	Synth French Horn	274	Clean Guitar Pad
35	Slap Bass 1	95	Pad 8 (sweep)	155	Interactive Lead	215	Psychedelic Synth Brass	275	Western Pad
36	Slap Bass 2	96	FX 1 (rain)	156	For the keyboard	216	Distortion Synth Brass	276	Sci-fi Pad
37	Synth Bass 1	97	FX 2 (soundtrack)	157	Bagpipes	217	Vibraphone Synth Brass	277	Metal Sci-fi Pad
38	Synth Bass 2	98	FX 3 (crystal)	158	Suona	218	Synth Muted Trumpet	278	Clarinet Pad
39	Violin	99	FX 4 (atmosphere)	159	Pipa	219	Rock Synth Brass	279	Electronic dance Pad
40	Viola	100	FX 5 (brightness)	160	Church Piano	220	Soprano Sax ensemble	280	Double Kalimba
41	Cello	101	FX 6 (goblins)	161	Church electric Piano	221	rhythm Soprano Sax	281	Bright Kalimba
42	Contrabass	102	FX 7 (echoes)	162	Synth Piano	222	Synth Soprano Sax	282	Crystal Kalimba
43	Tremolo Strings	103	FX 8 (sci-fi)	163	Baritone Piano	223	National Sax	283	Synth Kalimba
44	Pizzicato Strings	104	Sitar	164	Piano PAD	224	Metal Sax	284	Electronic Bagpipe
45	Orchestral Harp	105	Banjo	165	String Piano	225	Baritone Sax ensemble	285	Wind Bagpipe
46	Timpani	106	Shamisen	166	Metal Piano	226	Crystal Sax	286	high Bagpipe
47	String Ensemble 1	107	Koto	167	Light rhythm Piano	227	Soft Baritone Sax	287	Bright Bagpipe
48	String Ensemble 2	108	Kalimba	168	electric Piano Pad	228	Synth Baritone Sax	288	Orchestra Bagpipe
49	Synth Strings 1	109	Bagpipe	169	Classical piano	229	Heavy metal Sax	289	Baritone Bagpipe
50	Synth Strings 2	110	Fiddle	170	Guitar organ	230	Church Oboe	290	Environmental Shanai
51	Choir Aahs	111	Shanai	171	An electric guitar	231	Bass Oboe	291	Baritone Shanai
52	Voice Oohs	112	Tinkle Bell	172	synthesis Nylon Guitar	232	Oboe ensemble	292	Tenor Shanai
53	Synth Voice	113	Agogo	173	Synthetic electronic guitar	233	Bright Oboe	293	high Shanai
54	Orchestra Hit	114	Steel Drums	174	Bright clean Guitar	234	distortio oboe	294	Synth Shanai
55	Trumpet	115	Woodblock	175	Orchestra Guitar	235	English Horn ensemble	295	Bright Steel Drums
56	Tuba	116	Taiko Drum	176	Psychedelic Guitar	236	Pizzicato English Horn	296	Steel Drums Lead
57	Muted Trumpet	117	Melodic Tom	177	Bright organ	237	Diplophonia English Horn	297	Lyric Steel Drums
58		118	Synth Drum	178	Pick organ	238	Bright English Horn	298	Orchestra Steel Drums
59		119	Reverse Cymbal	179	Synth accordion	239	Synth English Horn	299	Synth Steel Drums

### III. Basic operation method

#### Demo one

Press [Demo one] button to play song, and it can loop play next song automatically. Press [Demo one] button again, the play stops. Press [Demo one] button repeatedly, it will enter into next song play. The song can be chosen by pressing number buttons or +/- buttons.



#### Teaching function

Press [One key teaching] button or [Follow teaching] button to enter into teaching function, then, press number button or +/- button to choose different teaching songs. Press [One key teaching] button or [Follow teaching] button again, teaching function will exit. One Key Teaching: The correct sound will occur no matter the performance is right or wrong in learning, the song will continue to play, it is one key one note way.



Follow Teaching: Users can follow displaying to play correct notes, the play will enter into next note automatically if present performance is right. It is follow play.



### III. Basic operation method

#### 4. Keyboard split

Press [Keyboard Split] button in normal state to enter the double keyboard mode, the keyboard was divided into left and right two separate keyboards from 24th keys in left, The right hand keyboard tones can be adjusted by pressing number buttons, 24 pcs keys tones are pre-setting tones in left hand keyboard.

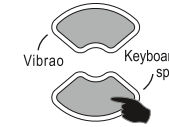

#### 5. Tempo adjustment

Press [Tempo +/-] button to adjust the play tempo of rhythm, metronome and demo, there are 210 pcs segments in total. The adjustment range is 30-240. Press [Tempo +/-] button again, it recovers tempo default value 120.

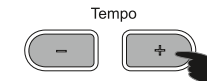

#### 6. Transpose

Press [Transpose +/-] button, the corresponding musical scale goes up or goes down for one note when you play with black and white keys. You can adjust the musical scale for 6 levels upwards and downwards. The system will recover the default keyboard tone automatically if you press [Transpose +/-] button at the same time.

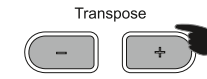

#### 7. Touch

The touch keyboard state was set for open automatically when power is on, The touch marking goes out (it means that the non touch keyboard was set) by pressing [Touch] button, Press [Touch] button again, the touch marking lights in LCD (it means that there is touch response).

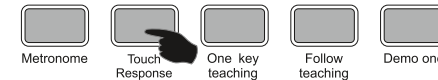

#### 8. Metronome

Press [Metronome] button, the tick-tock beat sound will occur. There are 4 kinds of beats for choice. The metronome effect will be added in performance. Everytime you press [Metronome] button, the function is: 1/4 beat, 2/4 beat, 3/4 beat, 4/4 beat. Pressing [Metronome] button to exit metronome function if tempo value displays at present.

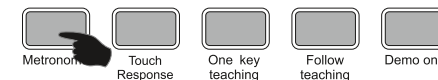

#### Panel percussion

Press panel percussion buttons (there are 8 kinds of panel percussion in total), the corresponding percussion can occur. You can fill in the corresponding percussion to enhance the performance effect based on your requirement.

#### Panel percussion list

Bass Drum1	Side Stick	Acoustic Snare	Hand Clap	Crash Cymbal 1	Tambourine	High Timpani	Claves



## III. Basic operation method

### Rhythm and relative rhythm function

#### 1. Rhythm selection

The keyboard has 300 kinds of rhythm for your choice. For detailed rhythm, please refer Appendix II-Rhythm List. Press [Rhythm] button to enter rhythm selection function, LCD displays current rhythm no., You also can choose rhythm by choosing number 0-9 and inputting numbers or by [+/-] buttons.

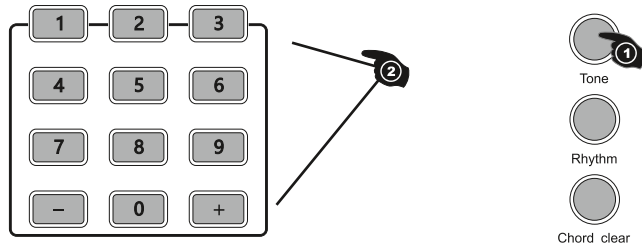

#### 2. Start/stop function

Pressing [Start/Stop] button to play rhythm, and pressing this button again to exit the function.



#### 3. Sync function

Pressing [Sync] button to start sync accompaniment function, pressing 19 pcs keys in left hand to start rhythm synchronously. If chord function has started, pressing the corresponding key in 19 keys of chord area, the auto chord will start synchronously. If the previous rhythm is being played, pressing this button to stop rhythm and start sync accompaniment function. If sync function has been started, pressing [Sync] button to exit this function.



#### 4. Intro/ending

Pressing [Intro/Ending] button before rhythm was started, this keyboard will play a length of relative intro, then, returns back to relative normal rhythm. Pressing this button after rhythm was started, the keyboard will play a length of relative ending to stop.



#### 5. Accompaniment volume adjustment

This keyboard has 9(0-8) levels accompaniment volume in total, the default accompaniment volume is 07. Pressing [Accomp Volume +/-] button to adjust volume. LCD has relative display when volume was adjusted. Pressing this button at the same time, the system will recover default accompaniment volume automatically.

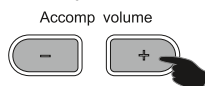

## III. Basic operation method

### Chord accompaniment

#### 1. Single chord

Press [Single chord] button under rhythm started state to enter single single auto chord function. Press different fingering in 1-19 keys of chord keyboard area at this time, you can hear different chord accompaniment. Press [Start/Stop] button to exit single chord.



#### 2. Finger chord

Press [Finger Chord] button under rhythm started state to enter finger auto bass chord function. Press different fingering in 1-19 keys of chord keyboard area, you can hear different chord accompaniment. Pressing [Start/Stop] button to exit finger chord.



#### 3. Chord clear

Press [Chord Clear] button after chord was started, the chord accompaniment sound stops, the rhythm continues to play.



#### 4. Chord volume

The default chord volume is "07", Press [Chord Volume +/-] button, 9(0-8) levels chord volume can be adjusted. The LCD has relative display when the volume was adjusted. Press this button again at the same time, the system will recover default chord volume automatically.

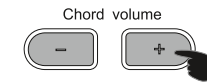

### Record function

1. Press [Record] button to enter record mode. Press any key or drums sound buttons can start record at this time. The maximum record quantity is 120 pcs notes.

When the record is full, the LCD displays "FULL", the next note can't be recorded continuously. The previous memory will be cleared and new record will start when you press keys in record state.

2. Press [Play] button, the recorded notes can be played.

3. Press [Program] button to enter into rhythm programming mode, Pressing 8 kinds of panel percussion or keyboard to program a paragraph of rhythm. This edited rhythm can record 32 pcs drum points at the most. Pressing [Play] button to play the edited drum sound in sequence, forming a kind of self-made rhythms after programming was finished. The best rhythm play effect can be get by adjusting [Temp +/-] buttons. Everytime, you press [Program] button, it will clear last memory and enter into programming mode again.





## X-Keyboardständer einstrebig

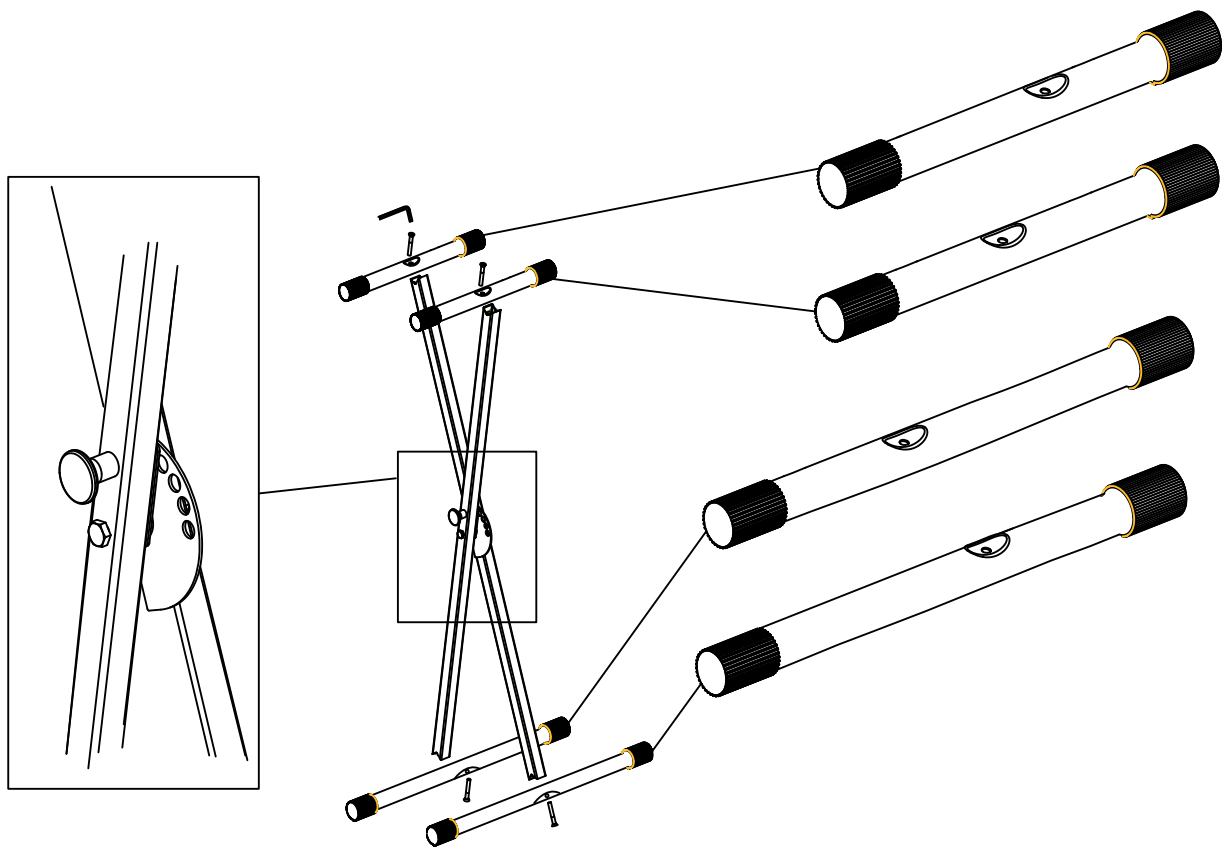

 **KIRSTEIN.de**  
We love music!

Musikhaus Kirstein GmbH  
Bernbeurener Str. 11  
86956 Schongau  
[www.kirstein.de](http://www.kirstein.de)

Art. 00009812 /00062730  
Version 10/2019