

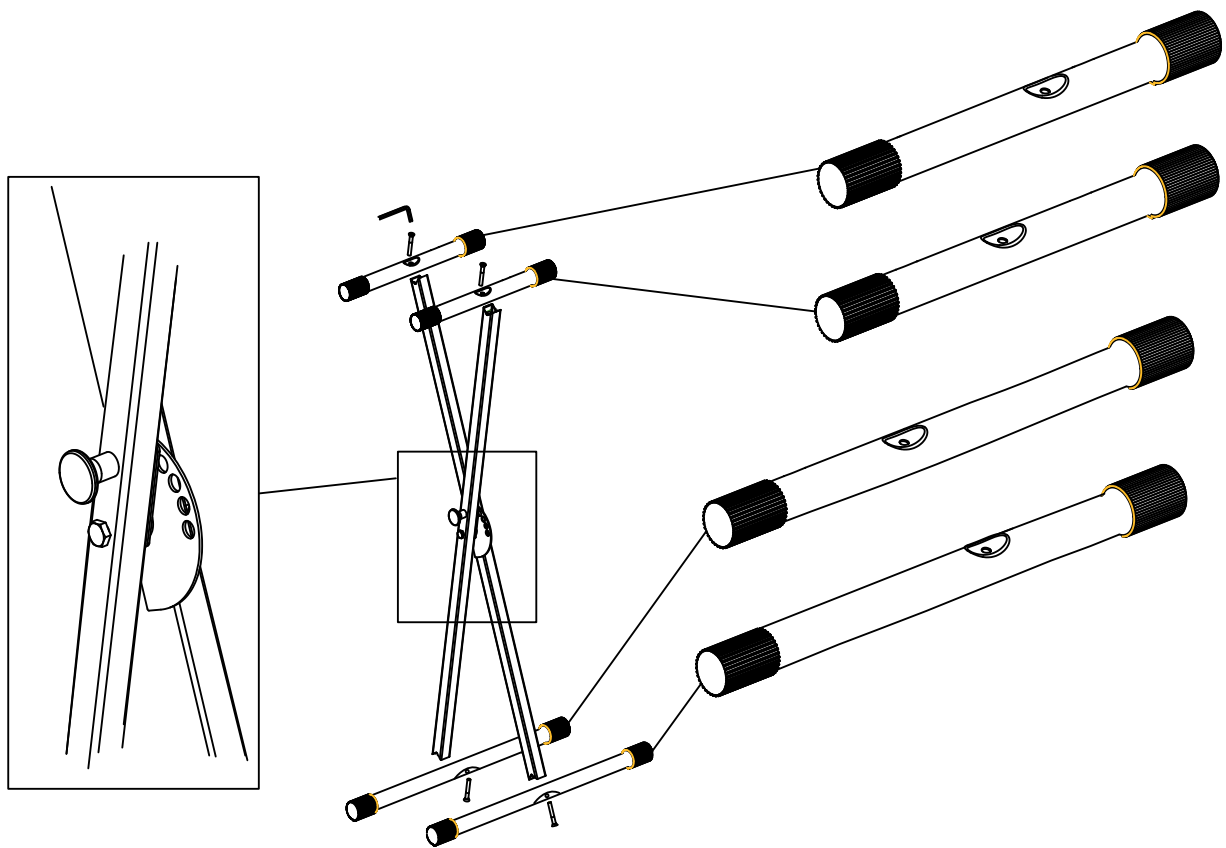

X-Keyboardständer einstrebig



 **KIRSTEIN.de**
We love music!

Musikhaus Kirstein GmbH
Bernbeurener Str. 11
86956 Schongau
www.kirstein.de

Art. 00009812 /00062730
Version 10/2019



KH-10

VORSICHTSMASSNAHMEN (BITTE SORGFÄLTIG DURCHLESEN). Kinder sollten beaufsichtigt werden, um sicherzustellen, dass sie dieses Produkt nicht als Spielzeug verwenden. Lassen Sie Kinder niemals unbeaufsichtigt mit dem Verpackungsmaterial spielen. Warnhinweise: Lesen Sie diese Anweisungen und bewahren Sie diese Anleitung auf. Verwenden Sie dieses Gerät nicht im Wasser. Vorsichtsmaßnahmen: Um Schäden am Produkt zu vermeiden, bringen Sie es nicht an Plätze mit hohen Temperaturen oder viel Staub, sehr niedriger oder hoher Luftfeuchtigkeit, legen Sie es nicht direkt neben eine Klimaanlage und vermeiden Sie direkte Sonneneinstrahlung. Wenden Sie im Umgang mit dem Produkt keinerlei Gewalt an. Ort: Setzen Sie das Produkt nicht den folgenden Bedingungen aus, um Verformungen, Verfärbungen oder größere Schäden zu vermeiden: Direktes Sonnenlicht, extreme Temperatur oder Luftfeuchtigkeit, übermäßig staubiger oder schmutziger Ort. Reinigung: Reinigen Sie das Produkt nur mit einem weichen, trockenen Tuch. Verwenden Sie keine Farbverdünner, Lösungsmittel, Reinigungsflüssigkeiten oder chemisch imprägnierte Wischtücher. Technische Änderungen und Änderungen im Erscheinungsbild sind vorbehalten. Alle Angaben entsprechen dem Stand bei Drucklegung. Für die Richtigkeit und Vollständigkeit der enthaltenen Beschreibungen, Abbildungen und Angaben übernimmt Musikhaus Kirstein GmbH keinerlei Gewähr. Abgebildete Farben und Spezifikationen können geringfügig vom Produkt abweichen. Musikhaus Kirstein GmbH - Produkte sind nur über autorisierte Händler erhältlich. Distributoren und Händler sind keine Handlungsbevollmächtigten von Musikhaus Kirstein GmbH und haben keinerlei Befugnis, die Musikhaus Kirstein GmbH in irgendeiner Weise, sei es ausdrücklich oder durch schlüssiges Handeln, rechtlich zu binden. Diese Bedienungsanleitung ist urheberrechtlich geschützt. Jede Vervielfältigung, bzw. jeder Nachdruck, auch auszugsweise, und jede Wiedergabe der Abbildungen, auch in verändertem Zustand, ist nur mit schriftlicher Zustimmung der Firma Musikhaus Kirstein GmbH gestattet.

WARNUNG: Achten Sie auf eine angemessene Lautstärke! Hören mit zu hohem Lautstärkepegel kann Ihr Gehör dauerhaft schädigen!



FUNKTION UND HANDHABUNG Der Kopfhörer kann mit allen handelsüblichen Abspielgeräten, wie CD-Playern, Stereoanlagen, mobilen Musik-Playern verwendet werden, welche über einen Kopfhörerausgang mit 3,5mm Stereo-Klinke verfügen. Sollte Ihre Soundquelle mit einem Kopfhörerausgang mit 6,3mm Stereo-Klinke ausgestattet sein, nutzen Sie den mitgelieferten Adapter (6,3mm zu 3,5mm Stereoklinkenbuchse).

WARTUNG: Ihr Gerät erfordert keine besondere Wartung. Wenden Sie sich im Falle einer Fehlfunktion an ein zugelassenes Servicecenter oder direkt an den Hersteller.

REINIGUNG: Verwenden Sie zur Reinigung ein fusselfreies, trockenes oder nur leicht angefeuchtetes Tuch.

TECHNISCHE DATEN: System: dynamischer Kopfhörer Stereo, Nennimpedanz: 32Ohm +/- 10%, Frequenzbereich: 20-20000Hz, Empfindlichkeit: 103dB S.P.L. bei 1kHz +/- 2%

WEEE-Erklärung (Waste of Electrical and Electronic Equipment) Ihr Produkt wurde unter Verwendung hochwertiger Materialien und Komponenten entwickelt und hergestellt, die recycelbar und wiederverwendbar sind. Dieses Symbol bedeutet, dass elektrische und elektronische Geräte am Ende ihrer Lebensdauer vom Hausmüll getrennt entsorgt werden müssen. Bitte entsorgen Sie dieses Gerät bei Ihrer örtlichen kommunalen Sammelstelle oder im Recycling-Center. Bitte helfen Sie mit, die Umwelt zu schützen, in der wir alle leben.



Musikhaus Kirstein GmbH, Bernbeurener Strasse 11, 86956 Schongau, Germany, [Tel:08861-909494-0](tel:08861-909494-0), info@kirstein.de



KH-10

PRECAUTIONS (PLEASE READ CAREFULLY). Children should be supervised to ensure that they do not use this product as a toy. Never allow children to play with the packaging material unsupervised. Warnings: Read these instructions and keep these instructions in a safe place. Do not use this appliance in water. Precautions: To avoid damage to the product, do not place it in places with high temperatures or a lot of dust, very low or high humidity, do not place it directly next to an air conditioner and avoid direct sunlight. Do not use force when handling the product. Location: Do not expose the product to the following conditions to avoid deformation, discoloration or major damage: Direct sunlight, extreme temperature or humidity, excessively dusty or dirty place. Cleaning: Only clean the product with a soft, dry cloth. Do not use paint thinners, solvents, cleaning fluids or chemically impregnated wiping cloths. We reserve the right to make technical changes and changes in appearance. All information is correct at the time of printing. Musikhaus Kirstein GmbH accepts no liability for the accuracy and completeness of the descriptions, illustrations and information contained herein. Colors and specifications shown may differ slightly from the product. Musikhaus Kirstein GmbH products are only available through authorized dealers. Distributors and dealers are not authorized agents of Musikhaus Kirstein GmbH and have no authority to legally bind Musikhaus Kirstein GmbH in any way, whether expressly or by implication. These operating instructions are protected by copyright. Any duplication or reprinting, even in part, and any reproduction of the illustrations, even in modified form, is only permitted with the written consent of Musikhaus Kirstein GmbH.

WARNING: Ensure an appropriate volume level! Listening at too high a volume level can permanently damage your hearing!



FUNCTION AND HANDLING The headphones can be used with all commercially available playback devices such as CD players, stereo systems and mobile music players that have a headphone output with a 3.5mm stereo jack. If your sound source is equipped with a headphone output with a 6.3 mm stereo jack, use the supplied adapter (6.3 mm to 3.5 mm stereo jack).

MAINTENANCE: Your appliance does not require any special maintenance. In the event of a malfunction, contact an approved service center or the manufacturer directly.

CLEANING: Use a lint-free, dry or slightly damp cloth for cleaning.

TECHNICAL DATA: System: dynamic stereo headphones, nominal impedance: 32Ohm +/- 10%, frequency range: 20-20000Hz, sensitivity: 103dB S.P.L. at 1kHz +/- 2%

WEEE declaration (Waste of Electrical and Electronic Equipment) Your product has been developed and manufactured using high-quality materials and components that are recyclable and reusable. This symbol means that electrical and electronic equipment must be disposed of separately from household waste at the end of its life. Please dispose of this appliance at your local municipal collection point or recycling center. Please help to protect the environment in which we all live.



LK 6120 MIC



User Manual

Version: 09/2019

© 2019

This manual is protected by copyright. Any copying or reprint, even in excerpts, is only allowed with written consent of Musikhaus Kirstein GmbH. The same applies to reproduction or copying of images, even in altered form.

Contents

1. Panel Control	1
2. External Ports	1
3. Performance Preparation	2
Battery mode	2
Operation via power supply	2
4. Audio output and headphone jack	2
Audio Out	2
Headphone jack	2
5. Audio input and microphone connection	2
Audio input	2
Microphone jack	3
6. Basic operation	3
Light key function	3
Volume Adjustment / Master Volume	3
Volume Adjustment / Accompaniment Volume	3
Select voice / timbre	3
Percussion Mode	3
Play demo songs	4
7. Accompaniment function (rhythm only)	4
Select rhythm	4
Playing with rhythm	4
Fill-In	4

Stop rhythm.....	4
Metronome.....	4
Adjust Tempo.....	4
8. Accompaniment function (chord mode)	4
Single Chord	4
Fingered Chord	5
9. Memory function.....	6
10. Effects.....	6
Transpose function.....	6
Sustain function.....	6
Vibrato function	6
Split function	6
11. Recording function	6
12. Rhythm programming	7
13. Learning function with illuminated keys	7
APPENDIX	9
Timbre.....	9
Rhythm	10
WEEE Declaration (Waste of Electrical and Electronic Equipment)	11

Thank you for purchasing this musical Instrument. To ensure you will be completely satisfied with this product, read and understand this manual carefully before use. Keep the manual in a safe place. The Operating Manual must be passed on to all subsequent users.



Follow the Operating Manual!



WARNING

The signal word **WARNING** identifies hazards, which can result without precautions in serious injury.



NOTE

The signal word **NOTE** indicates general precautions, which should be observed in handling the product.



NOTE

Images used in this manual may differ slightly from the actual product, as long as it has no adverse effect on the properties and safety of the product.



NOTE

All personal formulations in these instructions are to be considered gender neutral.

These operating instructions apply to persons who have been supervised or instructed in the operation of the device by a person responsible for their safety and who have proven to be able to handle the device.



WARNING

Children should be supervised to ensure that they do not use this item as a toy. Do not leave the children unattended. Never let children play with Plastic Bags or other material from packaging.



WARNING

Danger of property damage! We are not liable for accidents that occur as a result of non-observance of the safety instructions or due to incorrect handling.

All information contained in this Operating Manual is accurate to the best of our knowledge and belief. Neither the author nor the publisher, however, can be held liable for damages or losses that arise in connection with the use of this Operating Manual.

Other product, brand or company designations specified in this document are possibly the trademarks of their respective owners. Compliance with all applicable copyright laws is the responsibility of the user of this document.

 **WARNING**

Attention

Please observe the following basic information in order not to endanger yourself or others and to avoid damage on external equipment.

 **NOTE**

Warnings

Do not disassemble the instrument and do not modify it.

This could result in electric shock. Entrust a specialist workshop with any necessary service and maintenance or contact your dealer.

If you notice that the power cord shows signs of wear and tear, the unit has a malfunction, smells or smells burned, unplug it immediately, and then have a technician repair it

Before you clean the instrument, you should disconnect it from the power.

Always place the instrument on a flat, stable surface to prevent it from wobbling or falling over.

Do not use the instrument in a damp or wet environment.

Do not place vessels filled with liquids, such as vases, glasses or bottles on top of the instrument.

Do not place small objects on it that could slip in, such as hairpins, sewing needles or coins.

Do not place burning candles on the instrument.

 **NOTE**

Precautions

To avoid damaging the instrument, do not place it in places with high temperatures or dust, do not place it next to an air conditioner and avoid direct sunlight.

Do not place the instrument near other electrical equipment to avoid interference.

Do not use force when handling the instrument and avoid placing heavy objects on the unit.

Disconnect the instrument from the power if you are not going to use it for a long time.

To disconnect the device from the mains, pull the plug, not the cable.

Please handle the power cable carefully. It should not be near radiators, you should not place heavy objects on it and lay it in a way that people can not step on it or fall over it.

Please note that continuous high volume can permanently damage your hearing.

Adjust the volume carefully.

1. Panel Control

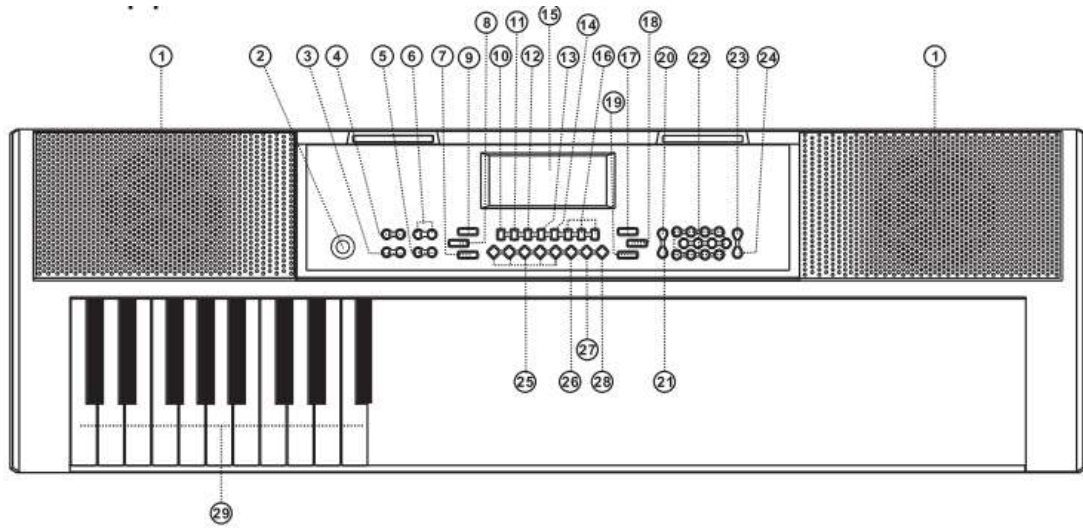

- | | | | |
|-----------------|---------------------------|-----------------------|----------------|
| ① Loudspeaker | ⑩ Single | ⑲ Keyboard Percussion | ⑳ KEY LIGHTING |
| ② Power On/Off | ⑪ Fingered | ⑳ Sustain | ㉑ Chord Zone |
| ③ Transpose | ⑫ Record | ㉒ Vibrato | |
| ④ Master Volume | ⑬ Programming | ㉓ Numbers | |
| ⑤ Tempo | ⑭ Play | ㉔ Timbre | |
| ⑥ Accom Volume | ⑮ LED Display | ㉕ Rhythm | |
| ⑦ Start/Stop | ⑯ One-key\Follow\Ensemble | ㉖ Memory M1-M4 | |
| ⑧ Fill-in | ⑰ Demo all | ㉗ Metronome | |
| ⑨ Sync | ⑱ Demo one | ㉘ Split | |

2. External Ports

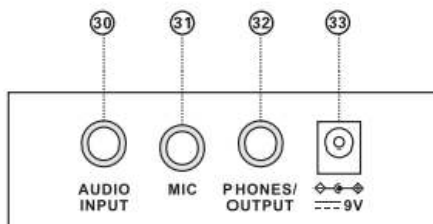

- | | |
|----|---------------|
| ③① | AUDIO INPUT |
| ③② | MIC |
| ③③ | PHONES/OUTPUT |
| ③④ | DC 9V |

This portable device is designed for indoor use. The warranty does not apply to equipment used for professional use.

3. Performance Preparation

Battery mode:

The instrument requires six 1.5V AA batteries. Open the battery compartment cover on the bottom and insert the batteries one after the other with the correct polarity. Replace the cover when the batteries are installed. (Batteries are not included.)

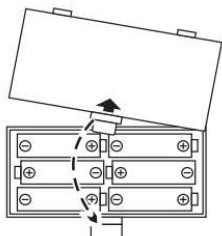

Energy or voltage losses lead to loss of volume and distortion. Discharged or bad batteries **MUST** be replaced immediately to ensure performance. Always remove the batteries if you are not going to use the product for a long time.

Operation via power supply

Use only the supplied AC adapter. Connect the output cable of the adapter to the power connector on the back of the instrument and the other end to the power outlet. (Note: The input voltage of the adapter must be compatible with the mains voltage.)

4. Audio output and headphone jack

Audio Out: Turn off the keyboard and the external audio device. Connect one end of an audio cable (optional) to the PHONES / OUTPUT connector on the back of the keyboard, and then connect the other end to the audio input of the audio device.

Headphone jack: When you connect headphones to the PHONES / OUTPUT jack on the back of the instrument, the speaker automatically turns off. In this way, you can practice without disturbing others.

 **WARNING**

When using headphones, please ensure suitable volume and practice time to prevent hearing damage.

5. Audio input and microphone connection

Audio input: The keyboard is equipped with a stereo input function. Sound from mobile phones, MP3 players, computers and other audio devices can be transmitted to the instrument. First, turn off the keyboard, connect one end of an audio cable (not supplied) to the output connector of an audio device, and the other end to the AUDIO INPUT connector on the back of the keyboard, and then turn on the keyboard.

Microphone jack: Connect the included microphone here to join in your performance.

 NOTE

Using a microphone may cause some noise such as hissing or feedback. Please keep the microphone at a reasonable distance from the speakers. It is recommended to unplug the microphone when not in use to avoid background noise.

6. Basic operation

Press the [POWER ON / OFF] button. The LED display turns on and displays the current tempo "120".

Light key function: This keyboard is equipped with a light key function. The light function is activated by default. Press [KEY LIGHTING] to enable or disable the light function.

Volume Adjustment / Master Volume: Press [MASTER VOL +] or [MASTER VOL -] to increase or decrease the overall volume. Press [MASTER VOL +] and [MASTER VOL -] simultaneously to restore the default value.

The overall volume setting also affects the accompaniment volume.

Volume Adjustment / Accompaniment Volume: Press [ACCOM VOL +] or [ACCOM VOL -] to increase or decrease the accompaniment volume. Press [ACCOM VOL +] and [ACCOM VOL -] simultaneously to restore the default value.

Select voice / timbre: Turning on the keyboard activates the voice selection function automatically. If you are in a different state, press the [TIMBRE] button to activate the voice selection function. The display shows "tnE". The voice is set to "000" by default and can now be changed by pressing the corresponding number buttons or by pressing the "+" / "-" buttons.

Percussion Mode: Press [Keyboard Percussion] to turn the keyboard into a percussion keyboard. In this mode, each key of the keyboard now corresponds to a percussion instrument. Press the [Keyboard Percussion] button again to disable the keyboard percussion function.

Play demo songs:

Press the [DEMO One] button. The keyboard now plays the current demo song repeatedly. Press the button again to play the next demo song.

Press the [DEMO All] button. The keyboard plays all demo songs one after another. During playback of a demo song, the voice (TIMBRE) can be changed.

7. Accompaniment function (rhythm only)

Select rhythm: Press the [Rhythm] button to activate the rhythm selection function. After "Rhy" appears in the display, press the number buttons or the "+" / "-" buttons to select other rhythms.

Playing with rhythm accompaniment: Press [START / STOP] to start the accompaniment rhythm. Alternatively, press [SYNC]. After "Syn" appears on the screen, play any key in the chord key zone (1st-19th key, from the left) to activate the rhythm accompaniment.

Fill-In: After the accompaniment rhythm has been activated, press [FILL-IN] to play a rhythm variation. If you hold down [FILL-IN], this variation will continue repeatedly.

Stop rhythm: During rhythm playback, press [START / STOP] to stop the accompaniment rhythm.

Metronome: The metronome supports different time signatures: 1/4, 2/4, 3/4 and 4/4. Press [Metronome] repeatedly to select one of the four time signatures. Press the [Metronome] button again to stop the metronome.































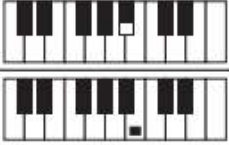

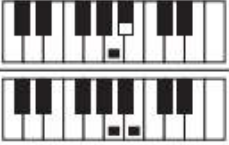
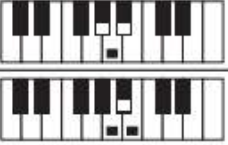
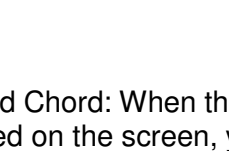
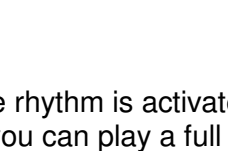
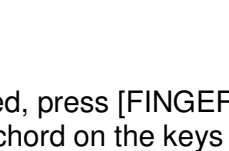
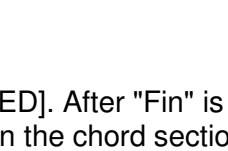
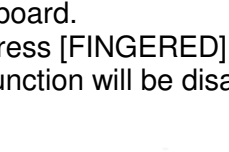
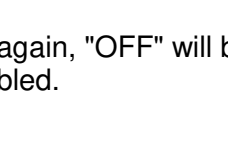
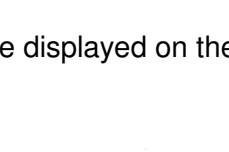
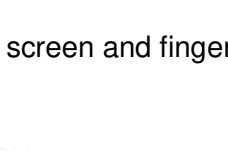



Adjust Tempo: Press [TEMPO +] or [TEMPO -] to increase or decrease the tempo. Simultaneously pressing the two buttons will restore the default setting.

8. Accompaniment function (chord mode)

Single Chord: When the rhythm is activated, press [SINGLE]. After "Sin" is displayed on the screen, the chords in the chord zone of the keyboard can be specified by the simplified single-finger mode.

Press [SINGLE] again. The screen will show "OFF" and disable the single-chord feature.

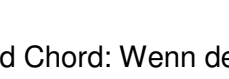
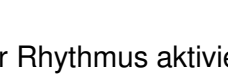
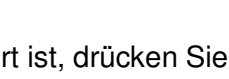
Single Chord Fingering

	M	m	7	m7
C				
C#				
D				
D#				
E				
F				
F#				
G				
G#				
A				
A#				
B				

Fingered Chord: When the rhythm is activated, press [FINGERED]. After "Fin" is displayed on the screen, you can play a full chord on the keys in the chord section of the keyboard.

If you press [FINGERED] again, "OFF" will be displayed on the screen and finger chord function will be disabled.

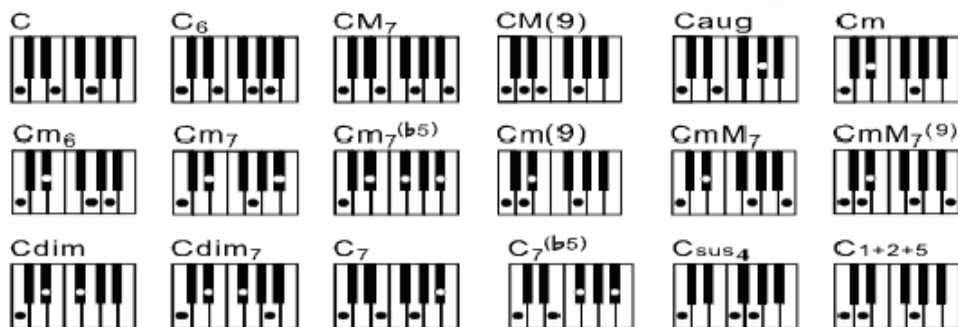

9. Memory function

The Direct Memory feature allows you to save the voice, rhythm, tempo, and other parameters that you want to change during playback for quick customization. This instrument is equipped with 3 direct memory buttons.

Set the instrument to the desired values, press the [Memory] button and select [Memory 1] to [Memory 4] to save the current status.

Press one of the [Memory 1] to [Memory 4] buttons to call up the setting parameters stored in this memory and replace the current status.

 NOTE
--

There is no permanent storage for the stored contents, and the stored contents are lost when the instrument is turned off.

10. Effects

Transpose function: The transpose function allows you to play music of other keys in C tuning. Press [Transpose -] to decrease the tone by one semitone (minor second). Press [Transpose +] to increase the tone by one semitone (minor second). If you press [Transpose-] several times, the tuning changes by a corresponding number of semitone steps. Press [Transpose +] and [Transpose -] at the same time to return to C tuning "00".

Sustain function: Press [Sustain], "SUS" will appear in the display and the sustain effect will be activated. Press this button again to deactivate the sustain effect.

Vibrato function: Press [Vibrato], the display will show "Vib" and the vibrato effect will be activated. Press this button again to deactivate the vibrato effect.

Split function: Press [SPLIT] to activate the split function. The display shows "ON". The 24 keys of the left half of the keyboard sound an octave higher. The voice of the left half of the keyboard remains the previously set voice. The remaining keys on the right side of the keyboard sound one octave lower to represent the same pitch as the left side.

If desired, the voice of the right half of the keyboard can be changed to reflect different voices on both halves of the keyboard.

Press [SPLIT] again to exit this function.

11. Recording function

Press the [REC] button to activate the recording function.

In this mode, all played notes are recorded. When the memory is full, "FUL" is displayed on the screen and recording stops automatically.

Press the [PLAY] button to play the recorded sounds for one time. The screen will show "PLY". When playback is complete, the recording mode is called up and "rEC" is displayed on the screen. You can now record again or press [PLAY] to replay the recorded sound.

Press [START / STOP] or [REC] again to deactivate the recording function. All recorded data will be lost.

 NOTE

There is no permanent memory for the stored contents, and the stored contents are lost when the instrument is turned off or the recording function is exited.

12. Rhythm programming

When the rhythm programming function is activated by pressing [PROG], "Prg" is displayed on the screen and keyboard percussion is activated. In this mode, you can create custom rhythms by playing the corresponding percussion keys.

A maximum of 32 percussion sounds can be recorded. Thereafter, "FUL" is displayed on the screen and programming is automatically stopped.

Press the [PLAY] button to play the recorded percussion. Pressing [PLAY] again to stop playback will display "Prg" on the screen and re-enable the programming function. You can now program a new rhythm or press the [PLAY] button again to restart the playback of the already recorded rhythm.

Press [START / STOP] or [PROG] again to deactivate the programming function. All recorded rhythms are lost as a result.

 NOTE

There is no permanent memory for the stored contents, and the stored contents are lost when the instrument is turned off or the programmer is left.

13. Learning function with illuminated keys

This instrument offers 3 learning modes: ONE KEY, FOLLOW and ENSEMBLE.

Press [One Key] to activate the single-key training function, then press the "+" / "-" button to select the song to be learned.

This training is aimed at learning the tone duration and timing, and there are no requirements for pitch or creativity. In this mode, pitch errors do not matter. No matter what tone is pressed, the right sound will always sound. The keyboard and display always show the correct notes.

After completing a song, repeat the currently-learning song.

Press [Start / Stop] or the [One Key] button to disable this training function.

Press [Follow] to activate the Follow function, then press the "+" / "-" button to select the song to learn.

This training [Follow] aims at learning the right pitch. Follow the tones shown on the display and through the illuminated keys on the keyboard. You must first play the correct note before the instrument continues to play.

In this condition, the keyboard only plays the correct notes and does not respond to the wrong notes.

Press [Start / Stop] or [Follow] to deactivate this training function.

Press [Ensemble] to activate the ensemble function, and then press the "+" / "-" button to select the song to be learned.

The ensemble training aims to learn the sound duration and pitch of the song properly. The melody note disappears. If you do not respond within 3 seconds, the keyboard automatically plays the correct note.

After completing a song, repeat the currently-learning song.

Press the [Start / Stop] or [Ensemble] button to disable this training function.

APPENDIX

Timbre

000 Acoustic Grand Piano	054 Clavi 1	107 Wood Barafon 1	161 Twin Trombones 1	215 Twin Trombones 2
001 Rhodes Piano	055 Glockenspiel 1	108 Electric Piano 1	162 Synth Harpsi. 2	216 Jazz Organ 2
002 Chorused Piano	056 Tubular Bells 1	109 Multi Reed 1	163 Attack Clav. 2	217 Bright String 2
003 Celesta 1	057 Dulcimer 1	110 Guitar Pinch 1	164 Chorus Guitar 1	218 Reed Horn 2
004 Music Box 1	058 Drawbar Organ 1	111 Multi Wind 1	165 Steel Bell 2	219 Glockenspiel 2
005 Vibraphone	059 Tango Accordion 1	112 Clavi 2	166 Tsugaru	220 Drawbar Organ 2
006 Marimba 1	060 Electric Guitar (Muted)1	113 Celesta 2	167 Oct Harp 1	221 Muted Horn 2
007 Xylophone 1	061 Overdriven Guitar 1	114 Harpsichord 2	168 Bodhran 1	222 Pizzicato Strings 2
008 Percussive Organ	062 Contrabass 1	115 Mellow Fm 1	169 Tubular Bells 2	223 Nay 2
009 Rock Organ	063 Tremolo Strings	116 Pi Pa 2	170 Suona	224 Puff Harmonica 2
010 Church Organ	064 Pizzicato Strings 1	117 Upright Piano 1	171 Castanets	225 Muted Trumpet 2
011 Reed Organ 1	065 Timpani	118 Electric Piano 2	172 Attack Harp 1	226 Upright Piano 2
012 Accordion	066 String Ensemble 2	119 Hard Vibe 1	173 Electric Vibraphone 1	227 Soft Accord 2
013 Harmonica	067 Synth Strings 1	120 Wood Barafon 2	174 Soft Sax 1	228 Uilleann Harp 2
014 Acoustic Guitar (Nylon)	068 Synth Strings 2	121 Music Box 2	175 Soft Clav. 1	229 Tron Flute 2
015 Acoustic Guitar (Steel)	069 Choir Aahs	122 Marimba 2	176 Soft Guitar 1	230 Blown Bottle 2
016 Electric Guitar (Jazz)	070 Voice Oohs	123 Santur	177 Grow Guitar 1	231 Indian Flute 2
017 Electric Guitar (Clean)1	071 Synth Voice	124 Reed Organ 2	178 Diddgeridoo 1	232 Slow Violin 2
018 Distortion Guitar	072 Orchestra Hit	125 Puff Harmonica 1	179 Attack Barafon 1	233 Electric Guitar (Muted)2
019 Acoustic Bass	073 Muted Trumpet 1	126 Ukulele 1	180 Mute Barafon 1	234 Multi Wind 2
020 Electric Bass (Finger)	074 Synth Brass 2	127 12-str. Gt 1	181 Nay 1	235 Electric Vibraphone 2
021 Electric Bass (Pick)	075 English Horn 1	128 Guitar Pinch 2	182 Soft Santur	236 Bodhran 2
022 Fretless Bass	076 Recorder	129 Slow Violin 1	183 Dual Horns 1	237 Mellow Fm 2
023 Slap Bass 1	077 Blown Bottle 1	130 Bright String 1	184 Hard Barsoon 1	238 Multi Reed 2
024 Slap Bass 2	078 Shakuhach	131 Jungle Bass 2	185 Tron Flute 1	239 Contrabass 2
025 Synth Bass 1	079 Whistle	132 Indian Flute 1	186 Kawala 1	240 Barafon 2
026 Synth Bass 2	080 Ocarina	133 Clavi 3	187 Jazz Organ 1	241 Wind Organ 2
027 Violin	081 Lead (Sawtooth)1	134 Celesta 3	188 Soft Accord 1	242 12-str. Gt 2
028 Viola	082 Lead (Calliope)1	135 Church Bells	189 Wind Organ 1	243 Attack Barafon 2
029 Cello	083 Lead (Bass+Lead)1	136 Marimba 3	190 Viola Attack 1	244 Lead (Calliope)2
030 Orchestral Harp	084 Pad (Warm)1	137 Dulcimer 2	191 Bari & Tenor 1	245 Viola Attack 2
031 String Ensemble 1	085 Sitar	138 Reed Organ 3	192 Soft Sax 2	246 Pad (Warm)2
032 Trumpet	086 Shamisen 1	139 Electric Guitar (Clean)2	193 Attack Harp 2	247 Oct Harp 2
033 Trombone	087 Koto 1	140 Koto 2	194 Diddgeridoo 2	248 Bari & Tenor 2
034 Tuba	088 Kalimba 1	141 Xylophone 2	195 Dual Horns 2	249 Agogo 2
035 French Horn	089 Bag Pipe 1	142 Shanai 2	196 Hard Barsoon 2	250 Flugel Horn 3
036 Brass Section	090 Fiddle 1	143 Dulcimer 3	197 Kawala 2	251 Organ Flute 3
037 Synth Brass 1	091 Shanai 1	144 English Horn 2	198 Soft Guitar 2	252 Fiddle 3
038 Soprano Sax	092 Tinkle Bell	145 Electric Guitar (Clean)3	199 Mute Barafon 2	253 Feedback Gt. 3
039 Alto Sax 1	093 Agogo 1	146 Shamisen 2	200 Lead (Bass+Lead)2	254 Chorus Guitar 3
040 Tenor Sax	094 Steel Drums	147 Koto 3	201 Melodic Tom 2	
041 Baritone Sax	095 Woodblock 1	148 Kalimba 2	202 Grow Guitar 2	
042 Oboe	096 Taiko Drum	149 Steel Bell 1	203 Lead (Sawtooth)2	
043 Bassoon	097 Melodic Tom 1	150 Alto Sax 2	204 Jazz Bass 2	
044 Clarinet	098 Synth Drum	151 Woodblock 2	205 Chorus Guitar 2	
045 Piccolo	099 Reverse Cymbal	152 Synth Harpsi. 1	206 Feedback Gt. 2	
046 Flute	100 Jungle Bass 1	153 Attack Clav. 1	207 Fiddle 2	
047 Pan Flute	101 Pi Pa 1	154 Crystal 1	208 Organ Flute 2	
048 Lead (Square)	102 Feedback Gt. 1	155 Bag Pipe 2	209 Flugel Horn 2	
049 Banjo	103 Uilleann Harp 1	156 Barafon 1	210 Crystal 2	
050 E-Tone Piano	104 Jazz Bass 1	157 Organ Flute 1	211 Soft Clav. 2	
051 Electric Grand Piano	105 Flugel Horn 1	158 Kalimba 3	212 Overdriven Guitar 2	
052 Honky-tonk Piano	106 Muted Horn 1	159 Reed Horn 1	213 Ukulele 2	
053 Harpsichord 1		160 Hard Vibe 2	214 Tango Accordion 2	

Rhythm

000 Hard Rock	051 China 2	102 Jazz Latin 1	153 Club Dance 1	204 Caribbean Dance 2
001 Club Pop	052 China 3	103 Unplugged	154 Tricks Bossa Nova	205 Jazz Disco 2
002 Fusion	053 China 4	104 Boogie	155 Tarantella 2	206 Medium Jazz
003 Rap Pop	054 China 5	105 Cumbia 2	156 USA March	207 Piano Ballad
004 British Pop 1	055 8 Bt Up Tempo	106 Classical Slow Rock	157 Espag Nol 2	208 70's Disco
005 Twist	056 16 Beat Pop	107 European Disco 1	158 Club Latin 2	209 Jazz Rock 2
006 8 Beat Pop 1	057 16 Bt Shuffle 1	108 Big Band Middle 1	159 Jazz Cha Cha 1	210 Europe 8 Beat 1
007 Fusion Shuffle	058 16 Bt Shuffle 2	109 Christon	160 Country Cha Cha	211 Seville 2
008 Funk	059 16 Bt Ballad 1	110 Pasodobl	161 Disco Party 2	212 Rumba 3
009 Funk Shuffle	060 16 Bt Ballad 2	111 Cat Groove 1	162 Modern R&B 1	213 Soul Rock 2
010 Rock'n Roll 1	061 Soul	112 Jazz Tango 1	163 8 Beat Pop 2	214 European Disco 2
011 Rock Pop	062 Pop Rock 1	113 Fast Gospel	164 Country Jazz	215 Analog Ballad 2
012 Rock Shuffle	063 Pop Rock 2	114 Big Band Fast 1	165 Soul Rock 1	216 Pub Piano 2
013 Rock Cha Cha	064 8 Bt Rock Balld	115 Tricks Mambo	166 Rumba 2	217 Europe Rumba
014 Straight Rock	065 16 Bt Rock Balld	116 Funky Disco 2	167 Samba 3	218 Rock'n Roll 2
015 Folk Rock	066 6/8 Hvy Rock	117 Latin Salsa	168 Modern R&B 2	219 Disco Trop
016 Pasodoble	067 16 Beat Rock	118 Pop New Age 2	169 Club Dance 2	220 Rock Salsa 1
017 Cha Cha	068 Bossa Nova 1	119 Jazz Swing 1	170 Country Bossa Nova	221 Europe 8 Beat 2
018 Fox Trot	069 Bossa Nova 2	120 Trip Hop	171 Jazz Bo 1	222 Europe Samba
019 Rumba 1	070 Salsa	121 Rave 2	172 Modern Cha Cha 1	223 Show Tune 2
020 Samba 1	071 Mambo	122 Acoustic Ballad 1	173 Pop Reggae 2	224 Jazz 16 Beat 2
021 Samba 2	072 Beguine	123 India's Indigenous	174 Rock Samba 1	225 Rock Samba 2
022 Schlager Rock	073 Bolero Lento	124 Indonesian Pop	175 Jazz 8 Beat 1	226 Jazz Waltz 2
023 Tango 1	074 Espagnole	125 Pop Ballad	176 Disco	227 Europe Reggae
024 Tango 2	075 Reggae 12	126 South Africa Country	177 Seville 1	228 Modern Cha Cha 2
025 Disco Latin 1	076 Pop Reggae 1	127 South Africa Polka	178 Disco Hands 2	229 R&B Ballad 2
026 Calypso	077 Slow Rock 1	128 Tarantella 1	179 Rock Ballad	230 Rock Boogie
027 Latin Rock	078 Slow Rock 2	129 Bright Pop	180 Mixed Bossa Nova	231 Jazz Bossa Nova
028 Bolero	079 R&B	130 Pub Piano 1	181 Jazz 16 Beat 1	232 Rock Salsa 2
029 Analog Ballad 1	080 Dance Pop 1	131 West Shuffle	182 Single 16 Beat 1	233 Slow & Easy
030 E_Ballad	081 Dance Pop 2	132 Big Band Fast 2	183 Love Song	234 Hip Waltz 1
031 Country Ballad	082 Euro Beat	133 Espag Nol 1	184 Single 16 Beat 2	235 Jazz Latin 2
032 Electro Pop	083 Euro House	134 Disco Funk 2	185 Disco Fox 2	236 Rock Disco 2
033 Pop New Age 1	084 Hip Hop	135 Pop Mambo	186 Pop Rock 3	237 Jazz Tango 2
034 8 Beat Modern 1	085 Swing	136 Europe Swing 1	187 Tijuana Waltz	238 Analog Ballad 3
035 R&B Ballad 1	086 Big Band Swing	137 Tricks Latin	188 British Pop 2	239 Europe Swing 2
036 Disco Fox 1	087 Jazz Quartet	138 Disco Samba 2	189 Show Tune 1	240 Hip Waltz 2
037 Disco Funk 1	088 Dixieland	139 Latin Waltz	190 Schlager Alp	241 Jazz Swing 2
038 Disco Party 1	089 Bluegrass 1	140 Dance Pop 3	191 Single Rock	242 Party Pop
039 Disco Samba 1	090 Bluegrass 2	141 Jazz Rock 1	192 Swing Waltz	243 Jazz Club
040 Disco Soul	091 8 Bt Country	142 Detroit	193 Slow Waltz	244 Guad Dance 2
041 Disco Trot	092 Country Rock	143 Fanatical Sand	194 Cat Groove 2	245 Jazz Bo 2
042 Rave 1	093 Cntry Ballad	144 European Rock 1	195 Country Slow Rock	246 Dixie Jazz 2
043 Funky Disco 1	094 March 1	145 Ground Beat	196 Rock Disco 1	247 Acoustic Ballad 2
044 Techno 1	095 March 2	146 8 Beat Modern 2	197 16 Beat Shuffle 1	248 Jazz Slow Rock
045 Techno 2	096 Polka	147 Jazz Disco 1	198 Jazz 8 Beat 2	249 16 Beat Shuffle 2
046 Saturday Night 1	097 Pop Waltz	148 Dixie Jazz 1	199 Casa	250 Polka Pop
047 Club Latin 1	098 Jive	149 Disco Chocolate	200 Guad Dance 1	251 Latin Party Pop
048 Disco Hands 1	099 Vienna Waltz	150 Disco Latin 2	201 Jazz Cha Cha 2	252 Parranda
049 Country	100 8 Beat Soul	151 Synth Boogie	202 Country Waltz	253 Carnival
050 China 1	101 Classical 8 Beat	152 Saturday Night 2	203 European Rock 2	254 60's Vintage Pop

WEEE Declaration (Waste of Electrical and Electronic Equipment)

Your product has been designed and manufactured using quality materials and components that are recyclable and reusable. The symbol means that your product must be disposed separately from household waste at the end of its service life.

Dispose of this equipment at your local collection point or recycling center.

Please help to protect the environment in which we all live.

All specifications and appearances are subject to change without notice. All information was correct at time of printing. Musikhaus Kirstein GmbH does not guarantee for the accuracy or completeness of any description, photograph or statement contained in this manual. Printed colors and specifications may vary slightly from product. Products from Musikhaus Kirstein GmbH are only sold through authorized dealer. Distributors and dealers are not agents of Musikhaus Kirstein GmbH and have no authority to bind Musikhaus Kirstein GmbH legally in any way.

 **KIRSTEIN.de**

Musikhaus Kirstein GmbH

Bernbeurener Str. 11

86956 Schongau – Germany

Telefon/Phone: 0049-8861-909494-0

Telefax/Fax: 0049-8861-909494-19

