



KH-10

VORSICHTSMASSNAHMEN (BITTE SORGFÄLTIG DURCHLESEN). Kinder sollten beaufsichtigt werden, um sicherzustellen, dass sie dieses Produkt nicht als Spielzeug verwenden. Lassen Sie Kinder niemals unbeaufsichtigt mit dem Verpackungsmaterial spielen. Warnhinweise: Lesen Sie diese Anweisungen und bewahren Sie diese Anleitung auf. Verwenden Sie dieses Gerät nicht im Wasser. Vorsichtsmaßnahmen: Um Schäden am Produkt zu vermeiden, bringen Sie es nicht an Plätze mit hohen Temperaturen oder viel Staub, sehr niedriger oder hoher Luftfeuchtigkeit, legen Sie es nicht direkt neben eine Klimaanlage und vermeiden Sie direkte Sonneneinstrahlung. Wenden Sie im Umgang mit dem Produkt keinerlei Gewalt an. Ort: Setzen Sie das Produkt nicht den folgenden Bedingungen aus, um Verformungen, Verfärbungen oder größere Schäden zu vermeiden: Direktes Sonnenlicht, extreme Temperatur oder Luftfeuchtigkeit, übermäßig staubiger oder schmutziger Ort. Reinigung: Reinigen Sie das Produkt nur mit einem weichen, trockenen Tuch. Verwenden Sie keine Farbverdünner, Lösungsmittel, Reinigungsflüssigkeiten oder chemisch imprägnierte Wischtücher. Technische Änderungen und Änderungen im Erscheinungsbild sind vorbehalten. Alle Angaben entsprechen dem Stand bei Drucklegung. Für die Richtigkeit und Vollständigkeit der enthaltenen Beschreibungen, Abbildungen und Angaben übernimmt Musikhaus Kirstein GmbH keinerlei Gewähr. Abgebildete Farben und Spezifikationen können geringfügig vom Produkt abweichen. Musikhaus Kirstein GmbH - Produkte sind nur über autorisierte Händler erhältlich. Distributoren und Händler sind keine Handlungsbevollmächtigten von Musikhaus Kirstein GmbH und haben keinerlei Befugnis, die Musikhaus Kirstein GmbH in irgendeiner Weise, sei es ausdrücklich oder durch schlüssiges Handeln, rechtlich zu binden. Diese Bedienungsanleitung ist urheberrechtlich geschützt. Jede Vervielfältigung, bzw. jeder Nachdruck, auch auszugsweise, und jede Wiedergabe der Abbildungen, auch in verändertem Zustand, ist nur mit schriftlicher Zustimmung der Firma Musikhaus Kirstein GmbH gestattet.

WARNUNG: Achten Sie auf eine angemessene Lautstärke! Hören mit zu hohem Lautstärkepegel kann Ihr Gehör dauerhaft schädigen!



FUNKTION UND HANDHABUNG Der Kopfhörer kann mit allen handelsüblichen Abspielgeräten, wie CD-Playern, Stereoanlagen, mobilen Musik-Playern verwendet werden, welche über einen Kopfhörerausgang mit 3,5mm Stereo-Klinke verfügen. Sollte Ihre Soundquelle mit einem Kopfhörerausgang mit 6,3mm Stereo-Klinke ausgestattet sein, nutzen Sie den mitgelieferten Adapter (6,3mm zu 3,5mm Stereoklinkenbuchse).

WARTUNG: Ihr Gerät erfordert keine besondere Wartung. Wenden Sie sich im Falle einer Fehlfunktion an ein zugelassenes Servicecenter oder direkt an den Hersteller.

REINIGUNG: Verwenden Sie zur Reinigung ein fusselfreies, trockenes oder nur leicht angefeuchtetes Tuch.

TECHNISCHE DATEN: System: dynamischer Kopfhörer Stereo, Nennimpedanz: 32Ohm +/- 10%, Frequenzbereich: 20-20000Hz, Empfindlichkeit: 103dB S.P.L. bei 1kHz +/- 2%

WEEE-Erklärung (Waste of Electrical and Electronic Equipment) Ihr Produkt wurde unter Verwendung hochwertiger Materialien und Komponenten entwickelt und hergestellt, die recycelbar und wiederverwendbar sind. Dieses Symbol bedeutet, dass elektrische und elektronische Geräte am Ende ihrer Lebensdauer vom Hausmüll getrennt entsorgt werden müssen. Bitte entsorgen Sie dieses Gerät bei Ihrer örtlichen kommunalen Sammelstelle oder im Recycling-Center. Bitte helfen Sie mit, die Umwelt zu schützen, in der wir alle leben.



Musikhaus Kirstein GmbH, Bernbeurener Strasse 11, 86956 Schongau, Germany, [Tel:08861-909494-0](tel:08861-909494-0), info@kirstein.de



KH-10

PRECAUTIONS (PLEASE READ CAREFULLY). Children should be supervised to ensure that they do not use this product as a toy. Never allow children to play with the packaging material unsupervised. Warnings: Read these instructions and keep these instructions in a safe place. Do not use this appliance in water. Precautions: To avoid damage to the product, do not place it in places with high temperatures or a lot of dust, very low or high humidity, do not place it directly next to an air conditioner and avoid direct sunlight. Do not use force when handling the product. Location: Do not expose the product to the following conditions to avoid deformation, discoloration or major damage: Direct sunlight, extreme temperature or humidity, excessively dusty or dirty place. Cleaning: Only clean the product with a soft, dry cloth. Do not use paint thinners, solvents, cleaning fluids or chemically impregnated wiping cloths. We reserve the right to make technical changes and changes in appearance. All information is correct at the time of printing. Musikhaus Kirstein GmbH accepts no liability for the accuracy and completeness of the descriptions, illustrations and information contained herein. Colors and specifications shown may differ slightly from the product. Musikhaus Kirstein GmbH products are only available through authorized dealers. Distributors and dealers are not authorized agents of Musikhaus Kirstein GmbH and have no authority to legally bind Musikhaus Kirstein GmbH in any way, whether expressly or by implication. These operating instructions are protected by copyright. Any duplication or reprinting, even in part, and any reproduction of the illustrations, even in modified form, is only permitted with the written consent of Musikhaus Kirstein GmbH.

WARNING: Ensure an appropriate volume level! Listening at too high a volume level can permanently damage your hearing!



FUNCTION AND HANDLING The headphones can be used with all commercially available playback devices such as CD players, stereo systems and mobile music players that have a headphone output with a 3.5mm stereo jack. If your sound source is equipped with a headphone output with a 6.3 mm stereo jack, use the supplied adapter (6.3 mm to 3.5 mm stereo jack).

MAINTENANCE: Your appliance does not require any special maintenance. In the event of a malfunction, contact an approved service center or the manufacturer directly.

CLEANING: Use a lint-free, dry or slightly damp cloth for cleaning.

TECHNICAL DATA: System: dynamic stereo headphones, nominal impedance: 32Ohm +/- 10%, frequency range: 20-20000Hz, sensitivity: 103dB S.P.L. at 1kHz +/- 2%

WEEE declaration (Waste of Electrical and Electronic Equipment) Your product has been developed and manufactured using high-quality materials and components that are recyclable and reusable. This symbol means that electrical and electronic equipment must be disposed of separately from household waste at the end of its life. Please dispose of this appliance at your local municipal collection point or recycling center. Please help to protect the environment in which we all live.



Classic Cantabile

CPK-303

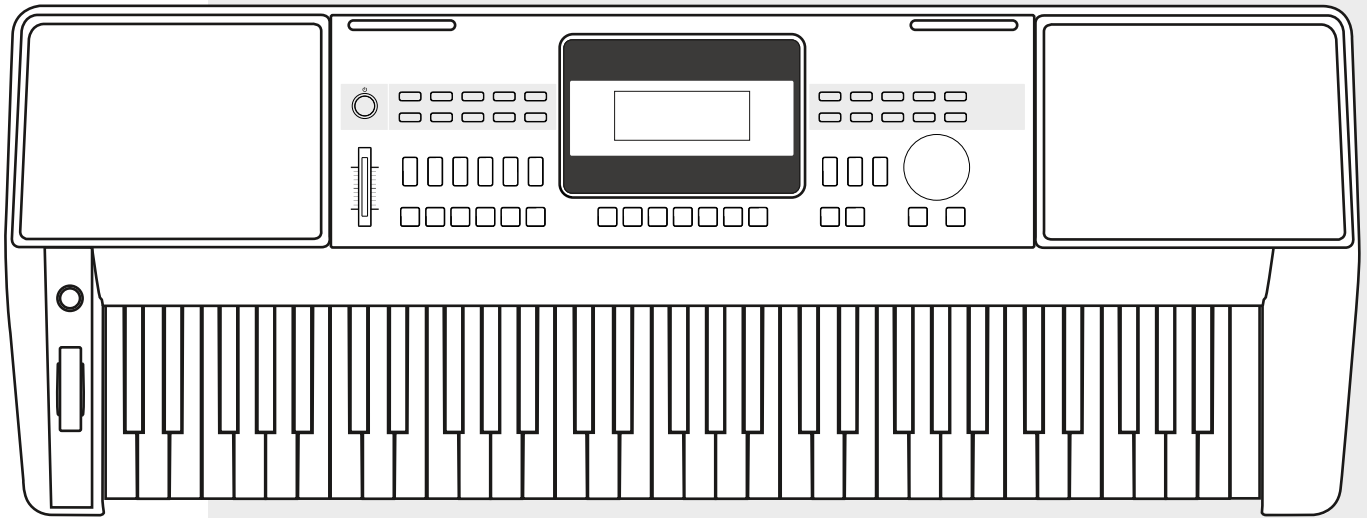

Owner's Manual

Version 07/2019

INFORMATION FOR YOUR SAFETY!

THE FCC REGULATION WARNING (for USA)

This equipment has been tested and found to comply with the limits for a Class B digital device, pursuant to Part 15 of the FCC Rules.

These limits are designed to provide reasonable protection against harmful interference in a residential installation. This equipment generates, uses, and can radiate radio frequency energy and, if not installed and used in accordance with the instructions, may cause harmful interference to radio communications. However, there is no guarantee that interference will not occur in a particular installation. If this equipment does cause harmful interference to radio or television reception, which can be determined by turning the equipment off and on, the user is encouraged to try to correct the interference by one or more of the following measures:

- Reorient or relocate the receiving antenna.
- Increase the separation between the equipment and receiver.
- Connect the equipment into an outlet on a circuit different from that to which the receiver is connected.
- Consult the dealer or an experienced radio/TV technician for help.

Unauthorized changes or modification to this system can void the user's authority to operate this equipment.

CAUTION

The normal function of the product may be disturbed by Strong Electro Magnetic Interference. If so, simply reset the product to resume normal operation by following the owner's manual. In case the function could not resume, please use the product in other location.

PRECAUTIONS

PLEASE READ CAREFULLY BEFORE PROCEEDING

Please keep this manual in a safe place for future reference.

Power Supply

Please connect the designated AC adaptor to an AC outlet of the correct voltage.

Do not connect it to an AC outlet of voltage other than that for which your instrument is intended.

Unplug the AC power adaptor when not using the instrument, or during electrical storms.

Connections

Before connecting the instrument to other devices, turn off the power to all units. This will help prevent malfunction and / or damage to other devices.

Location

Do not expose the instrument to the following conditions to avoid deformation, discoloration, or more serious damage:

- Direct sunlight
- Extreme temperature or humidity
- Excessive dusty or dirty location
- Strong vibrations or shocks
- Close to magnetic fields

Interference with other electrical devices

Radios and televisions placed nearby may experience reception interference. Operate this unit at a suitable distance from radios and televisions.

Cleaning

Clean only with a soft, dry cloth.

Do not use paint thinners, solvents, cleaning fluids, or chemical-impregnated wiping cloths.

Handling

Do not apply excessive force to the switches or controls.

Do not let paper, metallic, or other objects into the instrument. If this happens, unplug the AC adaptor from the wall outlet. Then have the instrument inspected by qualified service personnel.

Disconnect all cables before moving the instrument.

Panel & Display Description

Front Panel.....	4
Rear Panel.....	4
LCD.....	5

Setup

Power Supply.....	6
Setting a Music Stand.....	6

Connections

Connecting a pair of Headphones.....	7
Using Sustain Pedal.....	7
Connecting a Computer.....	7

Quick Start

Power/Master Volume

Turn the Power On/ Off.....	8
Adjust the Master Volume.....	8

Playing Demo Songs.....

Playing Voices.....

Playing Styles.....

Playing Songs.....

Record.....

Advanced Use

Voices

Select a Voice.....	11
Playing two voices simultaneously-DUAL.....	11
Playing Different Voices with Both hands-LOWER.....	11

Styles

Play Auto Accompaniment (rhythm track only).....	12
Play Auto Accompaniment(all tracks).....	12
Accompaniment Sections.....	12
Playing Different Accompaniment Sections.....	13
Fade.....	13
Accompaniment Volume Control.....	13
Chord Fingering.....	14
Tempo.....	15

Function Menu

Tune.....	16
Split Point.....	16
Beat Type.....	17
Pedal Type.....	17
EQ Type.....	17
Reverb Type.....	17
Reverb Level.....	18
Chorus Type.....	18
Chorus Level.....	18
Harmony Type.....	18
MIDI IN/ OUT.....	19
Auto Power Off.....	19

Mixer.....

Effect Related Settings

Octave.....	20
Touch.....	20
Metronome.....	20
Sustain.....	20
Pitch Bend.....	21
Modulation.....	21
DSP.....	21
Transpose.....	21
Harmony.....	21

Register Memory

Registration Banks.....	22
Registering the Panel Setting and Recalling the Registered Panel Settings.....	22
Store Parameters to M1-M4.....	22

One Touch Setting.....

Record

Prepare for Recording.....	23
Start Recording.....	23
Stop Recording.....	23
Playback Recording.....	24
Delete User Song.....	24

Playing the Demo Song.....

Piano Mode.....

Song

Listening to the Songs.....	25
Song Control.....	25
Lesson Mode.....	26

Chord Dictionary

DICT 1 (Chord Learning Mode).....	27
DICT 2 (Chord Examining Mode).....	27
Exit Chord Dictionary.....	27

Pedal Function

Multi-function Pedal.....	28
---------------------------	----

MIDI

What's MIDI?.....	29
The main application of MIDI.....	29

Troubleshooting.....

Specifications.....

Appendices

Voice List.....	31
Style List.....	36
Song List.....	38
Demo List.....	39
MIDI Implementation Chart.....	40

Panel & Display Description

Front Panel

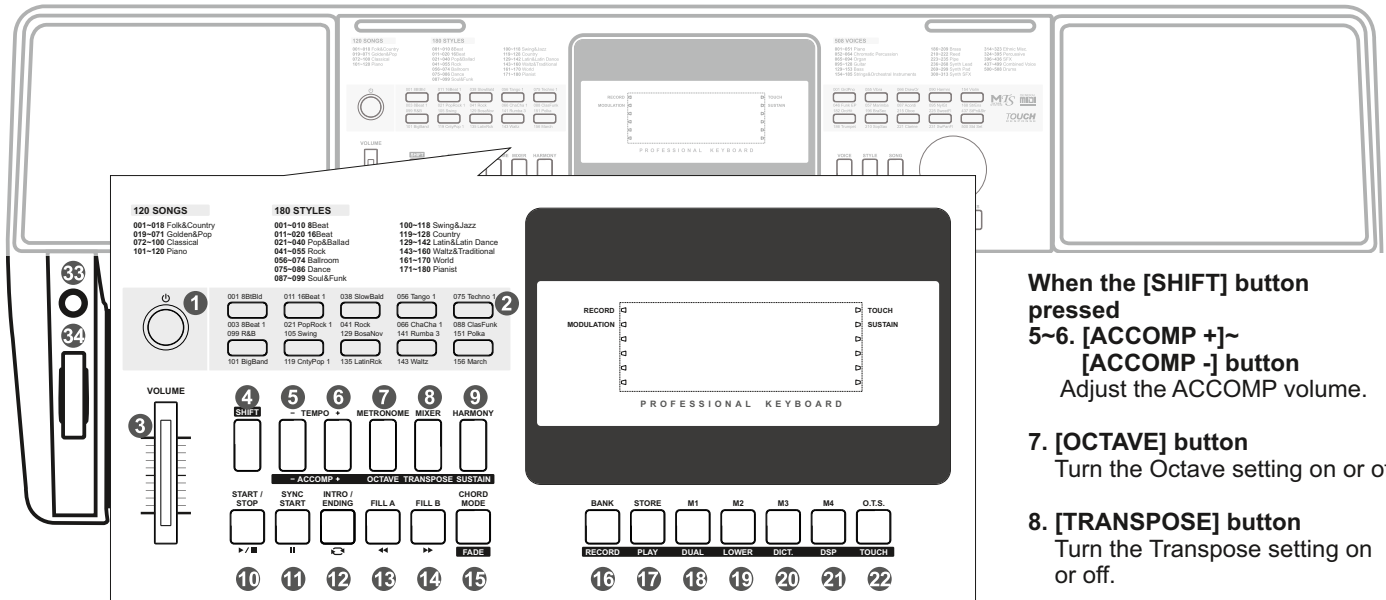

1. POWER SWITCH
Turn the Power on or off.

2. STYLE DIRECT SELECT BUTTON
Select a direct Style.

When the [SHIFT] button released
5~6. [TEMPO +]~ [TEMPO -] button
Adjust the current Tempo.

3. [VOLUME] Slider
Adjust the master Volume.

4. [SHIFT] button
Select the second function of some buttons.

7. [METRONOME] button
Turn the metronome on or off.

In Style Mode

10. [START/ STOP] button
Start or Stop playing the style.

11. [SYNC START] button
Turn the Sync Start on or off.

12. [INTRO/ ENDING] button
Play the Intro or Ending.

13. [FILL A] button
A Fill-in A plays.

14. [FILL B] button
A Fill-in B plays.

In Song Mode

10. [START/ STOP] button
Start or Stop playing the song.

11. [PAUSE] button
Pause or continue playing the song.

12. [REPEAT] button
Set the beginning and ending location of loop to the current song.

13. [REWIND] button
Rewind the song.

14. [FAST FORWARD] button
Fast forward the song.

33. [MODULATION] button
Apply a vibrato effect.

34. [PITCH BEND] wheel
Bend notes up or down.

8. [MIXER] button
Enter the Mixer menu.

9. [HARMONY] button
Turn the Harmony effect on or off.

15. [CHORD MODE] button
Enter the chord mode.

16. [BANK] button
Switch between Memories.

17. [STORE] button
Register the panel settings.

18~21. [M1] ~ [M4] buttons
Instantly call up a panel setting.

22. [O.T.S.] button
Turn the One Touch Setting function on or off. Instantly reconfigure all relevant settings.

Rear Panel

35. PHONE/ OUTPUT jack
Connect a pair of headphones or external audio equipment.

36. SUSTAIN jack
Connect a sustain pedal.

37. USB terminal
Connect to a computer to work as a USB-MIDI device.

38. DC 12V jack
Connect DC 12V power adaptor(optional).

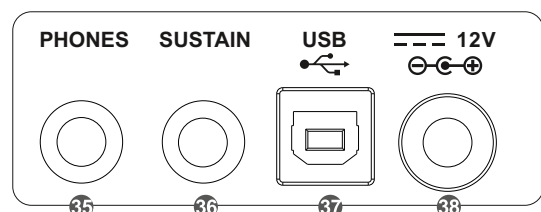

When the [SHIFT] button pressed
5~6. [ACCOMP +]~ [ACCOMP -] button
Adjust the ACCOMP volume.

7. [OCTAVE] button
Turn the Octave setting on or off.

8. [TRANPOSE] button
Turn the Transpose setting on or off.

9. [SUSTAIN] button
Turn the Sustain function on or off.

15. [FADE] button
Produce smooth Fade-ins or Fade-outs at the beginning or end of style playback.

16. [RECORD] button
Enter the Record Mode.

17. [PLAY] button
Play back recordings.

18. [DUAL] button
Turn the Dual function on or off.

19. [LOWER] button
Turn the Lower function on or off.

20. [DICT.] button
Enter the Chord Dictionary.

21. [DSP] button
Turn the DSP function on or off.

22. [TOUCH] button
Turn the Touch Response on or off.

Panel & Display Description

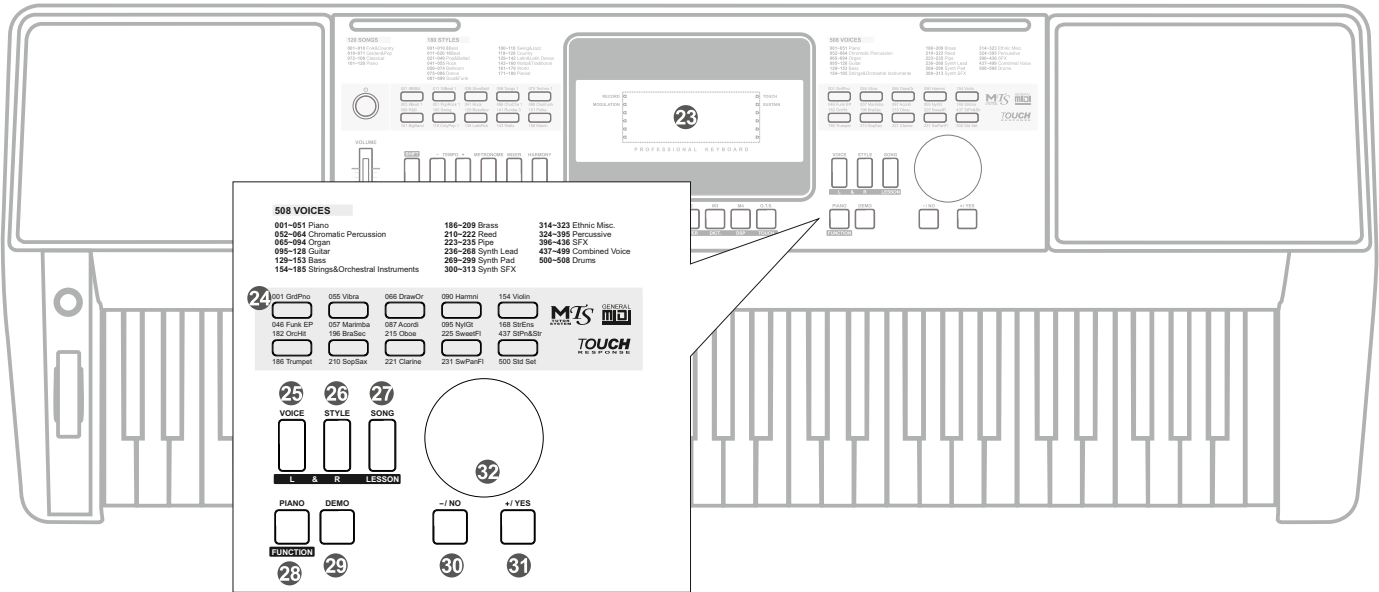

23. LCD display

Display important setting information.

24. VOICE DIRECT SELECT BUTTON

Select a direct Voice.

29. [DEMO] button

Switch to Demo Mode.

30 ~ 31. [-/NO]/ [+YES] button

Adjust parameter value.

32. DATA DIAL

Slowly or quickly adjust the parameter value.

When the [SHIFT] button Released

25. [VOICE] button

Switch to Voice Mode.

26. [STYLE] button

Switch to Style Mode.

27. [SONG] button

Enter the Song Mode.

28. [PIANO] button

Enter the Piano Mode.

When the [SHIFT] button Pressed

25. [LEFT HAND] button

Choose the Left Hand in Lesson Mode.

26. [RIGHT HAND] button

Choose the Right Hand in Lesson Mode.

27. [LESSON] button

Enter the Lesson Mode.

28. [FUNCTION] button

Enter the Function Mode.

LCD

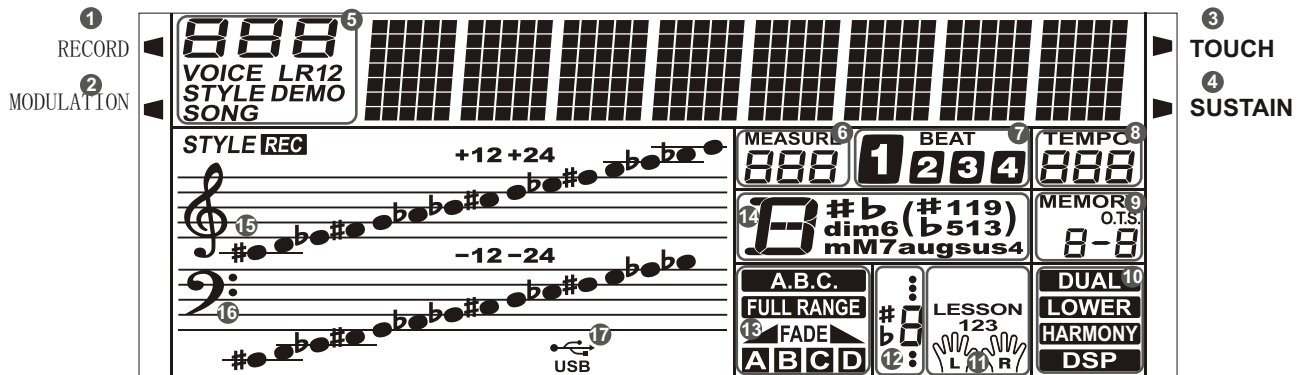

1. RECORD

2. MODULATION

3. TOUCH

4. SUSTAIN

5. VOICE/STYLE/DEMO/SONG

6. MEASURE

7. BEAT

8. TEMPO

9. M1-M4/ONE TOUCH SETTING

10. DUAL/ LOWER/ HARMONY/ DSP

11. LEFT/RIGHT HAND LESSON MODE

12. NUMBER MUSICAL NOTATION

13. A.B.C. / FULL RANGE/ FADE/A/B

14. CHORD

15. TREBLE CLEF

16. BASS CLEF

17. USB

Setup

This section contains information about setting up your instrument and preparing to play. Please go through this section carefully before turning the power on.

Power Supply

You can power the instrument either by batteries or by power adaptor. Before you switch your instrument on, turn down the volume of instrument and the connected audio equipment first.

Using Batteries

6 pieces of AA (NO.5) or equivalent alkaline batteries must first be installed into the battery compartment.

1. Open the battery compartment cover located on the bottom cabinet of the unit.
2. Insert the batteries; carefully follow the polarity markings on the cabinet.
3. Replace the compartment cover, making sure that it locks firmly in place.

Note:

1. Do not mix old and new batteries.
2. Always use same types of batteries.
3. Always remove the batteries from the unit when it is not being used for an extended period of time.

Using Power Adaptor

1. Connect the AC/DC adaptor to the power supply jack of this instrument.
2. Press the POWER SWITCH, the LCD screen is lit, which indicates the instrument has powered on.
3. If you are ready to turn off the instrument, press the POWER SWITCH again.

Note:

1. In the idle mode, the instrument will automatically shutdown in 30 minutes if you do not take any action on the instrument (Please refer to "Auto Power Off" for details).
2. When the keyboard is not in use or during thunderstorm, please disconnect the power for safety purpose.

Setting a Music Stand

A music stand is supplied with the keyboard. You can easily attach it to the instrument by inserting it into the slots at the rear of the panel.

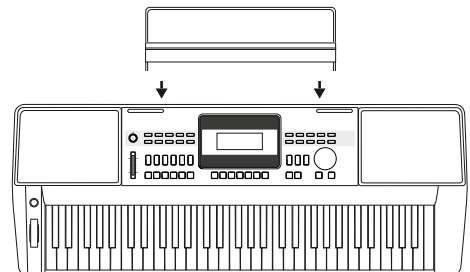
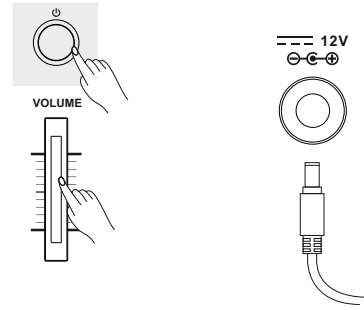
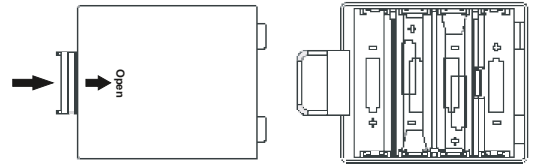

Connecting a pair of Headphones

A standard pair of stereo headphones can be connected to the PHONES jack for private practice or late-night playing. The internal stereo speaker system is automatically shut off when a pair of headphones is plugged into this jack.

Note:

To avoid the risk of hearing loss when using headphones, please do not play the piano with a high volume level for a long time.

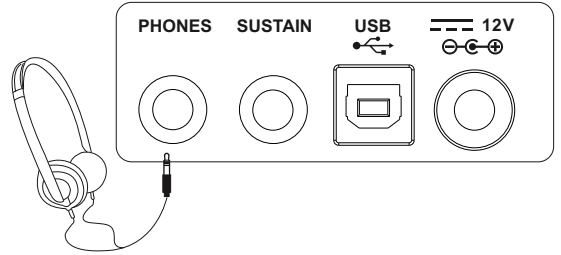

Using Sustain Pedal

Plug a function pedal into a sustain jack, you can select 4 pedal functions from the function menu setting: Sustain, Soft, switch to register memories and start/ stop a style. When using a sustain pedal in playing, your performance will remain an elegant sustain with hands out of keys, which makes the performance more expressive and abundant. (Refer to pedal function of Function Menu for details)

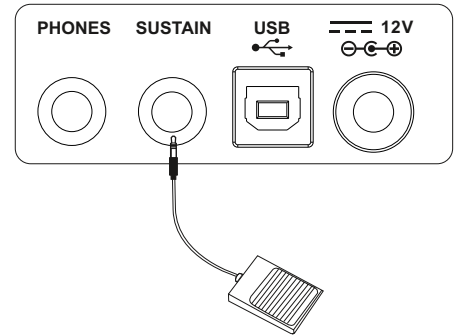

Connecting a Computer

The instrument receives and transmits MIDI messages via the USB connector.

Note:

If this product does not work correctly when connected to USB 3.0 port, you will need to connect to USB 2.0 port.

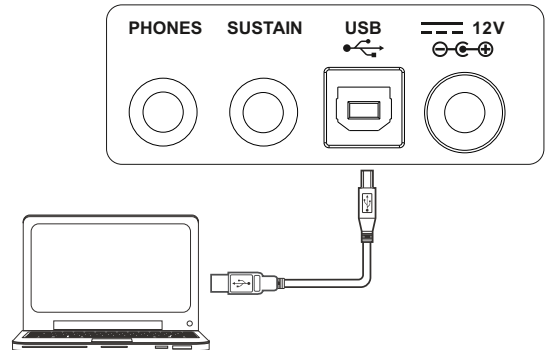

Power/Master Volume

Turn the Power On/Off

1. Firstly, please make sure you have correctly completed power connection.
2. Press POWER SWITCH, the LCD screen is lit, and displays data information on the screen, it indicates the instrument is powered on.

Note:

Press the POWER SWITCH, if the LCD screen isn't lit, please check the power is connected correctly or not.

Adjust the Master Volume

Move the MASTER VOLUME slider upwards/ downwards to increase/ decrease the volume level.

Note:

The overall volume is too low, or no sound is heard. The master volume may set too low. Set it to an appropriate level with the [MASTER VOLUME] slider. Another reason could be the headphones are connected, disabling the speak output. Try to unplug the headphones.

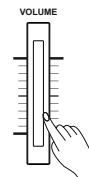

Playing Demo Songs

This instrument features 5 wonderful demos with different characters. Please refer to Demo List.

1. Press the [DEMO] button, enter the main interface of demo playing back, meanwhile, all the demo songs will loop playing.
2. Use the data dial or the [+ / Yes] / [- / No] button to select a demo song.
3. Press the [DEMO] or [START/STOP] button to stop playing, and exit demo mode.

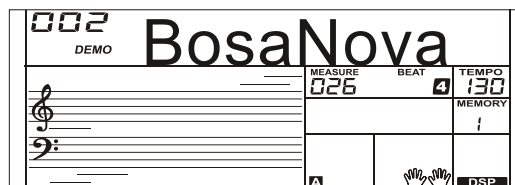
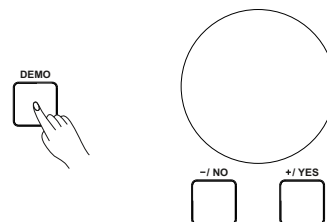

Playing Voices

1. Press the [VOICE] button.
Enter the Voice Mode. The LCD displays the current default voice name and number.
2. Select a Voice.
Use the data dial or the [+/Yes]/ [-/No] button to select the voice you want to play. You can also use the Voice Direct Button to select a voice. 2 direct voices for each button (upper & lower key).
3. Play the Voice.
You can play the keyboard and listen to the wonderful voice.

Note:

While changing a voice, pay attention to the rules. If you press the same button, the voice will be changed between the upper and lower key. When the upper/lower voice is on, and then you press another direct button, the corresponding upper/lower voice will be selected.

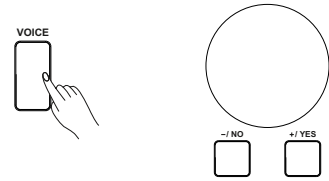

001 GrdPno	055 Vibra	066 DrawOr	090 Harmni	154 Violin
046 Funk EP	057 Marimba	087 Acordi	095 NylGt	168 StrEns
182 OrchHit	196 BraSec	215 Oboe	225 SweetFl	437 StPn&Str
186 Trumpet	210 SopSax	221 Clarine	231 SwPanFl	500 Std Set

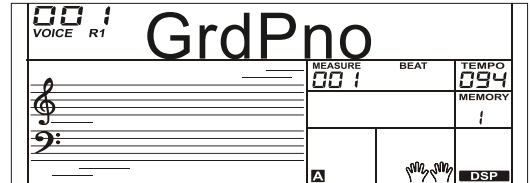

Playing Styles

1. Press the [STYLE] button.
Enter the Style Mode. The LCD displays the current default style name and number.
2. Select a Style.
Use the data dial or the [+/Yes]/ [-/No] button to select the style you want to play. You can also use the Style Direct Button to select a style. 2 direct styles for each button (upper & lower key).
3. Play the Style.
Press the [START/STOP] button, directly start a rhythm playing. Or you can press the [SYNC START] button, and press any keys to start the rhythm playing.

Note:

While changing a style, please pay attention to the rules. If you press the same button, the style will be changed between the upper and lower key. When the upper/lower style is on, and then you press another direct button, the corresponding upper/lower style will be selected.

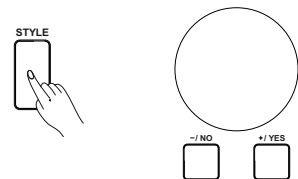

001 8BtBld	011 16Beat 1	038 SlowBald	056 Tango 1	075 Techno 1
003 8Beat 1	021 PopRock 1	041 Rock	066 ChaCha 1	088 ClasFunk
099 R&B	105 Swing	129 BosaNov	141 Rumba 3	151 Polka
101 BigBand	119 CntyPop 1	135 LatinRck	143 Waltz	156 March

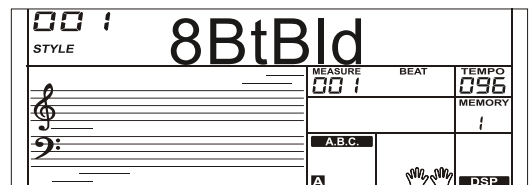

Playing Songs

This instrument has featured 120 preset songs, and each song can be practiced in LESSON mode.

1. Press the [SONG] button.
Enter the song selection mode. It will play all songs circularly.
2. Select a song.
Use the data dial or the [+ / YES] / [- / NO] button to select the song you want to play.
3. Press the [START/STOP] button.
Once you start playing a song, it will play current song repeatedly.
4. While stop playing a song, press any of [STYLE] or [VOICE] button, you can exiting the song mode.

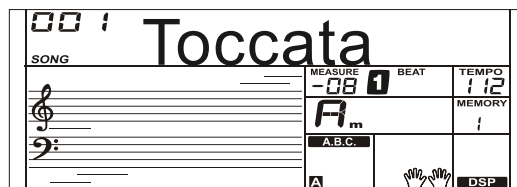
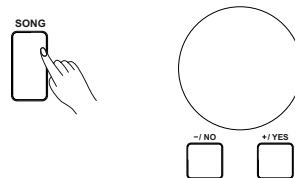

Record

You can record your performance and the accompaniment, this instrument can record up to 5 user songs.

1. Press and hold the [SHIFT] button, and then press the [RECORD] button. Enter the song mode, you can use the data dial or the [+ / YES] / [- / NO] button to select a user song to be saved.
2. Press and hold the [SHIFT] button, and then press the [RECORD] button. Enter the record standby mode, and you can select voice, style or other parameters to prepare recording.
3. Press the [START/STOP] button or play a key on the keyboard to start recording.
4. Press and hold the [SHIFT] button, and then press the [RECORD] button to exit the record mode.
5. If you want to play back a record song, you can press and hold [SHIFT] button, and then press the [PLAY] button to enter the selection interface. Use the data dial or the [+ / YES] / [- / NO] button to select the recorded song you want to play back. Press and hold the [RECORD] button and then press the [PLAY] button to play back recorded songs.
6. While playing back recorded songs, you can press and hold the [SHIFT] button and then press the [PLAY] button to exit the playing back.
7. In the selection interface of record playing back, press and hold the [SHIFT] button and then press the [RECORD] button, it displays "Delete?", press [+ / YES] to confirm delete song, or [- / NO] to cancel this operation and back to the selection interface.

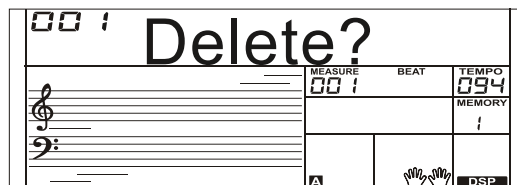
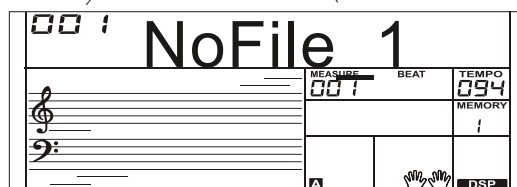

The instrument features 508 build-in voices. In order to offer you a better performance experience, we programmed many useful effects which can be inserted while playing voices. Please refer to Function Menu.

Select a Voice

The default voice number is 001 when power on and the “VOICE R1” icon will be lightening up on the left-top corner of the LCD. The current voice name and number will be display on the LCD. Use the data dial or [+ /YES] / [- /NO] button to select the voice you want to play, or you can also use the Voice Direct Button.

Note:

Press the [VOICE] button, switch to the voice mode. The “VOICE R1” icon will be lightening and display the name of upper voice. The system will judge current dual voice and lower voice are turned on or off, the sequence is:

VOICE R1 -> VOICE R2 -> VOICE L -> VOICE R1
Automatically skip the voices which haven't turned on.

Playing two voices simultaneously-DUAL

This instrument has a dual voice function. This function is capable to enhance the delicacy of your music by playing two voices of musical instruments simultaneously; new combinations of voices and music could be created then. When the dual function is off, the voice indicated is VOICE 1, when the dual function is on; the voice indicated is VOICE 2.

1. In idle mode, press and hold the [SHIFT] button and then press the [DUAL] button to turn dual function on. The LCD displays the current voice name and number, and the indicate “VOICE R 2” and “DUAL”.

You can use the data dial or [+ /YES] / [- /NO] button to select the dual voice you want to play. The default R2 voice is NO. 168: String Ensembles.

2. Play the keyboard, and then you will hear two different voices are sounded simultaneously in a layer. It seems like two different instruments playing at the same time.

3. When dual function is on, pressing and hold the [SHIFT] button and then press the [DUAL] button will turn dual function off.

Note:

When the keyboard has been split, only the right hand area will respond the dual voice, the left hand will not respond to it.

Playing Different Voices with Both hands-LOWER

The lower function splits the keyboard into right and left areas to create two different voices. The left section voice is lower voice. The A.B.C. function is on, left section keyboard can control the accompaniment; the A.B.C. function is off, left section keyboard can control the lower voice. The default split point of this instrument is: F#3 (19) and you can assign a desire split point on the keyboard. Refer to Split Point Setting for more details.

1. In idle mode, press and hold the [SHIFT] button and then press the [LOWER] button to turn the lower function on. The keyboard is split into two independent sections, and each section has its voice. The LCD displays the left hand voice name and number, and the indicate “VOICE L” and “LOWER”.

2. You can use the data dial or the [+ /YES] / [- /NO] button to select the lower voice you want to play.
The factory voice setting is NO.168: String Ensembles.

3. Play the keyboard in different sections, and you will hear two different voices.

4. When lower function is on, pressing and hold the [SHIFT] button and then press the [LOWER] button will turn lower function off.

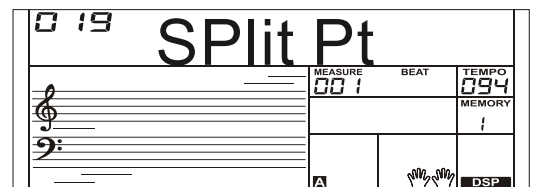
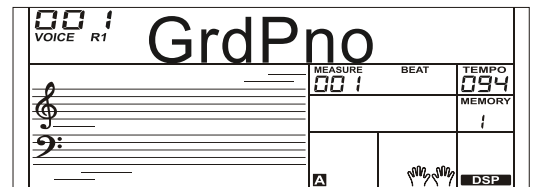
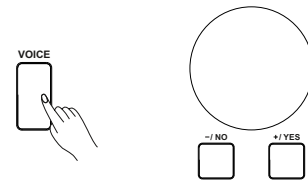

Styles

The auto accompaniment feature puts a full backing band at your fingertips. To use it, all you have to do is to play the chords with your left hand using your selected accompaniment style, and then the accompaniment will automatically play along, instantly following the chords you play. With auto accompaniment, even a solo performer can enjoy playing with the backing of an entire band or orchestra. This keyboard features 180 styles in a variety of musical genres. Try to select some of the different styles (refer to Style List) and enjoy the auto accompaniment feature.

Play Auto Accompaniment (rhythm track only)

1. Press [STYLE] button.
Enter the style mode. The "STYLE" icon on the left-top of the LCD will light up. The LCD displays the name and number of the current style.
2. Select a style.
Use the data dial or the [+ / YES] / [- / NO] button to select a style you want to play. Or you can use the Style Direct Button to make a quick selection.
3. Start playing a style.
Press the [START/STOP] button to start the rhythm tracks of the auto accompaniment. Also you can press [SYNC START] and then play any key to start the rhythm tracks of the auto accompaniment.

Play Auto Accompaniment (all tracks)

1. Turn the auto accompaniment on.
In style mode, you can press the [CHORD MODE] button to enter the "auto bass chord" (A.B.C.) mode. The keyboard is split into two sections. Left hand section is chord detect section. The "A.B.C." icon will light up. Now pressing any key in chord detect section (Sync Start status) you will hear the fantastic accompaniment. Press [CHORD MODE] button again to enter "full range" mode. The "FULL RANGE" icon will light up. The whole keyboard is chord detect section.
2. Start the auto accompaniment.
You can press [SYNC START] button and then play a chord in chord detect section to start auto accompaniment of all tracks. When you change a chord, the accompaniment automatically changes. You can also press [START/STOP] button to start auto accompaniment of rhythm track, then play a chord in chord detect section. It will start auto accompaniment of all tracks.

Accompaniment Sections

There are various types of Auto Accompaniment sections that allow you to vary the arrangement of the accompaniment to match the song you are playing. They are: Intro, Main (A, B), Fill (A, B), and Ending. By switching among them during your performance you can easily produce the dynamic elements of a professional sounding arrangement in your performance.

INTRO Section

The intro is an opening section of the song. Each preset style features two different patterns. When the intro pattern finished, the system will automatically shift to the main section.

MAIN Section

The main is an important section of the song. And it plays an accompaniment pattern and repeat infinitely until another section's button is pressed.

FILL IN Section

Auto fill in function automatically adds a fill to your performance. When the fill-in is finished, accompaniment shifts to the Main section (A,B).

ENDING Section

Ending is used for the ending of the song. When the ending is finished, accompaniment automatically stops. The length of the ending differs depending on the selected style.

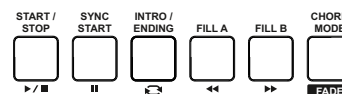
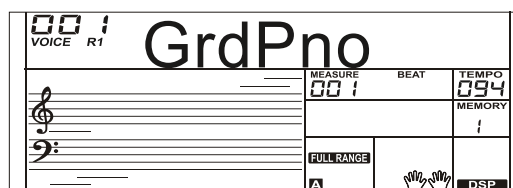
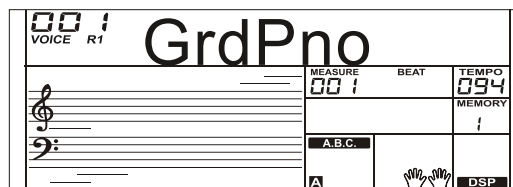
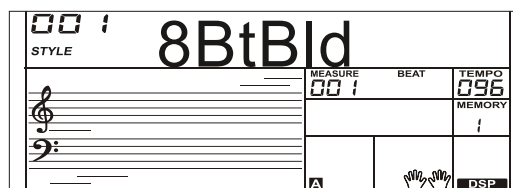
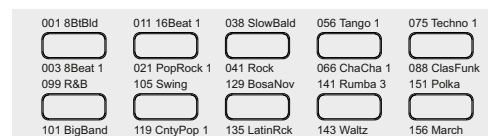
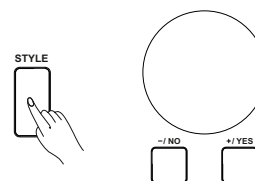

Note:

1. Hold down the [FILL A] / [FILL B] button when the style is playing, the selected fill-in pattern repeats continuously until button is released.
2. Press [FILL A] / [FILL B] button when style stops, it will change to the normal section.

Playing Different Accompaniment Sections

1. Press the [STYLE] button.
2. Press the Style Direct Button, data dial or [+ / YES] / [- / NO] button to select a style.
3. Press [CHORD MODE] button to enter A.B.C. (auto bass chord) mode.
4. Press [SYNC START] button.
5. Press the [FILL A] button, select the Main A section.
6. Press the [INTRO/ENDING] button. Now the "A" indicate on LCD, and the style is ready to play.
7. It will start the accompaniment as soon as you start playing in Chord section. When the playback of the intro is finished, it automatically leads into Main A section.
8. Press the [FILL B] button. A fill-in plays, automatically followed by the Main B section.
9. Press the [INTRO/ENDING] button again, and it will enter the Ending Section. When the ending is finished, the auto accompaniment automatically stops.

Fade

1. Fade In

Starting the style with fade in produces a smooth beginning, the volume increases from low to high.

Press and hold the [SHIFT] button and then press the [FADE] button when Style playback is stopped. The "▲FADE" icon will be lighting up, and then flashing with style playing.

2. Fade Out

Stopping the style with fade out produces a smooth ending, the volume increases from high to low. Press and hold the [SHIFT] button and then press the [FADE] button during Style playback. The "FADE ▼" icon will be lighting up, and then flashing with auto accompaniment stops.

3. Fade In/ Out Time

The default time value is 10 seconds.

Accompaniment Volume Control

Adjust the master accompaniment volume; you can use this function to balance auto accompaniment part volume and keyboard voice volume.

1. Press and hold the [SHIFT] button, and then use the [ACCOMP +] / [ACCOMP -] button to set accompaniment volume, adjustable range: 0~32, the LCD displays current accomp volume "XXX Accomp". The default value is: 24.
2. Press and hold the [SHIFT] button and then press the [ACCOMP +] / [ACCOMP -] for a while you can quickly adjust the volume value.
3. Press and hold the [SHIFT] button, at the accomp volume temporarily showed on the LCD, press the [ACCOMP +] and [ACCOMP -] buttons simultaneously to restore to its default value: 24.

Note:

The accompaniment setting will automatically exit if no operation is done over 5 seconds.

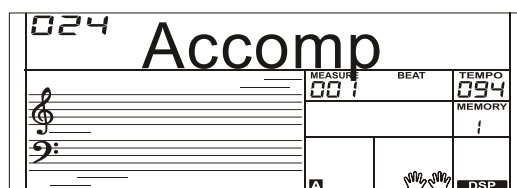
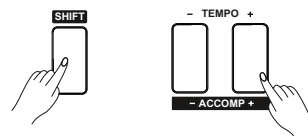
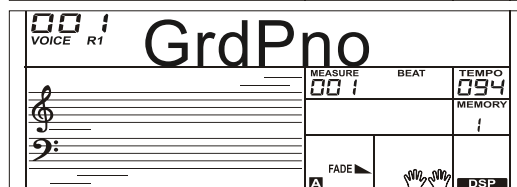
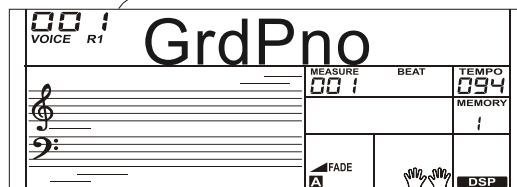
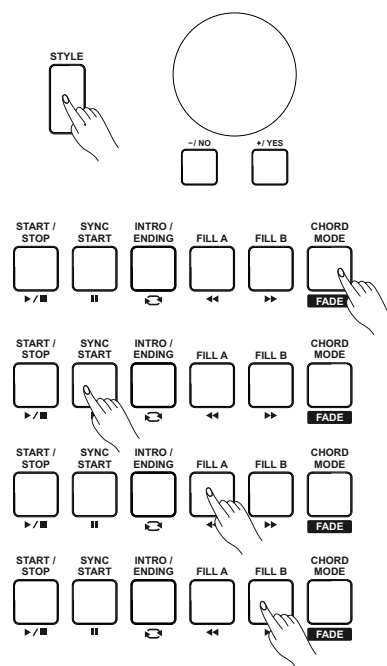

Styles

Chord Fingering

How the chords are played or indicated with your left hand (in the auto accompaniment section of the keyboard) is referred to as "fingering". There are 2 types of fingerings as described below.

Chord Basics

A chord, in music, is any harmonic set of three or more notes that is heard as if sounding simultaneously. The most frequently encountered chords are triads. A triad is a set of three notes that can be stacked in thirds. When stacked in thirds, the triad's members, from lowest pitched tone to highest, are called: the Root, the Third, and the Fifth.

Triad Type

There are following basic triad types:

Major Triad	A root with a major third added above and a perfect fifth will consist as a "Major Triad".
Minor Triad	A root with a minor third added above and a perfect fifth will consist as a "Minor Triad".
Augmented Triad	A root with a major third added above and an augmented fifth will consist as an "Augmented Triad".
Diminished Triad	A root with a minor third added above and a diminished fifth will consist as a "Diminished Triad".

Chord Inversion

We define this chord its root is not in the bass (i.e., is not the lowest note) as an inversion chord. When the root is in the bass, we call the chord: root-position chord. If we put the Third and Fifth in the root position, then it forms "Inversion", we call this chord "Inversion Chord". See the following major triad and its inverted chord.

Chord Name

The chord name contains two parts content: Chord root and Chord type.

Single Finger

Single finger type not only can detect single finger but also can detect multi finger. And the single finger makes it easily to play chords through only one, two or three keys. Including major, minor, seventh, and minor seventh chord. Refer to relevant picture on the right for details.

Multi Finger

Multi finger type only can recognize those chords have listed in the chord list, and also can be found in the dictionary function.

Note:

In full range mode, the entire keyboard will only recognize chords played in normal fingering.

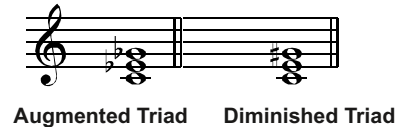
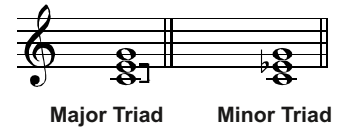
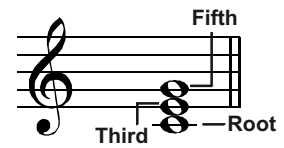

Cm

Chord Root Chord Type

	* Major Triad Only press the root note on the keyboard.
	* Minor Triad Press the root note and the nearest left black key simultaneously.
	* Seventh chord Press the root note and the nearest left white key simultaneously.

0 C	1 C ₆	2 Cm ₇	3 Cm ₇ (#11)	4 Cm(9)	5 Cm ₇ (9)
6 C ₆ (9)	7 Caug	8 Cm	9 Cm ₆	10 Cm ₇	11 Cm ₇ (b5)
12 Cm(9)	13 Cm ₇ (9)	14 Cm ₇ (11)	15 CmM ₇	16 CmM ₇ (9)	17 Cdim
18 Cdim ₇	19 C ₇	20 C ₇ sus ₄	21 C ₇ (b5)	22 C ₇ (9)	23 C ₇ (#11)
24 C ₇ (13)	25 C ₇ (b9)	26 C ₇ (b13)	27 C ₇ (#9)	28 Cm ₇ aug	29 C ₇ aug
30 C ₇ sus ₄	31 C ₁₊₂₊₅	Notes enclosed in parentheses are optional; the chords could be recognized without them.			

Tempo

Each style of the instrument has been set with a default or standard tempo; however, this can be changed by using the [TEMPO +]/[TEMPO -] button.

1. Use the [TEMPO +]/[TEMPO -] button to change the tempo. While the tempo data is flashing, use the data dial can also change the tempo.
2. Press the [TEMPO+] and [TEMPO-] buttons simultaneously to restore the default tempo setting.

Note:

The tempo will change when changing the style not playing the accompaniment. The tempo will not change when changing the style playing the accompaniment.

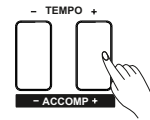

Function Menu

Press and hold the [SHIFT] button and then press the [FUNCTION] button to enter function menu. The LCD displays the default "Tune" function menu option. Use [+ / YES] / [- / NO] button to set parameter of the current menu.

The option and parameters are as follows:

No.	Content	LCD display	Range	Default
1	Tune	XXX Tune	-50 ~ +50	0
2	Split Point	XXX Split pt	1-61	19
3	Beat Type	XXX Beat	0, 2-9	4
4	Pedal Type	XXX Ped XXX	Ped Sust, Ped Soft, Ped St/S, Ped Mem	Ped Sust
5	EQ Type	XXX EQ XXX	EQ Pop, EQ Rock, EQ Class, EQ Jazz, EQ Dance, EQ Reset	EQ Reset
6	Reverb Type	XXX RevHall1	RevRoom1, RevRoom2, RevRoom3, RevHall1, RevHall2, RevHall3, RevChrh1, RevChrh2, RevDelay, RevPnDly	RevHall1
7	Reverb Level	XXX Rev Lev	0-32	23
8	Chorus Type	XXX ChrGMCr2	ChrChrs1, ChrChrs2, ChrGMCr1, ChrGMCr2, ChrFlgr1, ChrFlgr2, ChrRtry1, ChrRtry2	ChrGMCr2
9	Chorus Level	XXX Chr Lev	0-32	0
10	Harmony Types	XXX HrmDuet	HrmDuet, HrmStdTri, HrmFulCd, HrmRkDut, HrmCtDut, HrmCtTri, HrmBlock, Hrm4Cis1, Hrm4Cis2, Hrm40pen, Hrm1+5, HrmOctv1, HrmOctv2, HrmStrum	HrmDuet
11			01-16, ALL	ALL
12			01-16	01
13	MIDI Receive	XXX Midi In	30, 60, OFF	30
	MIDI Transmit	XXX Midi Out		
	Auto Power Off	XXX PowerOff		

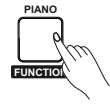

Note:

The function menu status will exit if no operation is done within 5 seconds.

Tune

This function sets the pitch of entire keyboard by steps of cents.

1. Press and hold the [SHIFT] button and then repeatedly press the [FUNCTION] button to select the tune menu. The LCD displays "xxx Tune". Use [+ / YES] / [- / NO] button or data dial to change tune value. Its range is from -50 to 50 cents.

2. Press [+ / YES] and [- / NO] buttons simultaneously will set the tune value to its default setting: 0.

3. The setting is applied to both accompaniment and the voice.

Split Point

This function sets the point which separates the entire keyboard to two sections:

1. Press and hold the [SHIFT] button and then repeatedly press the [FUNCTION] button to select split point menu. The LCD displays "xxx Split Pt". Use [+ / YES] / [- / NO] button or data dial to change Split Point. The range of Split Point is: 1-61, press the [+ / YES] and [- / NO] buttons to restore its default setting.

2. Press [+] and [-] buttons simultaneously will set the split point value to its default setting.

Note:

The Split keys belong to the left hand area.

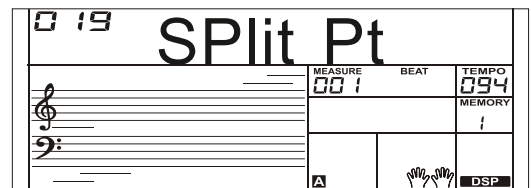
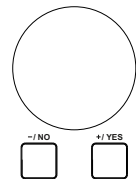
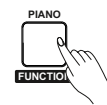
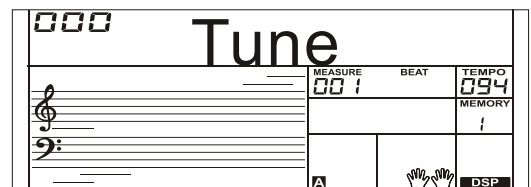
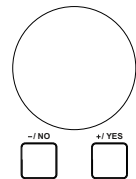
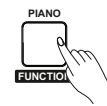

Beat Type

1. Press and hold the [SHIFT] button and then repeatedly press the [FUNCTION] button to select beat type menu. The LCD displays "xxx Beat".
Use [+ / YES] / [- / NO] button or data dial to change beat type. The range of beat type: 0, 2~9.
2. Press [+ / YES] and [- / NO] buttons simultaneously will set the beat type value to its default setting: 4.

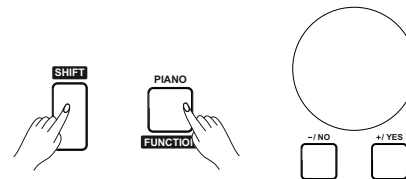
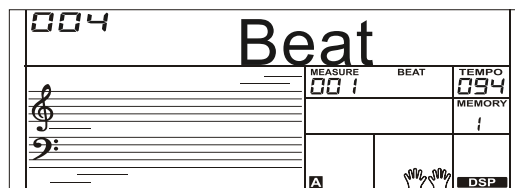
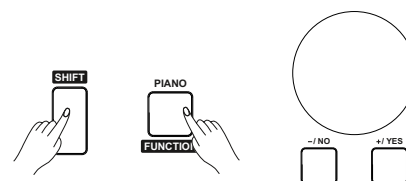

Pedal Type

1. Press and hold the [SHIFT] button and then repeatedly press the [FUNCTION] button to select pedal type menu. The LCD displays "001 Ped Sust".
Use [+ / YES] / [- / NO] button or data dial to change pedal type.
2. There are 4 types of pedal are available.
3. Press [+] and [-] buttons simultaneously will set the pedal type to its default setting: Sust.

No.	LCD Display	Pedal Function
1	Ped Sust	Sustain Pedal
2	Ped Soft	Soft Pedal
3	Ped Mem	Memory Switch Pedal
4	Ped St/S	Start/Stop Pedal

Note:

1. This instrument allows normally open and normally closed pedal, and it would be automatically detect pedal type when powered on.
2. We don't recommend you pressing the pedal while turning the instrument on, because if you do that the pedal function would be inverted.

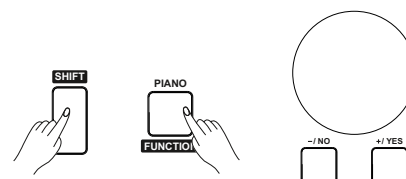
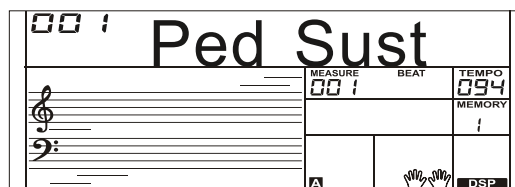
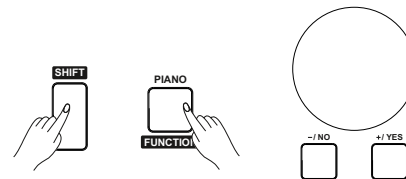

EQ Type

1. Press and hold the [SHIFT] button and then repeatedly press the [FUNCTION] button to select the EQ type menu. The LCD displays "006 EQ Reset".
Use [+ / YES] / [- / NO] button or data dial to change EQ type. There are 6 EQ types are available.

No.	LCD Display	EQ Type
1	EQ Pop	Pop
2	EQ Rock	Rock
3	EQ Class	Classical
4	EQ Jazz	Jazz
5	EQ Dance	Dance
6	EQ Reset	Reset

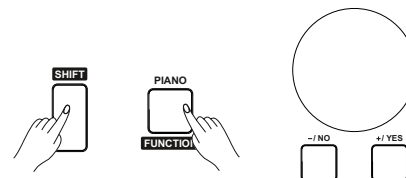
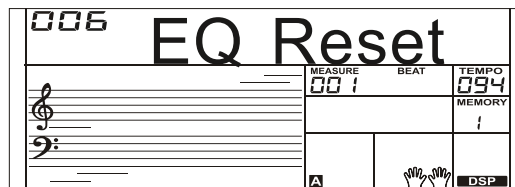

Reverb Type

- Press and hold the [SHIFT] button and then repeatedly press the [FUNCTION] button to select reverb type menu. The LCD displays "004 RevHall1".
Use [+ / YES] / [- / NO] button or data dial to change reverb type. The default setting is Hall 1.

No.	LCD Display	Reverb Type
1	RevRoom1	Room 1
2	RevRoom2	Room 2
3	RevRoom3	Room 3
4	RevHall1	Hall 1
5	RevHall2	Hall 2
6	RevHall3	Hall 3
7	RevChrh1	Church 1
8	RevChrh2	Church 2
9	RevDelay	Delay
10	RevPnDly	Pan Delay

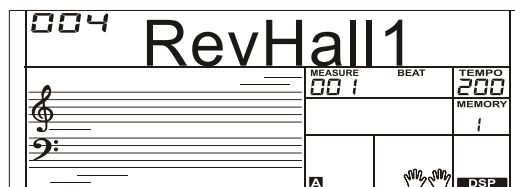

Function Menu

Reverb Level

Press and hold the [SHIFT] button and then repeatedly press the [FUNCTION] button to select reverb level. The LCD displays “xxx Rev Lev”, adjustable range is: 0-32.

Use the [+YES]/ [-NO] button or data dial to change reverb level, press the [+YES] and [-NO] buttons simultaneously to restore its default setting: 23.

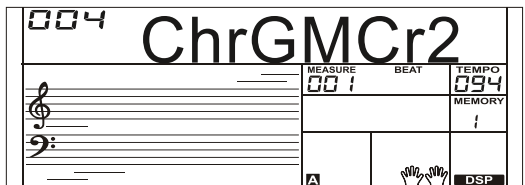
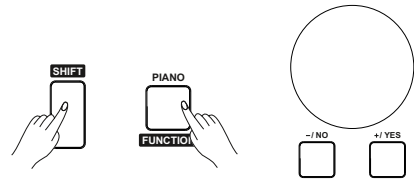
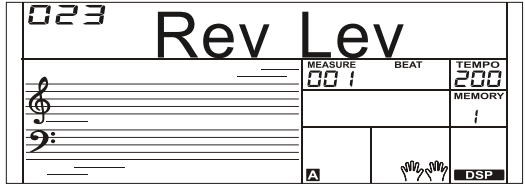
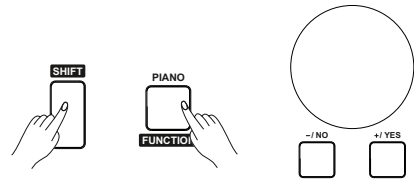

Chorus Type

Press and hold the [SHIFT] button and then repeatedly press the [FUNCTION] button to select chorus type menu. The LCD displays “004 ChrGMCr2”, Use the [+YES]/ [-NO] button or data dial to change chorus type, the default setting is GM Chorus 2.

NO.	LCD Display	Chorus Type
1	ChrChrs1	Chorus 1
2	ChrChrs2	Chorus 2
3	ChrGMCr1	GM Chorus 1
4	ChrGMCr2	GM Chorus 2
5	ChrFlgr1	Flanger 1
6	ChrFlgr2	Flanger 2
7	ChrRtry1	Rotary 1
8	ChrRtry2	Rotary 2

Chorus Level

Press and hold the [SHIFT] button and then repeatedly press the [FUNCTION] button to select chorus level menu. The LCD displays “xxx Chr Lev”, adjustable range: 0-32.

Use the [+YES]/ [-NO] button or data dial to change chorus level, Press the [+YES] and [-NO] buttons simultaneously to restore its default setting: 0.

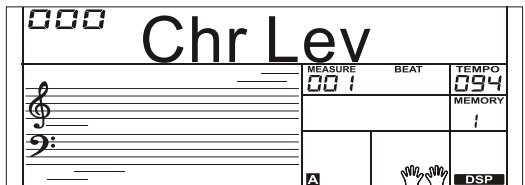

Harmony Type

Press and hold the [SHIFT] button and then repeatedly press the [FUNCTION] button to select harmony type menu. The LCD displays “001 HrmDuet”.

Use [+YES]/ [-NO] button or data dial to change harmony type. The harmony types are as follows:

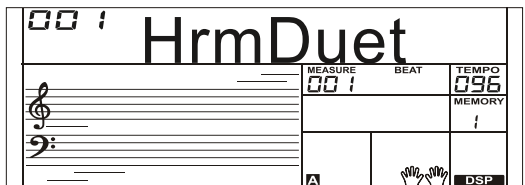
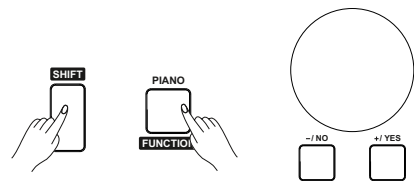

No.	LCD Display	Harmony Type
1	HrmDuet	Duet
2	HrmStdTri	StandardTrio
3	HrmFulCd	Full Chord
4	HrmRkDut	Rock Duet
5	HrmCtDut	Country Duet
6	HrmCtTri	Country Trio
7	HrmBlock	Block
8	Hrm4Cls1	4 Close 1
9	Hrm4Cls2	4 Close 2
10	Hrm4Open	4 Open
11	Hrm1+5	1+5
12	HrmOctv1	Octave 1
13	HrmOctv2	Octave 2
14	HrmStrum	Strum

Press [+YES] and [-NO] buttons simultaneously restore to its default setting: Hrm Duet.

MIDI IN/ OUT

Press and hold the [SHIFT] button and then repeatedly press the [FUNCTION] button to select MIDI in/ out menu. The LCD displays “xxx Midi In”/ “xxx Midi Out”.

1. Use [+ /YES]/ [- /NO] button or data dial to change MIDI in channel: 1~16, ALL. Press [+ /YES] and [- /NO] buttons simultaneously to restore MIDI in channel to its default setting: ALL.
2. Use [+ /YES]/ [- /NO] button or data dial to change MIDI out channel: 1~16. Press [+ /YES] and [- /NO] buttons simultaneously to restore MIDI out channel to its default setting: 1.

Auto Power Off

1. Press and hold the [SHIFT] button and then repeatedly press the [FUNCTION] button to select auto power off menu. The LCD displays “xxx Power Off”. Use [+ /YES]/ [- /NO] button or data dial to change auto power off time. This function can offer three options: 30 minutes, 60 minutes or OFF and the default setting is: 30 minutes.

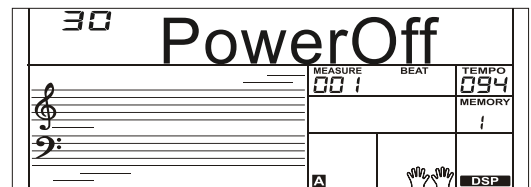
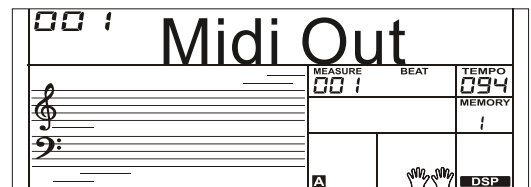
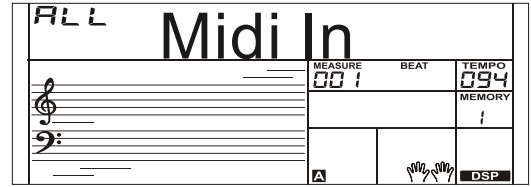
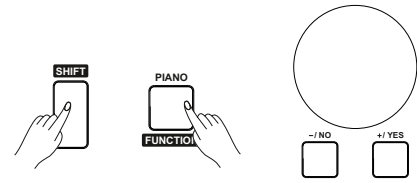

Mixer

Mixer function can control the volume of different tracks. It just likes a mini type mixing controller, separately control the left/right hand track volume, bass track volume, and rhythm track volume and so on.

1. Press the [MIXER] button to enter the mixer function menu, the LCD displays “030 Rhythm_s” for the first time when powered on; after then it will keep your last options every time.
2. Repeatedly press the [MIXER] button to select one that you want to set. Use [+ /YES]/ [- /NO] button or data dial to change parameters.

The option and parameters are as follows:

Content	LCD Display	Range	Default Value
Adjust the Rhythm track volume.	XXX Rhythm_s	0-32	30
Adjust the Percussion track volume.	XXX Rhythm_m	0-32	30
Adjust the Bass track volume.	XXX Bass	0-32	27
Adjust the Chord 1 track volume.	XXX Chord1	0-32	30
Adjust the Chord 2 track volume.	XXX Chord2	0-32	30
Adjust the Chord 3 track volume.	XXX Chord3	0-32	30
Adjust the Phrase 1 track volume.	XXX Phrase1	0-32	30
Adjust the Phrase 2 track volume.	XXX Phrase2	0-32	30
Adjust the Upper 1 track volume.	XXX Upper 1	0-32	22
Adjust the Upper 2 track volume.	XXX Upper 2	0-32	22
Adjust the Lower track volume.	XXX Lower	0-32	20

Note:

The function menu status will exit if no operation is done within 5 seconds.

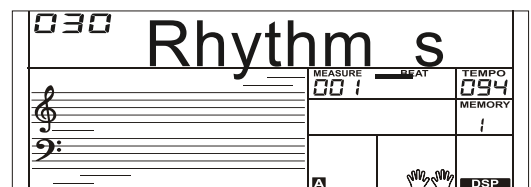
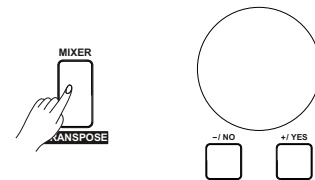

Effect Related Settings

Octave

Press and hold the [SHIFT] button and then press the [OCTAVE] button to select octave function menu. The LCD displays “xxx Octave”. Use [+ / YES] / [- / NO] button or data dial to change octave value, adjustable range is: -1 ~ +1. Press the [+ / YES] and [- / NO] buttons simultaneously to restore default setting: 0.

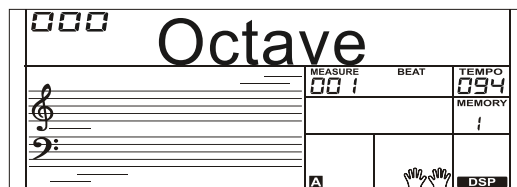
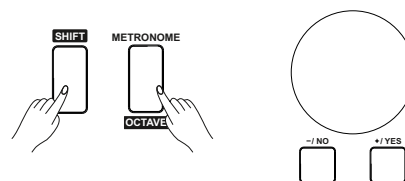

Touch

1. Press and hold the [SHIFT] button and then press the [TOUCH] button to enter touch menu. The LCD displays “xxx Touch”.
2. Use [+ / YES] / [- / NO] button or data dial to change touch response level. Default level of touch response is 2.
3. If the value is set to OFF, that means no touch response to keyboard.
4. The touch function lets you dynamically and expressively controls the level of the voice with your playing strength – just as on an acoustic instrument.

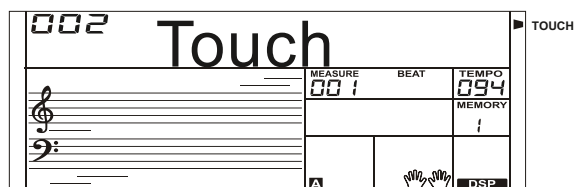
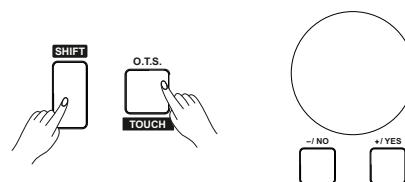

Metronome

The metronome provides a click sound, giving you an accurate tempo guide when you practice, or letting you hear and check how a specific tempo sounds.

Press [METRONOME] button to start the metronome.

To stop the metronome, press the [METRONOME] button again. (The metronome type can be set in the function menu.)

Note:

The metronome and style can be started at the same time. If you start the metronome after the style stop playing, the beat type will be changed as metronome setting; if you start the metronome while the style is playing, the beat type will be changed as style setting.

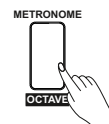

Sustain

1. Press and hold the [SHIFT] button and then press the [SUSTAIN] button to start sustain function. All notes will sustain even after releasing the keys.
2. To stop the sustain function, press and hold the [SHIFT] button and then press the [SUSTAIN] button again.

Note:

If you want a better sustain effect, you can use a sustain pedal. (Refer to pedal function for more details.)

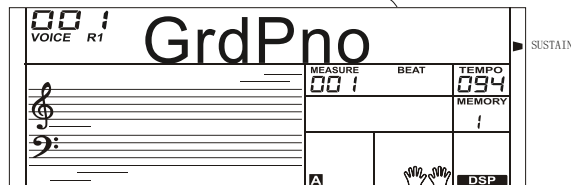
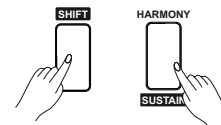

Pitch Bend

Use the pitch bend wheel to bend notes up (roll the wheel away from you) or down (roll the wheel toward you) while playing the keyboard. The pitch bend wheel is self-centering and will automatically return to normal pitch when released.

You can use the pitch bend wheel to imitate the guitar, violin, saxophone, urheen, suona and other instruments pitch bend effect, make your performance more vivid.

Modulation

The Modulation function applies a vibrato effect to notes played on the keyboard. This is applied to all the keyboard parts. Pressing the [MODULATION] button to add modulation effect and releasing [MODULATION] button to stop modulation effect.

This modulation effect is very important to those performances with urheen, guitar, and violin these string instruments, make your performance more vivid.

DSP

1. Press and hold the [SHIFT] button and then press the [DSP] button to set the DSP effect on and the icon on the LCD is lightened when keyboard is power on.
2. Stop DSP effect, press and hold the [SHIFT] button and then press the [DSP] button again to turn DSP effect off.

Note:

What is DSP?

The DSP is a simulate sounds of sound localization technology in the real environment. Since each sound should be produced in a certain space, so when you at home, in cinema or in the wilderness, even play the same violin you can hear different sounds, the difference sounds are caused by different atmosphere

Transpose

Press and hold the [SHIFT] button and then press the [TRANPOSE] button to start transpose function.

Use [+ / YES] / [- / NO] button or data dial to change transpose value, adjustable range: -12~ +12, the default value is: 0. The LCD displays "xxx Transpos".

Harmony

The harmony function can add harmony effect to the main voice. If you turn the harmony on, the harmony function will automatically add harmony notes to the notes played in the right-hand section, which gives you a rich and harmonic expression.

1. Press the [CHORD MODE] button to turn auto accompaniment on.
2. Press the [HARMONY] button to turn the harmony effect on.
3. Play a chord with your left hand.
4. Play some notes in the right-hand range of the keyboard. When a Harmony type is selected, this type automatically add one or more harmony notes to a single-note melody played in the right-hand.

Note:

1. Harmony cannot be turned on when the Full Range fingering mode is selected.
2. The harmony types of "1+5", "Octave 1" or "Octave 2" will respond whether the A.B.C. is open or not. Other types of harmony will respond only when the A.B.C. is open.

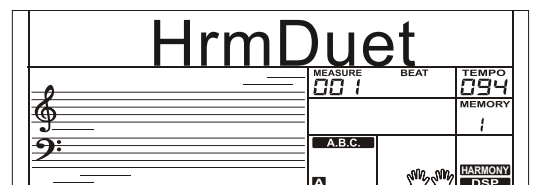
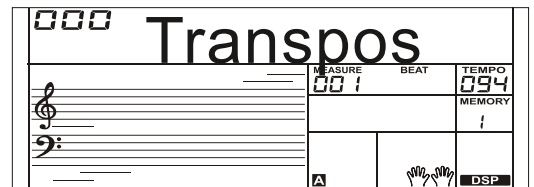
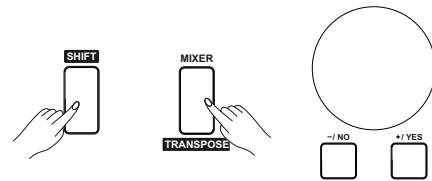
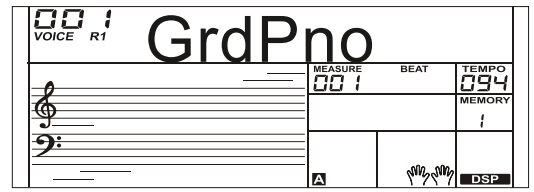
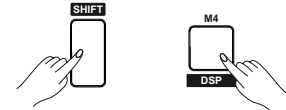
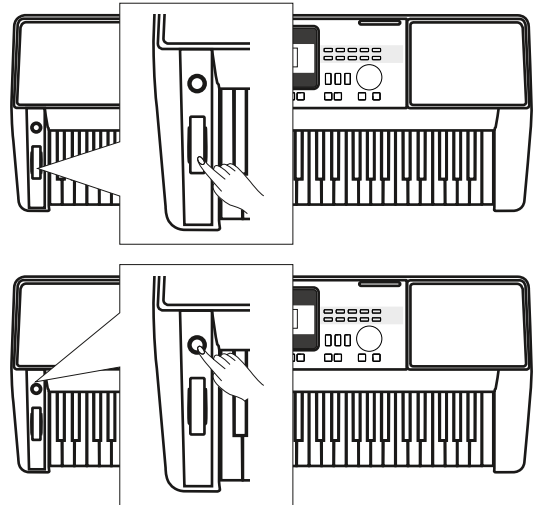

Register Memory

The Registration Memory feature can make your performance more easily and efficiently. It allows you to save virtually all panel settings to a Registration Memory setting, and you can instantly recall custom panel settings by pressing a single button.

Registration Banks

There are 8 memory banks, and each bank has 4 memories (M1-M4).

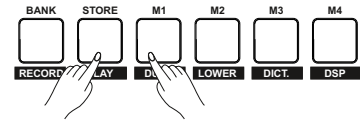

Registering the Panel Setting and Recalling the Registered Panel Settings

1. Holding down the [STORE] button press one of the registration memory buttons: [M1] - [M4]. Notice that the new settings will replace the previous memory data.
2. Press one of the registration memory buttons: [M1] - [M4]. In this example, press [M2] button, the panel settings stored in the memory 2 of bank 1 are recalled.
3. Press the [BANK] button, adjustable range 1~ 8, the LCD displays "00x Mem Bank".

Store Parameters to M1-M4

You can store the following parameters to M1-M4: Voice (including voice, dual, lower, DSP, mixer), Accompaniment (including style, tempo, and accompaniment no/off), Function Parameters (including velocity, part parameters in function menu).

Note:

1. Calling up a registered memory, change its parameters differently, the memory number which displayed on the LCD will be cleared.
2. All the memory parameters will be saved even turn the power off.

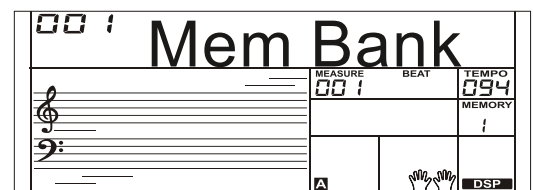
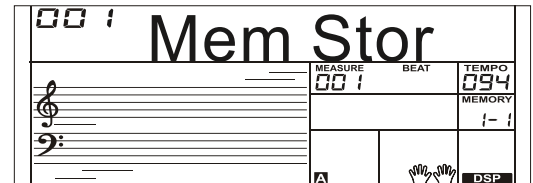

One Touch Setting

When One Touch Setting is switched on, you can instantly recall all auto accompaniment related settings including voices selection and digital effects simply with a single touch of a button.

1. Press the [O.T.S.] button to turn on the One Touch Setting for current style. The LCD displays "O.T.S.". Press one of the One Touch Setting buttons [M1]-[M4]. Various panel settings (such as voice, effect, etc.) that match the selected style can be instantly recalled with just a single button press. Auto accompaniment is automatically turned on during O.T.S mode and the lower and dual function automatically shut down.
2. If you press the [O.T.S.] button, switch to the registered memory. The LCD displays "MEMORY".
3. The configuration data of O.T.S.:
Voice (Volume, Pan, Octave)
Dual (Volume, Pan, Octave)
Left Hand (Volume, Pan, Octave)

Note:

The O.T.S. automatically turned off when you enter the song mode.

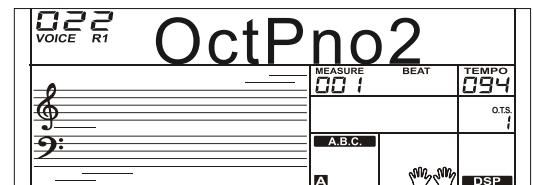
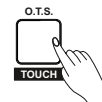

Use the powerful record function; you can record your own keyboard performance real time as a user song, just like using recording equipment, and can also playback it. Up to 5 user songs you can record in this instrument.

Prepare for Recording

1. Before you start recording, you need to select a user song to keep the recording song.
2. Press and hold the [SHIFT] button and then press the [RECORD] button to select a user song, the "REC" icon lights up. The LCD displays "XXX NoFile_X", if you have selected a user song with no record data; or the LCD displays "XXX ReSongX", if you have selected a user song with record data, for example, "001 RecSong1". You can use [+ / YES] / [- / NO] button or data dial to select a user song you want to record.
3. Press and hold the [SHIFT] button and then press the [RECORD] button, the record icon starts flashing. In the recording preparation status, you can adjust parameters such as the voice, style and so on.
4. In the recording preparation status, press and hold the [SHIFT] button and then press the [RECORD] button to exit the record mode.

Note:

The new record will cover the user song you have selected.

Start Recording

1. In the recording preparation status, press the [START/STOP] button to start recording. The LCD displays the four beat points flash in circle, and count the measures. You can start/ stop recording by pressing the [STAR/ STOP] button as you like.
2. Or you can play the keyboard to start recording. When the A.B.C. is open, play any key in left hand section would start accompaniment with chord. When the A.B.C is closed, press the [START/ STOP] button twice would start accompaniment.
3. While recoding, the [SYNC START] button is unavailable.

Stop Recording

Manually Stop Recording

Press and hold the [SHIFT] button and then press the [RECORD] button to stop recording. The "REC" icon, beat count and record icon are going out.

Automatically Stop Recoding

1. When recording is in process, if the memory is full, the recording will stop and save automatically.
2. If you choose the accomp recording, the recording will stop automatically when the ending of the rhythm finishes.

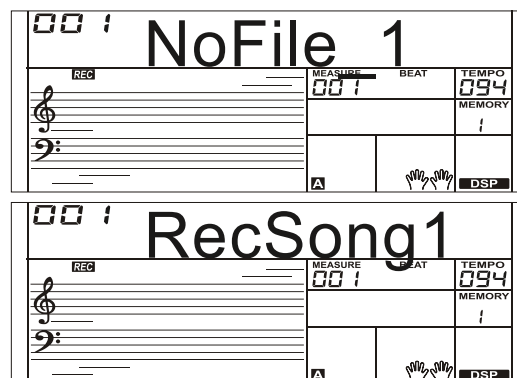

Record

Playback Recording

1. When recording is in process, holding down [SHIFT] button and then press the [PLAY] button to enter the selection interface. The LCD displays “XXX NoFile_X”, if you have selected a user song with no record data; or the LCD displays “XXX PlySongX”, if you have selected a user song with record data, for example, “001 PlySong1”. You can use [+ /YES] / [- /NO] button or data dial to select a user song you want to playback.
2. Press and hold the [SHIFT] button and then press the [PLAY] button to playback the user song.
3. If want to stop playing record, press and hold the [SHIFT] button and then press the [PLAY] button.

Delete User Song

1. Pressing and holding [RECORD] and [SONG] button together and turn power on simultaneously, all user songs will be erased.
2. In the recording playback status, holding down [SHIFT] button and then press the [RECORD] button, the LCD will display “Delete?”, press [+ /YES] button to confirm delete user song, press the [- /NO] button to cancel delete user song.

Note:

All user songs won't be erased even turn the instrument off.

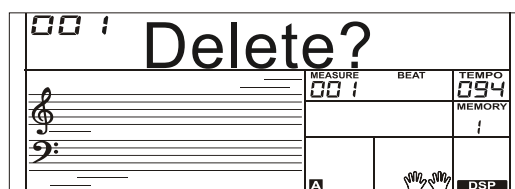
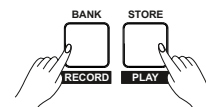
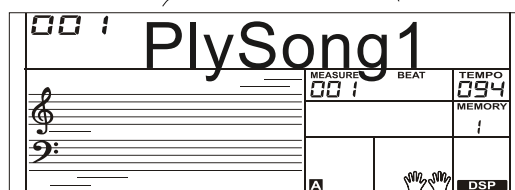

Playing the Demo Song

This instrument features 5 wonderful demos. Please refer to Demo List.

1. Press the [DEMO] button, the DEMO icon is lit, all demo songs will be played in circle.
2. Use [+ /YES] / [- /NO] button or data dial to select different demo song. Press the [DEMO] or [START/STOP] button to stop playing and exit the demo mode.

Note:

In the demo status, all buttons and keys are unavailable except [DEMO], [START/STOP], [+ /YES], [- /NO] button, [TEMPO +], [TEMPO -], data dial, [VOLUME] slider and POWER SWITCH.

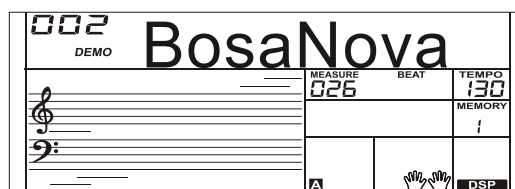
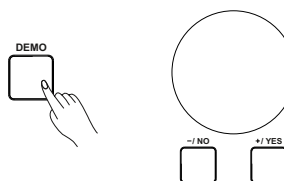

Piano Mode

This function is to set the voice of the whole keyboard to piano instantly.

1. Press the [PIANO] button can enter or exit piano mode.
2. In piano mode, the accompaniment control is the same to other mode. The accompaniment only plays the rhythm part

Note:

In piano mode, you can set the mixer function and enter function menu.

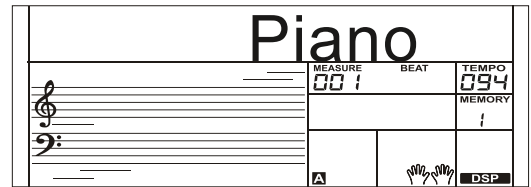
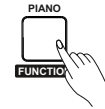

Song

The instrument has 120 songs in all, use [+ / YES] / [- / NO] button and data dial to select a song, and each song can be learned with lesson mode.

Listening to the Songs

1. Press the [SONG] button to enter the song mode. All songs will be played circularly.
2. Use the [+] or [-] button to select a song
3. When the song is stop playing:
If you press the [SONG] button, it will start all songs playing, the icon of song is lit, press the [SONG] or [START/ STOP] button to stop playing, but still in the song mode.
If you press the [START/STOP] button, it will play current song repeatedly. Start playing songs, the icon of song is lit, press the [SONG] or [START/ STOP] button to stop playing, but still in the song mode. This option is available in lesson mode.
4. When the song is stopped, press the [STYLE] or [VOICE] button will exit the song mode.

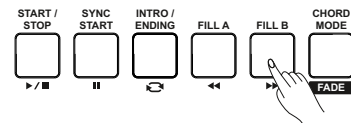
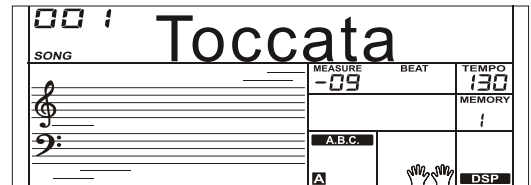

Song Control

1. Introductory Beat
Before song start playing, it has the introductory beat; the measure starts from negative value. It begins to play song when the measure goes to 1.
2. REW, FF and PAUSE
When the song is playing:
Press the [◀] button to fast forward the song.
Press the [▶] button to rewind the song (base on the measure).
Press the [⏸] button to pause the playing song, press again to continue playing.
3. Song Repeat
When playing the song, press the [↺] to set the loop begin and press it again to set the loop end. When in loop status, press [↺] again to quit the loop playing status.

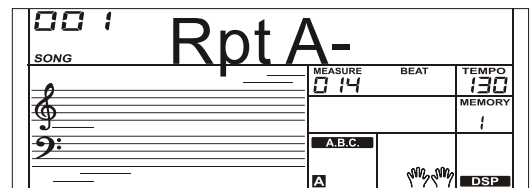
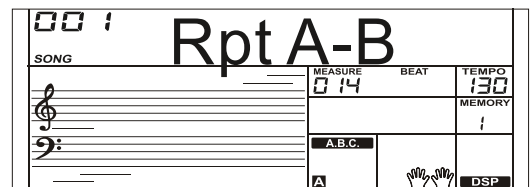

Song

Lesson Mode

This lesson mode is consisting of four combination buttons: [SHIFT] + [LESSON], [SHIFT] + [L], [SHIFT] + [R] and [SHIFT] + [L] + [R].

1. Enter the lesson mode

While the song is stop playing, holding down the [SHIFT] button and press the [LESSON] button.

2. Select the practice hand.

All songs can be learned in this mode and in three types: time training, note training and performance mode. And the keyboard has a grading system to help you to know well about your progress.

There are 3 levels of the lessons. Use [SHIFT] + [L], [SHIFT] + [R] or [SHIFT] + [L] + [R] button to select which hand you want to practice. If neither hand is selected, the keyboard will automatically select the right hand practice for you.

Note:

- According to the type of the song, the content of your practice by left hand is different. If you choose a rhythm song, the left hand practices the chord; if you choose a piano song, the left hand practices the melody. But some the MIDI song does not support this left hand lesson mode.
- You cannot change the practice mode when the song is playing. Unless you quit practicing process, or you will get a comment, which can be used to judging your learning level.
- When the song is playing, the staff and the chord will be displayed on the LCD, indicate the melody and chord position, and it will be convenient for you to practice.

Lesson 1 - Practice timing

While the song stop playing, press the combination [SHIFT] + [LESSON] buttons to enter the lesson mode. The "LESSON 1" icon is lightened on the LCD. In Lesson 1 mode, the keyboard only grade the time value of the playing, don't care the correction of the note. As long as the time value is correct, the melody will sound.

Lesson 2 - Practice note accuracy

Press the [SHIFT] + [LESSON] buttons again to enter the lesson 2 mode.

The "LESSON 2" icon lights up. In LESSON 2 mode, the keyboard only grades your practice by the note; doesn't care about the correctness of the timing. Only when you play the correct note, the song will continue to the next note.

Lesson 3 - Performance

Press the [SHIFT] + [LESSON] button in LESSON 2 to enter the lesson 3 mode. Or you can repeatedly press the [LESSON] button when the song stops playing. The "LESSON 3" icon lights up. In LESSON 3 mode, it will score your practice by the correction of the time value and note.

Comment Function:

The LESSON 1, LESSON 2 and LESSON 3 have this comment function, and it can be divide into 4 classes.

Corresponding to your playing grade, the system will play back different effect voices.

The 1 class: "Excellent!"

The 2 class: "Very Good!"

The 3 class: "Good!"

The 4 class: "Try Again!"

Automatically play back the current song after comments part, and keep up the original lesson mode.

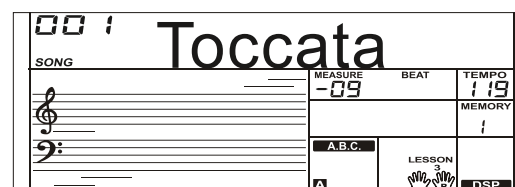
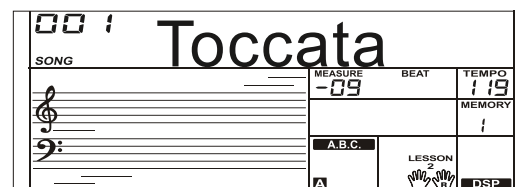
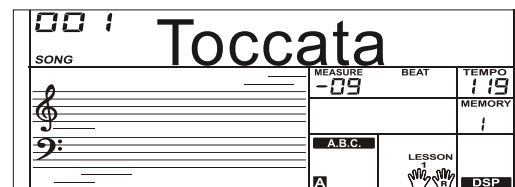
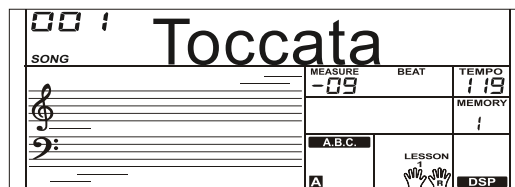
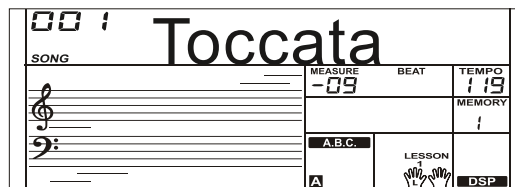

Chord Dictionary

If you know the name of a chord but don't know how to play it, you can use the Chord Dictionary function. You can learn the chord and test in this features. Displaying the chord notes on LCD and helping you clearly know the correct way to play chords.

Dict 1 (Chord Learning Mode)

- Press and hold the [SHIFT] button and then press the [DICT.] button to enter the DICT 1 mode.
The LCD display "Dict.1", and the A.B.C. automatically set to on. In DICT 1 mode, the keys C4~B5 are used to assign the Chord Type, the keys C6~B6 are used to assign the Chord Root. When the Chord Type and Chord Root are confirmed, the notes you should play for the specified chord (root and chord type) are shown in the LCD as the notation and also in the keyboard diagram.

Dict 2 (Chord Examining Mode)

In DICT 1 mode, press and hold the [SHIFT] button and then press the [DICT.] button to enter the DICT 2 mode. This is an Examining mode. The chord area on the LCD will display a random chord while the keyboard position doesn't display anything on LCD. When you play the correct chord within 3 seconds, the next chord (random) will be displayed on LCD to wait for the correct chord playing. If not, LCD will display the corresponding keyboard position automatically.

Exit Chord Dictionary

In DICT 2 mode, Press and hold the [SHIFT] button and then press the [DICT.] button again to turn off chord dictionary.

Note:

The keyboard does not sound when specified the chord root and chord type in the right hand section. Play a chord in the left hand section, a prompt sound will be heard when you play it correctly, or play back the corresponding chord to remind you.

24 Chords will be displayed in the dictionary mode as follows:

Note	Chord Root	Note	Chord Root	Note	Chord Root
C6	C	C4	M	C5	7 (b9)
C#6	C#/Db	C#4	M(9)	C#5	7 (9)
D6	D	D4	6	D5	7 (#9)
Eb6	Eb/D#	Eb4	mM7	Eb5	7 (b13)
E6	E	E4	M7	E5	7 (13)
F6	F	F4	M	F5	7 (#11)
F#6	F#/Gb	F#4	M(9)	F#5	dim7
G6	G	G4	M6	G5	dim
Ab6	Ab/G#	Ab4	M7 (9)	Ab5	7aug
A6	A	A4	M7	A5	aug
Bb6	Bb/A#	Bb4	M7b5	Bb5	7sus4
B6	B	B4	7	B5	sus4

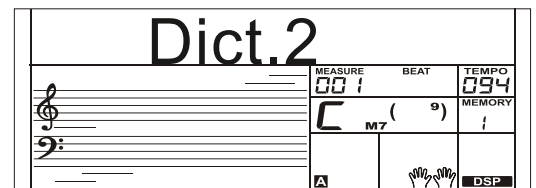
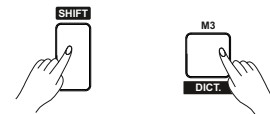
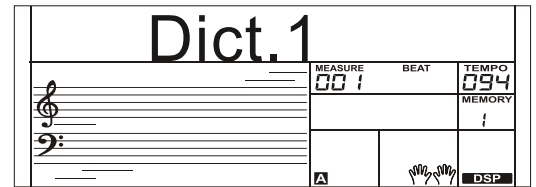
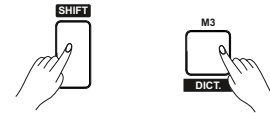

Pedal Function

Using pedal function can makes your performance more naturally and with greater expressiveness.

Multi-function Pedal

You can refer to Pedal Type chapter for details.

1. Sustain Pedal

This pedal function performs the same function as the damper pedal on an acoustic piano, letting you sustain the sound of voices even after releasing the keys.

Step and press on the pedal to turn the sustain effect on.
Release the pedal to turn the sustain effect on.

2. Soft Pedal

When the soft pedal is selected, pressing this pedal and makes them (the notes you play) sound softer.

3. Save Pedal

When the save pedal is selected, pressing this pedal at the first time to call up register memory: M1, and then you can call up register memory M2, M3...by pressing this pedal step by step (There are 32 memories).

Note:

When you pressing this pedal and change memory number, the pedal function setting of register memory will be overlapped or ignored.

4. Style Start/Stop Pedal

When the style start/stop pedal is selected, pressing this pedal to start/stop accompaniment.

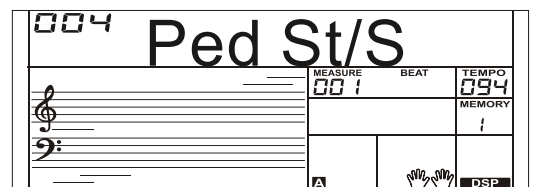
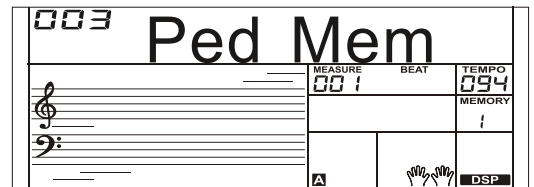
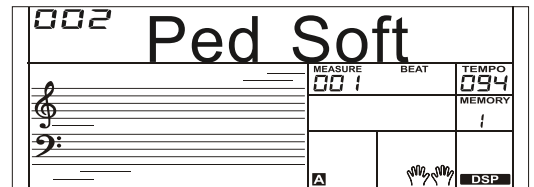
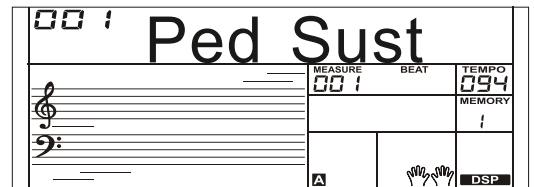
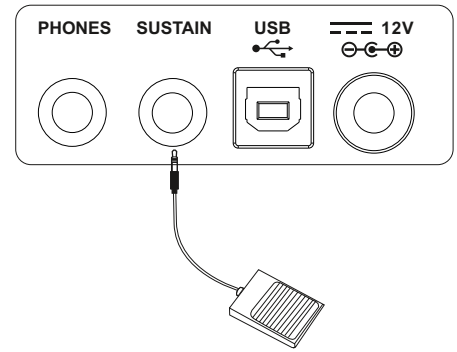

With the MIDI functions you can expand your musical possibilities. This section will let you know what MIDI is, and what it can do, as well as how you can use MIDI on your instrument.

What's MIDI?

1. MIDI (short for Musical Instrument Digital Interface) allows a wide variety of electronic musical instruments, computers and other related devices to connect and communicate with one another. MIDI carries event messages that specify notation, pitch and velocity, control signals for parameters such as volume, vibrato, audio panning, and program change information to change the voice selections.
2. The instrument can output the real-time playback information via MIDI and control external MIDI devices. The instrument can also accept incoming MIDI messages and generate sound accordingly.

Note:

This instrument has a USB(DEVICE) terminal, which can be connected to a PC as an MIDI input or MIDI output. This can not be connected with another instrument, unless other USB host device with an USB terminal.

The main application of midi

1. Used as a tone generator
This instrument can receive MIDI data from computer, and execute MIDI controls to change channels, change voices, add effect and make sound and so on. Refer to MIDI Implementation Chart for more MIDI controls.
2. Used as a MIDI Keyboard
This instrument will send MIDI data to your computer and these MIDI data are record, when you play keys, change voice and turn DSP on/off. If you play keys with accompaniment, the computer can only record your performance only. You can also edit all records, such as change channels, change voices and add DSP effects and so on, on your computer. And then you can play back them by other sound source (for example the sound card of computer). It is available to play with the instrument while playing back records. Refer to MIDI Implementation Chart for more MIDI controls.

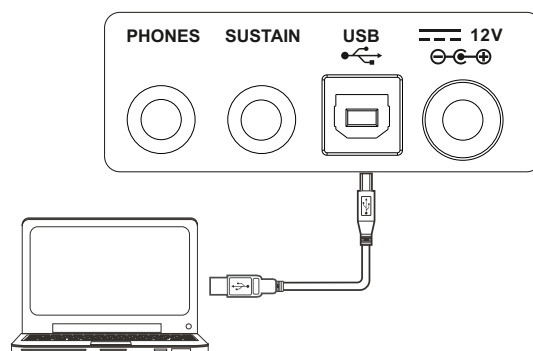

Troubleshooting

Problem	Possible Cause and Solution
The speakers produce a pop sound whenever the power is turned ON or OFF.	This is normal and is no cause for alarm.
No sound when the keyboard is played.	The R1/R2/L voice volume (Mixer) settings could be set too low. Make sure the voice volumes are set at appropriate levels.
When using a mobile phone, noise is produced.	Using a mobile phone in close proximity to the instrument may produce interference. To prevent this, turn off the mobile phone or use it further away from the instrument.
The auto accompaniment does not play back even Sync is in standby condition and a key is pressed.	You may be trying to start accompaniment by playing a key in the right-hand range of the keyboard. To start the accompaniment with Sync Start, make sure to play a key in the left-hand range of the keyboard.
Certain notes sound at wrong pitch.	Make sure that the tuning value is set to 0. Press and hold the [+ / YES] and [- / NO] buttons at the same time, then turning the power on will set INSTRUMENT to default.
The Harmony function does not operate.	And Harmony cannot be turned on when a drum kit is selected for the voice R1.

Notice:

If you notice any abnormality cannot handle, please connect the provider or specified repair station, and have the instrument inspected by qualified service personnel.

Specifications

Keys

61 Keys with Touch Keyboard, 3 Touch Levels

LCD Display

Multi-functional LCD

Polyphony

128

Voices

508

Styles

180

Demos

5

Songs

120

Tempo

30-280

Panel Memory

32

DSP

Use this feature you will hear a broader and fuller play effect

Chord mode

Single-finger, Multi-finger

Chord dictionary

Convenient for users to learn chords

Accompany [song] control button

Start/Stop, Sync Start, Intro/Ending, Fill A, Fill B, Chord mode(Fade).

Record

5 user song, support playback

Control button

Power Switch, Volume Slider, Style Direct Button, Shift, Tempo+/- (Accomp+/-), Metronome(Octave), Mixer(Transpose), Harmony(Sustain), Start/Stop, Sync Start, Intro/Ending, Fill A, Fill B, A.B.C.(Fade), Bank(Record), Store(Play), M1(Dual), M2(Lower), M3(Dict.), M4(DSP), O.T.S.(Touch), Voice Direct Button, Voice(L), Style(R), Song(Lesson), Piano(Function), Demo, -/NO, +/YES, Data Dial

Connectors

USB IN, Multi-function Pedal, Headphones/Output

Power Supply

DC 12V IN

Speaker

4ohm 10W x 2

Dimensions

970 x 370 x 142 mm

Weight

6 kg

* All specifications and appearances are subject to change without notice.

Voice List

NO.	Name	LCD Name
Piano		
1	Acoustic Grand Piano	GrdPno
2	Acoustic Grand Piano 2	GrdPno 2
3	Acoustic Grand Piano (wide)	GrdPnoW
4	Acoustic Grand Piano (dark)	GrdPnoD
5	Bright Acoustic Piano	BritePn
6	Bright Acoustic Piano 2	BritePn2
7	Bright Acoustic Piano (wide)	BritePnW
8	Electric Grand Piano	E.Piano
9	Electric Grand Piano 2	E.Piano2
10	Electric Grand Piano (wide)	E.GdPnoW
11	Electric Grand Piano (dark)	E.GdPnoD
12	Honky Tonk Piano	HnyTonk
13	Honky Tonk Piano 2	HnyTonk2
14	Honky Tonk Piano (wide)	HnyTonkW
15	Honky Tonk Piano (dark)	HnyTonkD
16	Harpsichord	Harpsi
17	Harpsichord 2	Harpsi 2
18	Harpsichord (octave mix)	HarpsiO
19	Harpsichord (wide)	HarpsiW
20	Harpsichord (with key off)	HarpsiK
21	Octave Grand Piano	OctPno
22	Octave Grand Piano 2	OctPno 2
23	Piano & Strings	Pno&Str
24	Piano & Pad	Pno&Pad
25	Piano & Choir	Pno&Cho
26	Piano & EP	Piano&EP
27	Piano & Vibraphone	Pno&Vib
28	Detuned Electric Piano	DetEP
29	Detuned Electric Piano 2	DetEP 2
30	Electric Piano	E.Pno
31	Electric Piano 2	E.Pno 2
32	Electric Piano 3	E.Pno 3
33	Electric Piano 4	E.Pno 4
34	Electric Piano 1 (velocity mix)	VelEP 1
35	Electric Piano 2 (velocity mix)	VelEP 2
36	60's Electric Piano	60's EP
37	EP Legend	E.Legend
38	Phase EP	Phase EP
39	Clavi	Clavi
40	Clavi 2	Clavi 2
41	Phase Clavi	PhaClavi
42	Wah Clavi	WahClavi
43	Pulse Clavi	PulClavi
44	Dream EP	DreamEP
45	Tremolo EP	TremEP
46	Funk EP	Funk EP
47	Warm EP	Warm EP
48	Choir EP	Choir EP
49	Wah EP	Wah EP
50	Modern EP	ModernEP
51	EP Pad	EPPad
Chromatic Percussion		
52	Celesta	Celesta
53	Glockenspiel I	GlckcspI

54	Music Box	Mbox
55	Vibraphone	Vibra
56	Vibraphone (wide)	VibraW
57	Marimba	Marimba
58	Marimba (wide)	MarimbaW
59	Xylophone	Xyloph
60	Tubular Bells	TubulBe
61	Church Bell	ChurBell
62	Carillon	Carillon
63	Dulcimer	Dulcime
64	Santur	Santur
Organ		
65	Italian 60's Organ	60'sOr
66	Drawbar Organ	DrawOr
67	Drawbar Organ 2	DrawOr 2
68	Detuned Drawbar Organ	DetDrOr
69	Drawbar Organ 3	DrawOr 3
70	Detuned Percussive Organ	DetPerOr
71	Percussive Organ	PercOr
72	Percussive Organ 2	PercOr 2
73	70's Percussive Organ	70'sPeOr
74	Percussive Organ 3	PercOr 3
75	Rock Organ	RockOr
76	Rock Organ 2	RockOr 2
77	Rock Organ 3	RockOr 3
78	Church Organ	ChurOr
79	Church Organ 2	ChurOr 2
80	Church Organ 3	ChurOr 3
81	Church Organ (octave mix)	ChurOrO
82	Detuned Church Organ	DetChuOr
83	Reed Organ	ReedOr
84	Reed Organ 2	ReedOr 2
85	Rotary Organ	RotaryOr
86	Puff Organ	PuffOr
87	Accordion	Acordi
88	Accordion 2	Acordi 2
89	Accordion 3	Acordi 3
90	Harmonica	Harmni
91	Harmonica 2	Harmni 2
92	Harmonica 3	Harmni 3
93	Tango Accordion	TangoAc
94	Tango Accordion 2	TangoAc2
Guitar		
95	Acoustic Guitar (nylon)	NylGt
96	Acoustic Guitar (nylon) 2	NylGt 2
97	Acoustic Guitar (nylon) 3	NylGt 3
98	Acoustic Guitar (nylon + key off)	NylGtK
99	Ukulele	Ukulele
100	Acoustic Guitar (steel)	Ac.Gt
101	Acoustic Guitar (steel) 2	Ac.Gt 2
102	12-Strings Guitar	12StrGt
103	Mandolin	Mandol
104	Mandolin 2	Mandol 2
105	Steel Guitar with Body Sound	SteGtBod
106	Electric Guitar (jazz)	JazzGt
107	Electric Guitar (jazz) 2	JazzGt 2

Voice List

108	Electric Guitar (pedal steel)	PedalGt
109	Electric Guitar (clean)	CleaGt
110	Electric Guitar (clean) 2	CleaGt 2
111	Electric Guitar (detuned clean)	DetClGt
112	Mid Tone Guitar	MidGt
113	Electric Guitar (muted)	MuteGt
114	Electric Guitar (muted) 2	MuteGt 2
116	Electric Guitar (funky cutting)	FunkGt
117	Electric Guitar (muted velo-sw)	VelMutGt
118	Jazz Man	JazzMan
119	Overdriven Guitar	OverGt
120	Overdriven Guitar 2	OverGt 2
121	Guitar Pinch	GtPinch
122	Distortion Guitar	DistGt
123	Distortion Guitar 2	DistGt 2
125	Distortion Guitar (with feedback)	DistFeGt
126	Guitar Feedback	FeedbGt
127	Distorted Rhythm Guitar	DistRhGt
128	Guitar Harmonics	GtHarmo
129	Guitar Harmonics 2	GtHarmo2
129	Velocity Nylon Guitar	VelNylGt
130	Bass	
132	Acoustic Bass	A.Bass
133	Acoustic Bass 2	A.Bass 2
134	Wah Bass	WahBass
135	Electric Bass (finger)	FingerBa
136	Finger Slap Bass	FinrSlBa
137	Electric Bass (pick)	PickBa
138	Electric Bass (pick) 2	PickBa 2
139	Fretless Bass	FretBa
140	Fretless Bass 2	FretBa 2
142	Slap Bass	SlapBa
143	Slap Bass 2	SlapBa 2
144	Slap Bass 3	SlapBa 3
145	Slap Bass 4	SlapBa 4
146	Synth Bass	SynBa
147	Synth Bass 2	SynBa 2
148	Synth Bass 3	SynBa 3
149	Synth Bass 4	SynBa 4
150	Warm Synth Bass	WarSynBa
152	Rsonance SynBass	ResSynBa
153	Clavi Bass	ClaviBa
	Hammer	Hammer
154	Attack Bass	AttackBa
155	Synth Bass (rubber)	RubBa
156	Synth Bass (rubber) 2	RubBa 2
157	Attack Pulse	AttPulse
158	Strings & Orchestral Instruments	
160	Violin	Violin
161	Violin 2	Violin 2
	Violin (slow attack)	SlowVin
	Viola	Viola
	Viola 2	Viola 2
	Cello	Cello
	Cello 2	Cello 2
	Contrabass	ConBa

162	Tremolo Strings	TreStr
163	Tremolo Strings 2	TreStr 2
164	Pizzicato Strings	PizStr
165	Orchestral Harp	Harp
166	Yang Chin	YangChin
167	Timpani	Timpani
168	String Ensembles	StrEns
169	String Ensembles 2	StrEns 2
170	String Ensembles 3	StrEns 3
171	String Ensembles 3	StrEns 3
172	Strings & Brass	Str&Brs
173	60's Strings	60's Str
174	Synth Strings	SynStr
175	Synth Strings 2	SynStr 2
176	Synth Strings 3	SynStr 3
177	Choir Aahs 2	ChoAah
178	Choir Aahs	ChoAah 2
179	Choir Aahs	ChoAah 2
180	Voice Oohs	VoiOhs
181	Humming	Humming
182	Anlong Voice	AnlVoice
183	Synth Voice	SynVo
184	Orchestra Hit	OrcHit
185	Bass Hit Plus	BaHit
186	6th Hit	6th Hit
187	Euro Hit	Euro Hit
	Brass	
189	Trumpet	Trumpet
190	Dark Trumpet	DarkTp
191	Trombone	Tromb
192	Trombone 2	Tromb 2
193	Bright Trombone	BritBone
194	Tuba	Tuba
195	Muted Trumpet	MutTp
196	Muted Trumpet 2	MutTp 2
197	Muted Trumpet 2	MutTp 2
198	French Horn	FrHorn
199	French Horn 2	FrHorn 2
200	Brass Section	BraSec
201	Brass Section 2	BraSec 2
202	Synth Brass	SynBra
203	Synth Brass 2	SynBra 2
204	Synth Brass 3	SynBra 3
205	Synth Brass 4	SynBra 4
206	Synth Brass 5	SynBra 5
207	Synth Brass 5	SynBra 5
208	Analog Synth Brass	AnSyBra
209	Analog Synth Brass 2	AnSyBra2
210	Analog Synth Brass 3	AnSyBra3
211	Jump Brass	JumBra
212	Jump Brass 2	JumBra 2
213	Funny	Funny
214	Funny 2	Funny 2
	Reed	
	Soprano Sax	SopSax
	Soprano Sax 2	SopSax 2
	Alto Sax	AltSax
	Tenor Sax	TenoSax
	Baritone Sax	BariSax

215	Oboe	Oboe
216	2 Oboe	2 Oboe
217	English Horn	EngHorn
218	2 English Horn	2EngHorn
219	Bassoon	Bassoon
220	2 Bassoon	2Bassoon
221	Clarinet	Clarine
222	2 Clarinet	2Clarine
Pipe		
224	Piccolo	Piccolo
225	2 Piccolo	2Piccolo
226	Sweet Flute	SweetFl
227	Flute	Flute
228	2 Flute	2 Flute
229	Recorder	Recorde
230	2 Recorder	2Recorde
231	Pan Flute	PanFl
232	Sweet Pan Flute	SwPanFl
233	Blown Bottle	BloBott
234	Shakuhachi	Shakuh
235	Whistle	Whistle
	Ocarina	Ocarina
Synth Lead		
237	Lead 1 (square)	Squ Ld
238	Lead 1a (square)2	Squ Ld 2
239	Lead 1b (sine)	Sine Ld
240	Lead 2 (sawtooth)	Saw
241	Lead 2a (sawtooth) 2	Saw 2
242	Lead 2b (saw + pulse)	Saw&Puls
243	Lead 2c (double sawtooth)	DoubSaw
244	Lead 2d (sequenced analog)	SeqAna
245	Wavy Sawtooth	WavySaw
246	Super Analog	SuperAna
247	Lead 3 (calliope)	Callio
248	Lead 4 (chiff)	ChiffLd
249	Lead 5 (charang)	CharaLd
250	Lead 5a (wire lead)	Wire Ld
251	Lead 6 (voice)	VoiceLd
252	Lead 7 (fifths)	Fifths
253	Lead 8 (bass + lead)	Bass&Ld
254	Lead 8a (soft wrl)	Soft wrl
255	Massiness	Massin
256	Square	Square
257	Slow Square Lead	SlSquLd
258	Sine Solo	SineSolo
259	Thick Square	ThickSqu
260	2Oscillators Lead	2OscLd
261	Wavy Sawtooth	WavySaw
262	Super Analog	SuperAna
263	Big Lead	Big Ld
264	Fat Lead	Fat Ld
265	PWM 4th	PWM 4th
266	Delayed Lead	DelLd
267	Fifth Lead	Fifth Ld
	Corrie	Corrie

268	Quint	Quint
Synth Pad		
269	Pad 1 (new age)	NewAge
270	Pad 2 (warm)	WarmPd
271	Pad 2a (sine pad)	Sine Pad
272	Pad 3 (polysynth)	PolySyn
273	Pad 4 (choir)	ChoirPd
274	Pad 4a (itopia)	ItopiaPd
275	Pad 5 (bowed)	BowedPd
276	Pad 6 (metallic)	MetaPd
277	Pad 7 (halo)	HaloPad
278	Pad 8 (sweep)	SweepPd
279	Pad 8 (sweep) 2	SweepPd2
280	Pad 8 (sweep) 3	SweepPd3
281	Pan Pad	PanPad
282	Pan Pad 2	PanPad 2
283	Dipolar Pad	DipolPad
284	PWM Pad	PWM Pad
285	Warmly Pad	WarmPad
286	Horn Pad	Horn Pad
287	Click Pad	ClickPad
288	Analog Pad	Ana Pad
289	80's Poly Pad	80'sPoly
290	PWM 4th Soft	PWM4thSf
291	Synth Calliope Soft	SynCalSf
292	Soft Vox	Soft Vox
293	5th SawWave	5th Saw
294	5th Lead Soft	5thLdSf
295	Slow Square	Slow Squ
296	New Year Pad	NewYearP
297	Space Voice	SpaVoice
298	Rising	Rising
299	Congregate	Congrega
Synth SFX		
300	FX 1 (rain)	Rain
301	FX 2 (soundtrack)	SoundTk
302	Prelude	Prelude
303	FX 3 (crystal)	Crystal
304	FX 3a (synth mallet)	SynMalle
305	FX 4 (atmosphere)	Atmosp
306	Warm Air	Warm Air
307	FX 5 (brightness)	Bright
308	Smog	Smog
309	FX 6 (goblins)	Goblins
310	FX 7 (echoes)	Echoes
311	FX 7b (echo pan)	Echo Pan
312	FX 7a (echo bell)	EchoBell
313	FX 8 (sci-fi)	Sci-Fi
314	Sitar	Sitar
315	Sitar 2	Sitar 2
316	Banjo	Banjo
317	Shamisen	Shamis
318	Koto	Koto
319	Taisho Koto	TaisKoto
320	Kalimba	Kalimba

Voice List

321	Bag Pipe	BagPipe
322	Fiddle	Fiddle
323	Shanai	Shanai
Percussive		
324	Tinkle Bell	TinkBe
325	Agogo	Agogo
326	Steel Drums	SteeDru
327	Woodblock	WoodBlo
328	Castanets	Castan
329	Taiko Drum	TaiDrum
330	ConcertBass Drum	ConBsDr
331	Acoustic Bass Drum	ABaDrum
332	Room Kick	RoomKick
333	Power Kick	PoweKick
334	Electric Bass Drum	EiBaDrum
335	Analog Bass Drum	AnBaDrum
336	Jazz Kick	JazzKick
337	Side Stick	SidStick
338	Analog Rim Shot	AnRiShot
339	Acoustic Snare	A.Snare
340	Room Snare	RoomSn
341	Power Snare	PowerSn
342	Electric Snare	E.Snare
343	Analog Snare	Ana Sn
344	Jazz Snare	JazzSn
345	Brush Tap	BrushTap
346	Concert SD	ConSD
347	Hand Clap	HandClap
348	Tom	Tom
349	Room Tom	Room Tom
350	Power Tom	PowerTom
351	Electric Tom	E.Tom
352	Analog Tom	Ana Tom
353	Brush Tom	BrushTom
354	Closed Hi-hat	ClosedHH
355	Analog Closed Hi-hat	AnClosHH
356	Pedal Hi-hat	Pedal HH
357	Open Hi-hat	Open HH
358	Crash Cymbal	CrashCym
359	Analog Cymbal	Ana Cym
360	Ride Cymbal	Ride Cym
361	China Cymbal	ChinaCym
362	Ride Bell	RideBell
363	Tambourine	Tambouri
364	Splash Cymbal	SplashCy
365	Cowbell	Cowbell
366	Analog Cowbell	AnaCowbl
367	High Bongo	HiBongo
368	Low Bongo	LoBongo
369	Mute Hi Conga	MuHiCong
370	Open Hi Conga	OpHiCong
371	Low Conga	LoConga
372	Analog Hi Conga	AnHiCong
373	Analog Mid Conga	AnMiCong
374	Analog Low Conga	AnLoCong

375	High Timbale	HiTimbal
376	Low Timbale	LoTimba
377	Cabasa	Cabasa
378	Maracas	Maracas
379	Analog Maracas	AnMarac
380	Short Guiro	ShGuiro
381	Long Guiro	LoGuiro
382	Claves	Claves
383	Mute Cuica	MuCuica
384	Open Cuica	OpCuica
385	Mute Triangle	MuTrge
386	Open Triangle	OpTrge
387	Shaker	Shaker
388	Mute Surdo	MuSurdo
389	Open Surdo	OpSurdo
390	Melodic Tom	MeloTom
391	Melodic Tom 2	MeloTom2
392	Synth Drum	SynDrum
393	Rhythm Box Tom	RhTom
394	Electric Drum	E.Drum
395	Reverse Cymbal	ReveCym
SFX		
396	Guitar Fret Noise	GtFreNo
397	Guitar Cutting Noise	GtCutNo
398	Acoustic Bass String Slap	BsStrSl
399	Breath Noise	BreNois
400	Flute Key Click	FiClick
401	Seashore	Seashor
402	Rain	Rain
403	Thunder	Thunder
404	Wind	Wind
405	Stream	Stream
406	Bubble	Bubble
407	Bird Tweet	BirdTw
408	Bird Tweet 2	BirdTw 2
409	Dog	Dog
410	Horse Gallop	HorseGal
411	Telephone Ring	TelRing
412	Telephone Ring 2	TelRing2
413	Door Creaking	DoorCrea
414	Door	Door
415	Scratch	Scratch
416	Wind Chime	WindChim
417	Helicopter	Helicopt
418	Car Engine	CarEngin
419	Car Stop	Car Stop
420	Car Pass	Car Pass
421	Car Crash	CarCrash
422	Siren	Siren
423	Train	Train
424	Jetplane	Jetplane
425	Starship	Starship
426	Burst Noise	BurstNoi
427	Applause	Applause
428	Laughing	Laughing

429	Screaming	Scream
430	Punch	Punch
431	Heart Beat	HeartBea
432	Footsteps	Footstep
433	Gunshot	Gunshot
434	Machine Gun	MachiGun
435	Lasergun	Lasergun
436	Explosion	Explosio
Combined Voice		
437	Stereo Piano & Strings Pad	StPn&Str
438	Stereo Piano & Choir	StPn&Cho
439	Stereo Piano & Synth Strings	StPn&Syn
440	Stereo Piano & Warm Pad	StPn&Pad
441	Stereo Piano & Soft Ep	StPn&Ep
442	FM Electric Piano	FMEp
443	Digital Piano	DigiPn
444	E.Piano & Strings	EP&Str
445	E.Piano & Ac Guitar	EP&Gt
446	E.Piano & Vibraphone	Ep&Vib
447	E.Piano 2 & Pad	Ep2&Pad
448	E.Piano 2 & Strings	Ep2&Str
449	Harpichord & Stereo Strings	Haps&St
450	Music Box & Stereo Strings	Mxb&Str
451	Vibraphone & Stereo Strings	Vib&Str
452	Vibraphone Octave	VibOct
453	Vibraphone & Marimba & Kalimba	VibMK
454	Marimba & Kalimba	Mar&Kal
455	Marimba Delay	MarDel
456	Xylophone Octave	XylopOct
457	Organ & Stereo Strings	Org&Str
458	Stereo Organ & Piano	StOr&Pno
459	Rock Organ & Strings	RoOr&Str
460	Church Organ & Choir	ChuOr&Ch
461	Church Organ & Strings	ChuOr&St
462	Acoustic Guitar & Flute	Gt&Fl
463	Acoustic Guitar & Clav	Gt&Cl
464	24 String Guitar	24Gt
465	Steel Guitar & Warm Pad	StGt&Pad
466	Stereo Strings & Horn	StStr&Hn
467	Orchestra	Orchest
468	Full Strings	FullStr
469	Full Strings 2	FullStr2
470	Symphonic	Symphon
471	Stereo Choir & Strings	StCh&Str
472	Stereo Choir & Steel Guitar	Ch&Gt
473	3 Trumpet Loose	3Trump
474	Trombone & Stereo Strings	Tb&StStr
475	3 Trombones Loose	3Tromb
476	3 Muted Trumpets Loose	3MuTrumb
477	Club Brass	ClubBras
478	Brass & Woodwinds	Br&Wood
479	Woodwinds & Strings	Wind&Str
480	Section Woods Small	WoodSma
481	Pan Flute & Strings Pad	PanFu&St
482	Koto & Shamisen	Koto&Sh

483	Flute & Clarinet	Fl&Cl
484	Flute & Oboe	Fl&Ob
485	Flute & Bassoon	Fl&Bn
486	Flute & Oboe & Clarinet	Fl&Ob&Cl
487	Flute & Clarinet & Bassoon	Fl&Cl&Bn
488	Flute & Oboe & Bassoon	Fl&Ob&Bn
489	Flute Octave	FlOct
490	Flute & Oboe Octave	Fl&ObOct
491	Flute & Clarinet Octave	Fl&ClOct
492	Oboe & Bassoon	Ob&Bn
493	Oboe & Clarinet	Ob&Cl
494	Oboe & Clarinet & Bassoon	Ob&Cl&Bn
495	Oboe Octave	ObOct
496	Oboe & Clarinet Octave	Ob&ClOct
497	Oboe & Bassoon Octave	Ob&BnOct
498	Clarinet & Bassoon	Cl&Bn
499	Clarinet & Oboe Octave	Cl&ObOct
Drums		
500	Standard Set	Std Set
501	Room Set	Room Set
502	Power Set	PowerSet
503	Electronic Set	ElectSet
504	Analog Set	Ana Set
505	Jazz Set	Jazz Set
506	Brush Set	BrushSet
507	Orchestra Set	Orch.Set
508	SFX Set	SFX Set

Style List

NO.	Name	LCD Name
8BEAT		
1	8Beat Ballad	8BtBld
2	8Beat Piano	8BtPiano
3	8Beat 1	8Beat1
4	Guitar Pop 1	GtPop1
5	8Beat Hip Hop	8BtHiHop
6	8Beat Blues Rock	8BeatBIR
7	8Beat Pop	8BtPop
8	8Beat 2	8Beat2
9	Sweet Beat	SweetBt
10	8Beat 3	8Beat3
16BEAT		
11	16Beat 1	16Beat1
12	16Beat Funk 1	16BtFuk1
13	16Beat Ballad 1	16BtBld1
14	16Beat R&B	16BtR&B
15	Pop 16Beat 1	Pop16Bt1
16	16Beat Funk 2	16BtFuk2
17	16Beat Dance	16BtDanc
18	Pop 16Beat 2	Pop16Bt2
19	16Beat 2	16Beat2
20	Pop Shuffle	PopShfl
POP&BALLAD		
21	Pop Rock 1	PopRock1
22	Pop Dance	PopDanc
23	Pop Fusion	PopFusn
24	Analog Night 1	AnalgNt1
25	6/8 Pop	6/8Pop
26	Brit. Pop 1	BritPop1
27	Brit. Pop 2	BritPop2
28	Pop Hit	PopHit
29	Fusion Shuffle	FusShuffl
30	Analog Night 2	AnalgNt2
31	Guitar Pop 3	GtPop3
32	60's Pop	60'sPop
33	Guitar Ballad	GtBallad
34	Ballad Rock	BalladRk
35	Soft Ballad	SoftBald
36	Love Ballad	LoveBld
37	Easy Ballad	EasyBld
38	Slow Ballad	SlowBald
39	Pop Ballad 1	PopBld1
40	EP Ballad	EPBallad
ROCK		
41	Rock	Rock
42	New Wave	NewWave
43	Ska	Ska
44	Pop Rock 2	PopRock2
45	Slow Rock	SlowRock
46	70's Rock&Roll	70'sRock
47	Folk Rock	FolkRock
48	Soft Rock	SoftRock
49	Old Rock	OldRock
50	Easy Rock	EasyRock

NO.	Name	LCD Name
51	New Shuffle	NewShuffl
52	Rock Hip Hop	RkHipHop
53	Rock&Roll 1	R'N'R1
54	Rock Shuffle	RockShfl
55	Rock&Roll 2	R'N'R2
BALLROOM		
56	Tango 1	Tango1
57	Spain Matador	Matador
58	Twist 1	Twist1
59	Twist 2	Twist2
60	Big Band Fox	BandFox
61	Tango 2	Tango2
62	Slow Fox	SlowFox
63	Slow Waltz 1	SlowWlz1
64	Swing Fox	SwingFox
65	Salsa 1	Salsa1
66	Cha Cha 1	ChaCha1
67	Cha Cha 2	ChaCha2
68	Beguine 1	Beguine1
69	Beguine 2	Beguine2
70	Rumba 1	Rumba1
71	Samba 1	Samba1
72	Samba 2	Samba2
73	Jive	Jive
74	Fox Trot	FoxTrot
DANCE		
75	Techno 1	Techno1
76	Hip Hop 1	HipHop1
77	House 1	House
78	Down Beat	DownBeat
79	Progressive	Progress
80	Rap 1	Rap1
81	Disco	Disco
82	Disco Party	DscParty
83	70's Disco Funk	70'sFunk
84	Club Dance	ClubDanc
85	Euro Dance	EuroDanc
86	Garage	Garage
SOUL & FUNK		
87	Funk 1	Funk1
88	Classic Funk	ClasFunk
89	Jay R&B	JayR&B
90	Gospel Swing	GopSwing
91	Gospel	Gospel
92	Funk 2	Funk2
93	Electric Funk	ElecFunk
94	Groove Funk	GrooveFk
95	Rubber Funk	RubberFk
96	Cool Funky	ColFunky
97	Jazz Funk	JazzFunk
98	Groove	Groove
99	R&B	R&B
SWING & JAZZ		
100	Latin Jazz 1	LatinJz1

NO.	Name	LCD Name
101	Big Band	BigBand
102	Dixieland 1	Dixland1
103	Guitar Swing 1	GtSwing1
104	Broadway Big Band	BwayBand
105	Swing	Swing
106	Latin Jazz 2	LatinJz2
107	Fusion	Fusion
108	Acid Jazz	AcidJazz
109	Cool Jazz Ballad	CoolJzBd
110	Swing Shuffle	SwingSfl
111	Big Band Medium	BandMid
112	Dixieland 2	Dixland2
113	Acoustic Jazz	AcoustJz
114	Guitar Swing 2	GtSwing2
115	Ragtime	Ragtime
116	Modern Jazz Ballad	MdJzBald
117	Swing Ballad	SwingBal
118	Orchestra Swing	OrhSwing
COUNTRY		
119	Country Pop 1	CntyPop1
120	Bluegrass 1	Bluegrs1
121	8Beat Country	Ct8Beat
122	Modern Country	ModernCt
123	Country Pop 2	CntyPop2
124	Bluegrass 2	Bluegrs2
125	2/4 Country	2/4Cntry
126	Country Quick Steps	QuickStp
127	Country Folk	CntyFolk
128	Country Shuffle	CnyShuffl
LATIN & LATIN DANCE		
129	Bossa Nova	BosaNov
130	Latin	Latin
131	New Reggae	NewRegga
132	Reggae Dance	DanRegga
133	Paso Doble	Pasodobl
134	Lite Bossa	LteBossa
135	Latin Rock	LatinRck
136	Slow Bolero	SIBolero
137	Disco Samba	DscSamba
138	Mambo	Mambo
139	Meneito	Meneito
140	Rumba 2	Rumba2
141	Rumba 3	Rumba3
142	Salsa 2	Salsa2
WALTZ & TRADITIONAL		
143	Waltz	Waltz
144	Old Waltz	OldWaltz
145	English Waltz	EngWaltz
146	German Waltz	GemWaltz
147	Italian Mazurka	ItaMazuk
148	Mexico Waltz	MexWaltz
149	Vienna Waltz	VinaWtz
150	Slow Waltz 2	SlwWltz2

NO.	Name	LCD Name
151	Polka	Polka
152	6/8 March	6/8March
153	German Polka	GerPolka
154	Party Polka	PtyPolka
155	Army March	ArmMarch
156	March	March
157	March	March
158	US March	USMarch
159	Musette	Musette
160	French Musette	FMusette
	Mazurka	Mazurke
WORLD		
162	Enka Ballad	EnkaBald
163	Laendler	Laendler
164	Hawaiian	Hawaiian
165	Sirtake	Sirtake
166	Dangdut	Dangdut
167	6/8 Flipper	6/8Flipp
168	New Age	NewAge
169	Tarantella	Tarantel
	Scottish	Scottish
171	Norteno	Norteno
172		
173		
PIANIST		
174	Pianist 1	Pianist1
175	Pianist 2	Pianist2
176	Pianist 3	Pianist3
177	Piano Rock	PianoRk
178	Pop Bossa	PopBossa
179	Piano Beat	PianoBt
180	Piano Bar	PianoBar
	Blues	Blues
	Pop Waltz	PopWaltz
	6/8 Ballad	6/8Ballad

Song List

NO.	Name	LCD Name
FOLK & COUNTRY		
1	Toccata	Toccata
2	Carry Me Back To Old Virginny	CarMeBk
3	El Condor Pasa	ElCondor
4	Traumerei	Traumere
5	Aloha Oe	AlohaOe
6	Greensleeves	Sleeves
7	Home Sweet Home	SwHome
8	Heidenroslein	Heidenro
9	Long,Long Ago	LongAgo
10	Die Lorelei	Lorelei
11	Over The Waves	OverWave
12	My Darling Clementine	Clemnt
13	Gwine To Run All Night	Gwine
14	Symphony No.6 "Pathetic"	Sympony6
15	Oh! Susanna	Susanna
16	Prelude Op.28 No.15	Prelude
17	The House Of The Rising Sun	RiseSun
18	Menuet	Menuet
GOLDEN & POP		
19	Valse Des Fleurs	Fleurs
20	Fruhlingstimmen	Fruhling
21	Frohlicher Landmann	Landmann
22	Are You Lonesome Tonight?	RULone
23	Toy Symphony	ToySymph
24	Auld Lang Syne	AulSyne
25	Ave Maria	Avemaria
26	Tales Of Hoffman	Hoffman
27	La Donne Mobile	DoneMble
28	Serenata	Serenata
29	Bridal March	Bridal
30	Can'T Help Fallin' In Love	CantHlp
31	Chanson Du Toreador	Toreador
32	Danny Boy	DannyBoy
33	Ich Liebe Dich	LieDich
34	Wiegenlied 2	Wieglied2
35	Spanish Serenade	Serenade
36	Piano Concerto	Concerto
37	Piano Concerto 2	Concrcto2
38	Madame Butterfly	Madame
39	Invitation To The Dance	ToDance
40	Wiegenlied 3	Wieglied3
41	Jingle Bells	Jinbells
42	Joy To The World	JoyWorld
43	La Paloma	LaPaloma
44	My Bonnie	MyBonnie
45	La Reine De Saba	Saba
46	La Cucaracha	Cucarach
47	Little Brown Jug	BrownJug
48	Battle Hymne Of The Republic	BatlHyme
49	Yellow Rose Of Texas	YellRose
50	The Wabash Cannon Ball	CannBall
51	Annie Laurie	AnnieLa

NO.	Name	LCD Name
52	Turkish March	Turkish
53	An Die Musik	Musik
54	Lieder Ohne Worte Op.62 No.6	Lieder
55	Red River Valley	RedRiver
56	Die Forelle	Forelle
57	Symphony No. 94 "Suprise"	No. 94
58	Polonaise	Polonais
59	Rondeau	Rondeau
60	Moments Musicaux	Musicaux
61	Silent Night	Silnight
62	Moldau	Moldau
63	Summertime	Summer
64	Dreaming Of Home And Mother	Dreaming
65	Ring Ring De Banjo	DeBanjo
66	Der Lindenbaum	DerLinde
67	Zigeunerweisen	Zigeuner
68	The Maiden's Prayer	Prayer
69	Fur Elise	FurElise
70	Der Freischutz	DerFreis
71	Maria! Mari!	Maria!
CLASSICAL		
72	Waves Of The Danube	WaDanube
73	Santa Lucia	SantaLuc
74	Solveig's Song	Solveig
75	Pianosonatan 08 IN Cm IN Pathetique	Piano08
76	Brahms Waltz	BrmsWalz
77	Aida	Aida
78	Carmen-Prelude	Carmen2
79	L'Arlesienne	L'Arlesi
80	Ungarische Tanz	Ungaris
81	Mazurka	Mazurka
82	Pizzicato Polka	Polka
83	Menuett	Menuett
84	Rigoletto	Rigolett
85	Serenade	Serenade
86	Song Without Words	SongNoWd
87	Swan	Swan
88	Prelude To Act 2 (Swan Lake)	SwanLak1
89	Valse (Swan lake)	SwanLak2
90	The Happy Farmer	HpFarmer
91	The Sleeping Beauty	SleepBty
92	La Traviata	LaTravia
93	Wiegenlied	Wiegenli
94	Mov.2 Adagio Non Troppo Piano Sonata No.9 In D	Sonata9
95	Mov.1 Andante Grazioso Piano Sonata No.11 In A [Alla TurSonata11ca]	Sonata11
96	Prelude In C	Prelude
97	Chinese Dance	ChDance
98	Emperors Waltz	EmprWalz
99	March Militaire	MilMar1
100	Symphony No.40	Symphony

NO.	Name	LCD Name
PIANO		
101	Hanon Piano Fingering 1	Hanon 1
102	Hanon Piano Fingering 2	Hanon 2
103	Hanon Piano Fingering 3	Hanon 3
104	Hanon Piano Fingering 4	Hanon 4
105	Hanon Piano Fingering 5	Hanon 5
106	Basic Tutorial Beyer Piano12	Beyer 12
107	Basic Tutorial Beyer Piano13	Beyer 13
108	Basic Tutorial Beyer Piano14	Beyer 14
109	Basic Tutorial Beyer Piano15	Beyer 15
110	Basic Tutorial Beyer Piano18	Beyer 18
111	Cuckoo	Cuckoo
112	Basic Tutorial Beyer Piano21	Beyer 21
113	Basic Tutorial Beyer Piano29	Beyer 29
114	Butterfly	Buterfly
115	Basic Tutorial Beyer Piano45	Beyer 45
116	Christmas Eve	Chriseve
117	Basic Tutorial Beyer Piano50	Beyer 50
118	Basic Tutorial Beyer Piano52	Beyer 52
119	Basic Tutorial Beyer Piano55	Beyer 55
120	Basic Tutorial Beyer Piano59	Beyer 59

Demo List

NO.	Name	LCD Name
1	Demo	Demo
2	Bossa Nova	BosaNova
3	Fusion	Fusion
4	Jazz	Jazz
5	Funk	Funk

MIDI Implementation Chart

Function		Transmitted	Recognized	Remarks
Basic Channel	Default	1ch	1-16ch	
	Changed	1-16ch	1-16ch	
Mode	Default	x	3	
	Messages	x	x	
	Altered	*****	x	
Note Number		0—127	0—127	
	:True voice	*****	0—127	
Velocity	Note on	o 9nH,V=1-127	o 9nH,V=1-127	
	Note off	x (9nH,V=0)	x (9nH,V=0; 8nH,V=0-127)	
After Touch	key's	x	x	
	Ch's	x	x	
Pitch Bend		o	o	
Control Change	0	o	o	Bank Select
	1	o	o	Modulation
	5	x	o	Portamento Time
	6	x	o	Data Entry
	7	x	o	Volume
	10	x	o	Pan
	11	o	o	Expression
	64	o	o	Sustain Pedal
	65	x	o	Portamento ON/OFF
	66	x	o	Sostenuto Pedal
	67	x	o	Soft Pedal
	80	x	o	Reverb Program
	81	x	o	Chorus Program
	91	x	o	Reverb Level
	93	x	o	Chorus Level
	120	x	o	All Sound Off
	121	x	o	Reset All Controllers
123	o	o	All Notes Off	
Program Change	:true	*****	0—127	
System Exclusive		x	o	
System Common	:SongPosition	x	x	
	:Song Select	x	x	
	:Tune	x	x	
System Real Time	:Clock	o	x	
	:Commands	x	x	
Aux Messages	:LOCAL ON/OFF	x	x	
	:All Notes Off	x	o	
	:Active sense	o	o	
	:Reset	x	o	
Notes:				

- Mode 1: OMNI ON, POLY
- Mode 2: OMNI ON, MONO

- Mode 3: OMNI OFF, POLY
- Mode 4: OMNI OFF, MONO
- o: YES
- x: NO



We love music!

WEEE-Declaration

Your product is designed and manufactured with materials and components of high quality, which are recyclable and can be reused.

The symbol means that your product should be disposed of separately from household waste when it reaches its end of life.

Please dispose of this equipment at your local collection point or recycling center.

Please help to protect the environment in which we all live.

Intellectual property /Copyright

All specifications and appearances are subject to change without notice.

All information was correct at time of printing. Musikhaus Kirstein GmbH does not guarantee for the accuracy or completeness of any description, photograph or statement contained in this manual.

Printed colours and specifications may vary slightly from product. Products from Musikhaus Kirstein GmbH products are only sold through authorized dealers. Distributors and dealers are not agents of

Musikhaus Kirstein GmbH and have no authority to bind Musikhaus Kirstein GmbH legally in any way.

This manual is protected by copyright. Any copying or reprint, even in excerpts, is only allowed with written consent of Musikhaus Kirstein GmbH.

The same applies to reproduction or copying of images, even in altered form.



Musikhaus Kirstein GmbH
Bernbeurener-Str.11
D-86956 Schongau
Tel.0049-8861-909494-0
Fax:0049-8861-909494-19
www.kirstein.de



X-Keyboardständer einstrebig

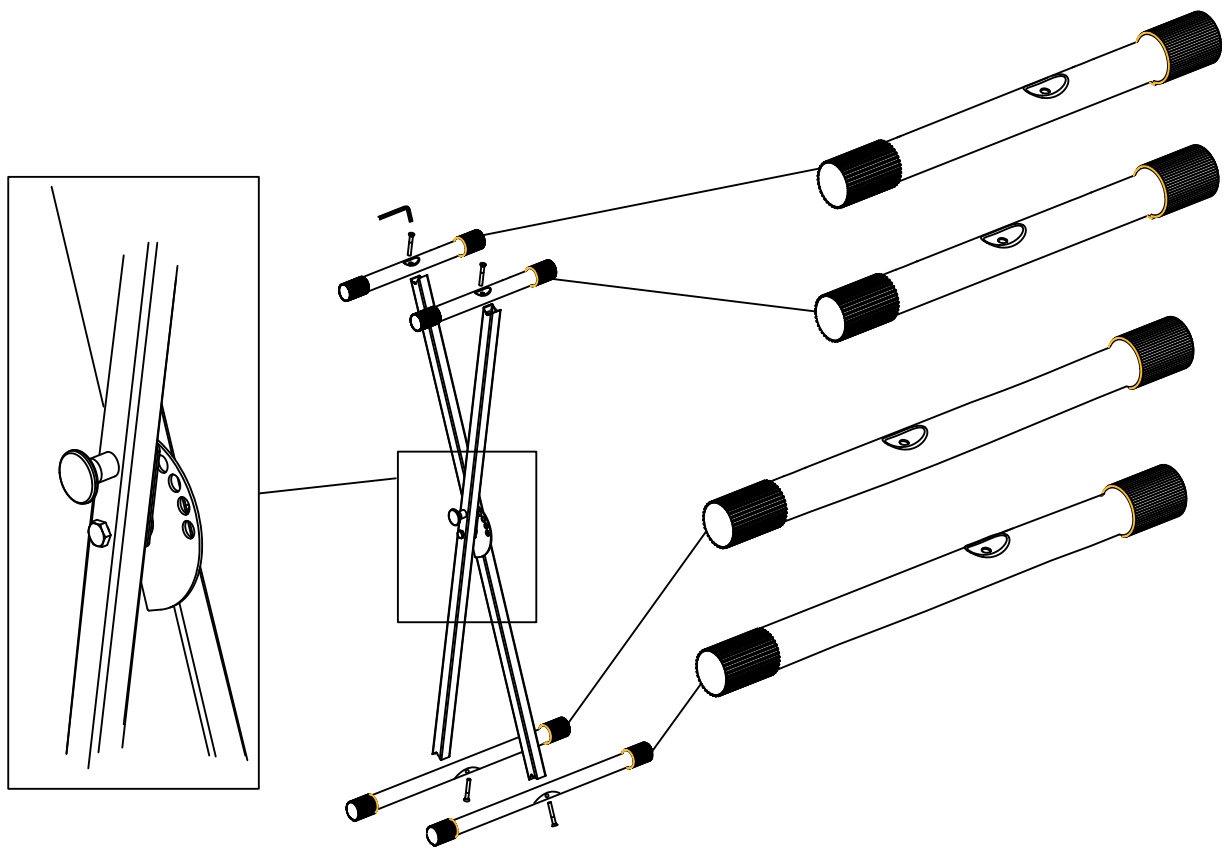

 **KIRSTEIN.de**
We love music!

Musikhaus Kirstein GmbH
Bernbeurener Str. 11
86956 Schongau
www.kirstein.de

Art. 00009812 /00062730
Version 10/2019