

INFORMATION FOR YOUR SAFETY!

THE FCC REGULATION WARNING (for USA)

This equipment has been tested and found to comply with the limits for a Class B digital device, pursuant to Part 15 of the FCC Rules.

These limits are designed to provide reasonable protection against harmful interference in a residential installation. This equipment generates, uses, and can radiate radio frequency energy and, if not installed and used in accordance with the instructions, may cause harmful interference to radio communications. However, there is no guarantee that interference will not occur in a particular installation. If this equipment does cause harmful interference to radio or television reception, which can be determined by turning the equipment off and on, the user is encouraged to try to correct the interference by one or more of the following measures:

- Reorient or relocate the receiving antenna.
- Increase the separation between the equipment and receiver.
- Connect the equipment into an outlet on a circuit different from that to which the receiver is connected.
- Consult the dealer or an experienced radio/TV technician for help.

Unauthorized changes or modification to this system can void the user's authority to operate this equipment.

CAUTION

The normal function of the product may be disturbed by Strong Electro Magnetic Interference. If so, simply reset the product to resume normal operation by following the owner's manual. In case the function could not resume, please use the product in other location.

PRECAUTIONS

PLEASE READ CAREFULLY BEFORE PROCEEDING

Please keep this manual in a safe place for future reference.

Power Supply

Please connect the designated DC adaptor to an AC outlet of the correct voltage.

Do not connect it to an AC outlet of voltage other than that for which your instrument is intended.

Unplug the DC power adaptor when not using the instrument, or during electrical storms.

Connections

Before connecting the instrument to other devices, turn off the power to all units. This will help prevent malfunction and / or damage to other devices.

Location

Do not expose the instrument to the following conditions to avoid deformation, discoloration, or more serious damage:

- Direct sunlight
- Extreme temperature or humidity
- Excessive dusty or dirty location
- Strong vibrations or shocks
- Close to magnetic fields

Interference with other electrical devices

Radios and televisions placed nearby may experience reception interference. Operate this unit at a suitable distance from radios and televisions.

Cleaning

Clean only with a soft, dry cloth.

Do not use paint thinners, solvents, cleaning fluids, or chemical-impregnated wiping cloths.

Handling

Do not apply excessive force to the switches or controls.

Do not let paper, metallic, or other objects into the instrument. If this happens, remove the electric plug from the outlet. Then have the instrument inspected by qualified service personnel.

Disconnect all cables before moving the instrument.

Panel & Display Description	
Front Panel.....	4
Rear Panel.....	5
Display.....	5
Setup	
Power Supply.....	6
Connections	
Connecting an MP3/CD Player.....	7
Connecting an Audio Equipment.....	7
Connecting a pair of Headphones.....	7
Connecting a Microphone.....	7
Connecting a Sustain Pedal.....	7
Connecting a Computer.....	7
Power Switch and Master Volume	8
Playing the Demos	8
Playing the Voices	
Playing a Voice.....	9
Playing Two Voice Simultaneously-DUAL.....	9
Playing Different Voices with Both hands-LOWER.....	9
Touch.....	9
Sustain.....	10
DSP Effect.....	10
Transpose.....	10
Octave.....	10
Key Light.....	10
Piano Mode.....	10
Auto Accompaniment	
Selecting a Style.....	11
Playing a Fill.....	11
Intro/Ending.....	11
Sync Start.....	12
Fade In/Out.....	12
Accompaniment Volume.....	12
Tempo.....	12
Auto Bass Chord.....	13
Chord Basics.....	13
One Touch Setting.....	14
Metronome	
Turning on the Metronome.....	14
Selecting the Beat.....	14
Arpeggiator	15
Mixer	15
Function Menu	
Tune.....	16
Octave.....	16
Split Point.....	16
Beat Type.....	17
Touch.....	17
Modulation.....	17
DSP.....	17
Reverb Type.....	17
Reverb Level.....	17
Chorus Type.....	18
Chorus Level.....	18
Auto Power Off.....	18
Key Light.....	18
Key Light Channel.....	18
Register Memory	19
Selecting a Registration Bank.....	19
Chord Dictionary	19
Playing the Songs	
Listening to the Songs.....	20
Lesson Mode.....	20
Recording and Playback	21
MIDI Function	
What's MIDI?.....	21
MIDI Connection.....	21
Trouble Shooting	22
Specifications	22
Appendices	
Voice List.....	23
Style List.....	28
Song List.....	30
MIDI Implementation Chart.....	32

Panel & Display Description

Front Panel

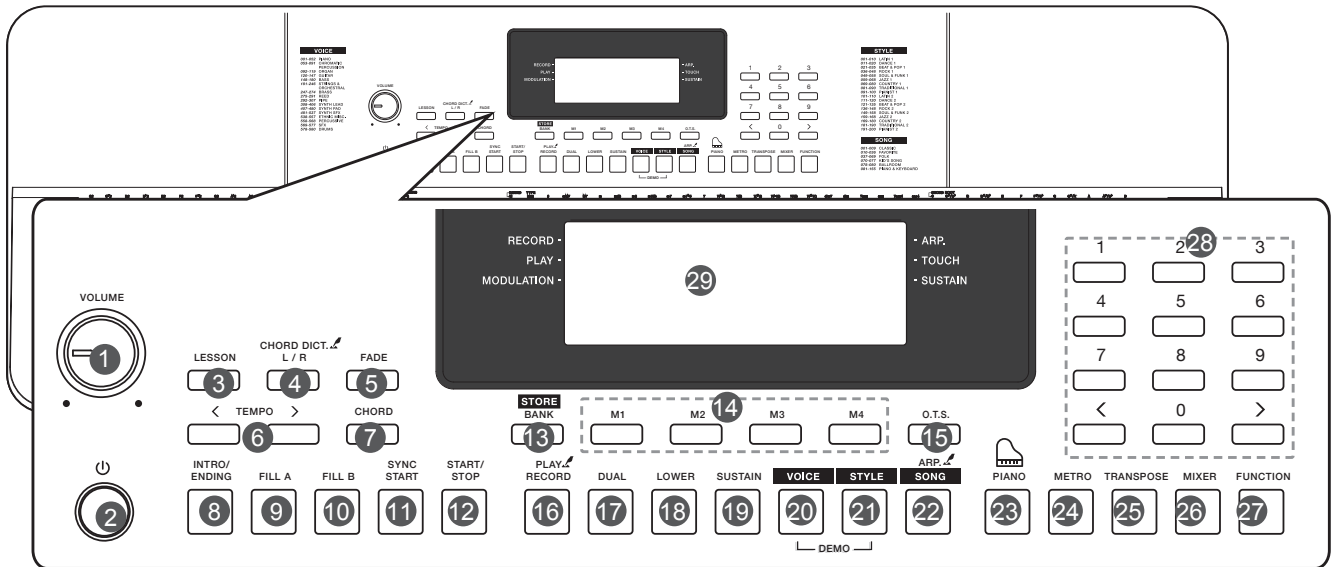

1. **[VOLUME] Knob**
Adjust the master volume.
2. **[] Button**
Turn the power on or off.
3. **[LESSON] Button**
Enter the lesson mode.
4. **[L/R] Button**
Choose to practice the left hand or right hand part.
[CHORD DICT.] Button
Turn the chord dictionary function on or off.
5. **[FADE] Button**
Turn the Fade In/Out function on or off.
6. **[TEMPO +/-] Buttons**
Adjust the current tempo value.
7. **[CHORD] Button**
Enter the Chord Mode.
8. **[INTRO/ENDING] Button**
Play the Intro or Ending pattern.
9. **[FILL A] Button**
Play the fill-in pattern A.
10. **[FILL B] Button**
Play the fill-in pattern B.
11. **[SYNC START] Button**
Turn the Sync Start function on or off.
12. **[START/STOP] Button**
Start or stop playing the style or song.
13. **[BANK] Button**
Switch between memory banks.
[STORE] Button
Register the current panel settings.
14. **[M1]~[M4] Buttons**
Recall the registered panel settings.
15. **[O.T.S.] Button**
Turn the One Touch Setting function on or off.
16. **[RECORD] Button**
Enter the Record Mode.
[PLAY] Button
Play back the recording.
17. **[DUAL] Button**
Turn the dual function on or off.
18. **[LOWER] Button**
Turn the lower function on or off.
19. **[SUSTAIN] Button**
Turn the sustain function on or off.
20. **[VOICE] Button**
Switch to Voice Mode.
Press [VOICE] and [STYLE] at the same time to enter Demo Mode.
21. **[STYLE] Button**
Switch to Style Mode.
Press [VOICE] and [STYLE] at the same time to enter Demo Mode.
22. **[SONG] Button**
Switch to Song Mode.
[ARP.] Button
Turn the Arpeggiator function on or off.
23. **[PIANO] Button**
Turn the Piano Mode on or off.
24. **[METRO] Button**
Turn the metronome on or off.
25. **[TRANPOSE] Button**
Adjust the Transpose value.
26. **[MIXER] Button**
Enter the Mixer menu.
27. **[FUNCTION] Button**
Enter the function menu.
28. **[+]/[-] and Number Buttons**
Set parameters value or select the number.
29. **LCD Display**
Display all parameters and values related to the current operation.

Rear Panel

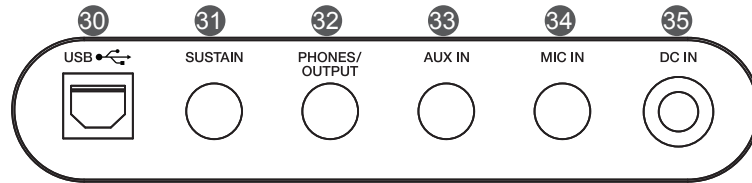

30. USB Jack

Connect to a computer.

31. SUSTAIN Jack

Connect a sustain pedal.

32. PHONES/OUTPUT Jack

Connect a pair of headphones or an audio equipment.

33. AUX IN Jack

Connect an external audio source, such as MP3 or CD player.

34. MIC Jack

Connect a microphone.

35. DC IN Jack

Connect the DC 12V power adapter.

Display

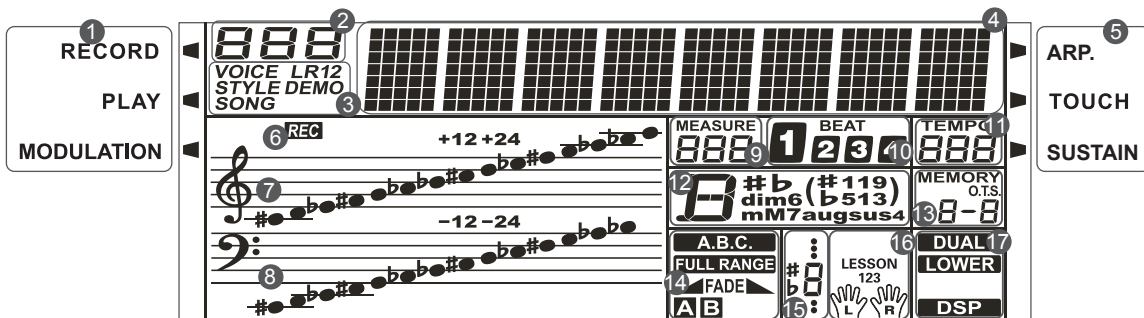

1. RECORD/PLAY/MODULATION

2. NUMBER

3. VOICE/STYLE/DEMO/SONG

4. CHARACTER

5. ARP/ TOUCH/SUSTAIN

6. RECORD

7. TREBLE CLEF

8. BASS CLEF

9. MEASURE

10. BEAT

11. TEMPO

12. CHORD

13. MEMORY/O.T.S.

14. A.B.C./FULL RANGE/FADE/A/B

15. NOTE INDICATION

16. LESSON

17. DUAL/LOWER/DSP

Setup

This section contains information about setting up your instrument and preparing to play. Please go through this section carefully before turning the power on.

Power Supply

You can power the instrument either by batteries or by power adaptor. Follow the instructions described below.

Using Batteries

The instrument needs 6 pieces of AA (NO.5) or equivalent alkaline batteries for power supply.

1. Open the battery cabinet cover located on the bottom of the instrument.
2. Insert the batteries, carefully following the polarity markings on the cabinet.
3. Replace the cabinet cover. Make sure it locks firmly in place.

Notes:

1. Do not mix using any used and new batteries.
2. Always use the same types of batteries.
3. Remove the batteries when the instrument is not in use for a long period of time.

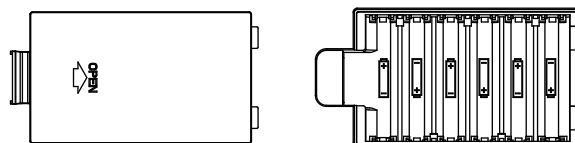

Using Power Adaptor

1. Turn down the volume before connecting to power supply.
2. Connect the adaptor to the DC IN jack of the instrument.
3. Plug the adaptor into an AC outlet. This will automatically cut off the battery power supply.

Notes:

1. In order to save energy, the instrument will automatically shut down after 15 minutes if it is not used. (Please refer to **Auto Power Off**).
2. For your safety, please unplug the instrument when it is not in use or during a thunderstorm.

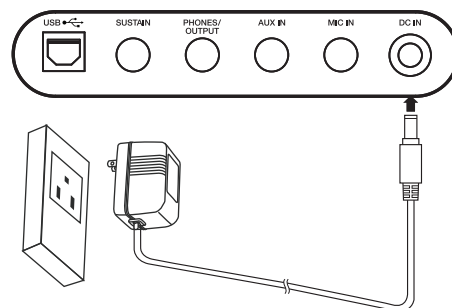
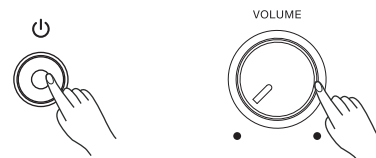

Connecting an MP3/CD Player

The rear-panel AUX IN jack receives audio signals from an external audio source such as an MP3 or a CD player.

Use an audio cable to connect the AUX IN jack of the instrument to the OUTPUT jack of the MP3/CD player. The instrument's speakers will play the music transmitted from the external player, and you can play along.

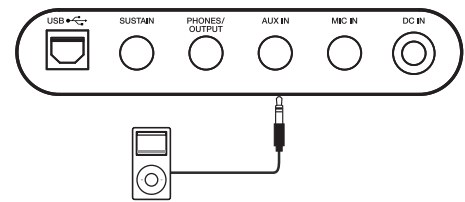

Connecting an Audio Equipment

The rear-panel PHONES/OUTPUT jack delivers the output of the instrument to an external audio equipment such as a keyboard amplifier, a stereo sound system, a mixing console, or a recorder. Use an audio cable to connect the PHONES/OUTPUT jack of the instrument to the INPUT jack of the external audio equipment.

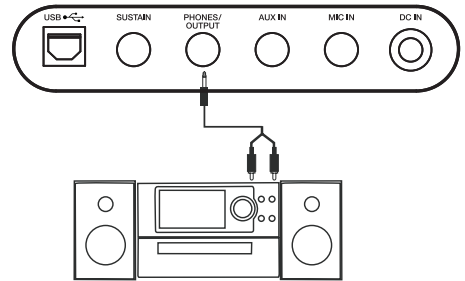

Notes:

1. Turn off the power to all units before connecting or disconnecting the external equipment.
2. To avoid damaging the speakers, please set the master volume to minimum level before turning on the power.

Connecting a pair of Headphones

A standard pair of stereo headphones can be connected to the PHONES/OUTPUT jack for private practice or late-night playing.

The internal stereo speaker system is automatically shut off when a pair of head phones is plugged into this jack.

Note:

Do not listen with the headphones at high volume for long periods of time. Doing so may cause hearing loss.

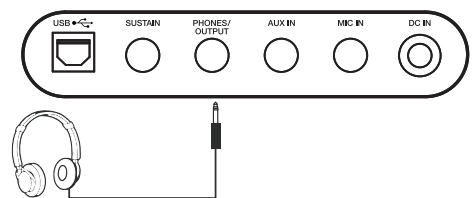

Connecting a Microphone

You can plug a microphone to the MIC jack to sing along with your keyboard performance or song playback.

1. Set the master volume to minimum level before connecting or disconnecting a microphone.
2. Plug a microphone into the MIC jack.
3. Adjust the master volume to an appropriate level.

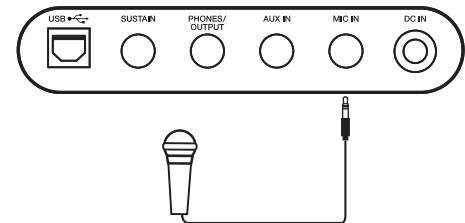

Connecting a Sustain Pedal

An optional footswitch can be plugged into the sustain jack and be used to switch sustain on or off. Simply by pressing the pedal, you will have a natural sustain as you play.

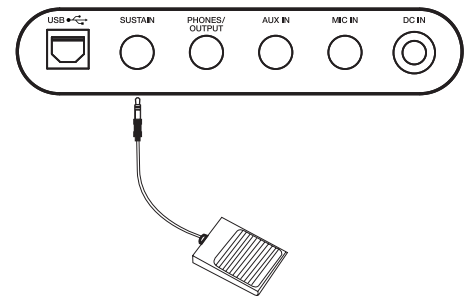

Connecting a Computer

Use a standard USB cable to connect the USB jack of the instrument to the USB port of a computer. You can transmit MIDI messages between the instrument and the computer.

Notes:

1. Do not set the USB device to be input and output simultaneously when setting the software on the computer. Otherwise, the sound will be overlapped when playing the keyboard.
2. We recommend using a USB2.0 interface to connect the instrument to computer.

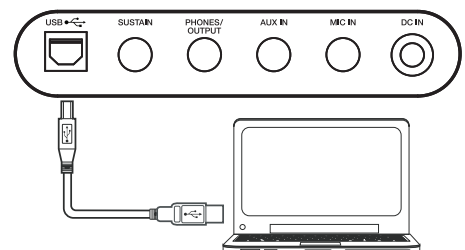

Power Switch and Master Volume

Power Switch

Before you switch your instrument on, please turn down the volume of instrument and the connected audio equipment first.

1. Make sure the instrument is properly connected to power supply.
2. Press POWER SWITCH, the LCD screen is lit, and displays "Loading!", indicating the instrument is powered on.

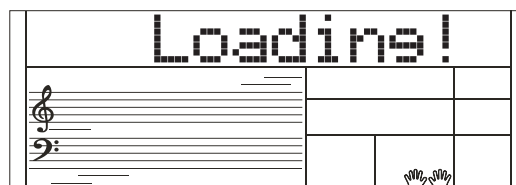
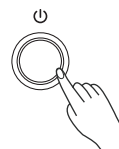

Master Volume

Rotate the [VOLUME] knob clockwise to increase the master volume or counter-clockwise to decrease it. You can use the knob to set the desired volume level.

Note:

If the speakers do not produce sound, please check if the master volume is set too low or if headphones are plugged into the PHONES jack.

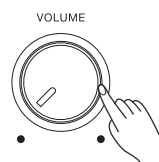

Playing the Demos

The instrument features a variety of demo songs.

1. Press the [STYLE] and [VOICE] buttons simultaneously to start playing all demo songs in a loop. The LCD will display the current demo number and name.
2. Select a demo song.
Use the number keys, the [+]/[-] buttons to select the desired demo song.
3. Press the [STYLE] and [VOICE] buttons simultaneously again or press the [START/STOP] button to stop playing and exit the demo mode.

Note:

During demo playback, only the following buttons will work: [START/STOP], [TEMPO -]/[TEMPO +], [+]/[-], the Number buttons, [VOLUME] and [POWER].

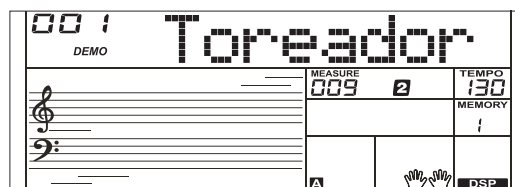
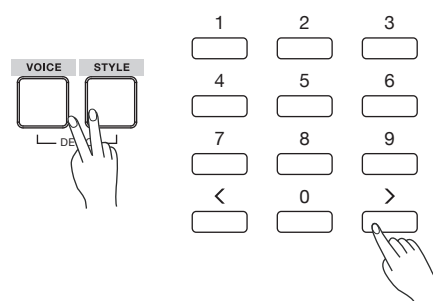

Playing the Voices

The instrument features a variety of exceptionally realistic voices. Please refer to Voice List.

Playing a Voice

1. Press the [VOICE] button.
Enter the VOICE mode. LCD shows "VOICE R1", the voice number and the voice name.
2. Select a voice.
Use the number keys, the [+]/[-] buttons to select the voice you want to play.
3. Play the voice.
Play the keyboard and enjoy the beautiful voice.

Note:

When the DUAL and LOWER function is on, you can press [VOICE] button repeatedly to choose the voice source. The corresponding LCD indicator will highlight between R1, R2, and L.

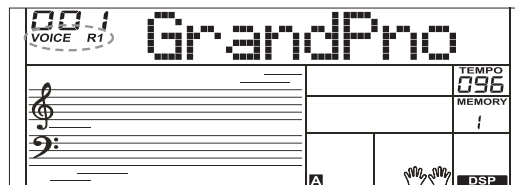
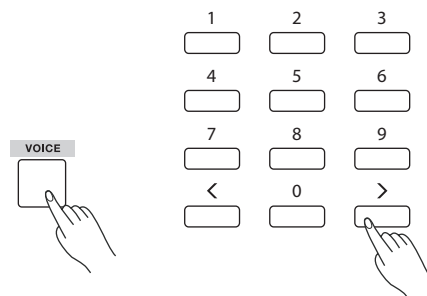

Playing Two Voice Simultaneously-DUAL

1. Press the [DUAL] button to turn on the dual function. LCD shows "VOICE R 2", the dual voice number and name.
2. Use the number keys, the [+]/[-] buttons to select a voice for VOICE R2.
3. Play the keyboard, you will hear two different voices layered together, just like two different instruments being played at the same time.
4. Press the [DUAL] button again to turn off the dual function.

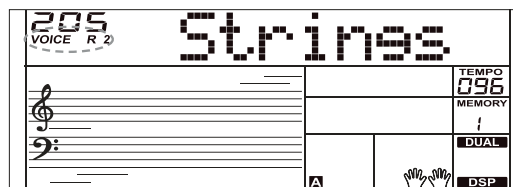
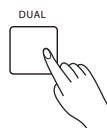

Playing Different Voices with Both hands-LOWER

The Lower function splits the keyboard into two areas so as to create different voices for each of your hands. The left hand voice is the lower voice "L".

1. In idle mode, press the [LOWER] button to turn the lower function on.
The LCD displays the left hand voice name and number, and the indicator "VOICE L" and "LOWER".
2. Use the number keys, the [+]/[-] buttons to select a voice for VOICE L.
3. Play the keyboard with both hands, and you will hear two different voices.
4. Press the [LOWER] button again to turn off the lower function.

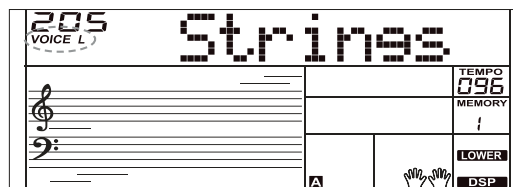
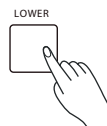

Split Point

The key on the keyboard that separates voice L and voice R1/R2 is called the "split point". The default split point is at F#3 (19), however you can assign it to any other key. Refer to the Function Menu.

Touch

The keyboard is equipped with a touch response feature that lets you dynamically and expressively controls the level of the voice with your playing strength – just as on an acoustic instrument. Please refer to the function menu to adjust the touch level.

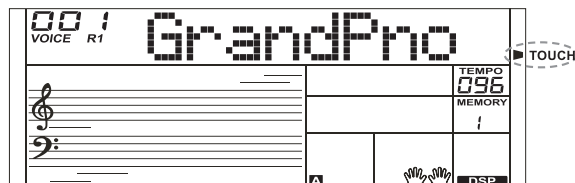

Playing Voices

Sustain

When the Sustain feature is ON, all notes played on the keyboard will have a longer sustain. Press the [SUSTAIN] button to turn sustain on or off.

Note:

When using a sustain pedal, you can produce a much stronger and more natural sustain effect than by using the [SUSTAIN] button.

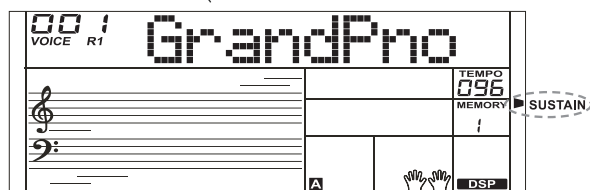

DSP Effect

The DSP simulates sounds in real environment. With the DSP effects, you can add ambiance and depth to your performance in a variety of ways.

The function is turned on by default. You can refer to the function menu to turn the DSP effect on or off.

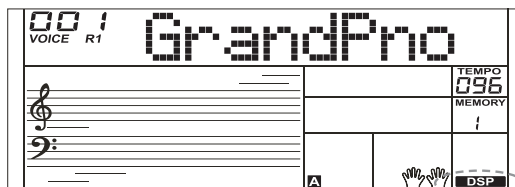

Transpose

Transpose function allows the overall pitch of the instrument to be transposed up or down by one octave in semitone steps.

1. the [TRANPOSE] button to enter transpose menu. The LCD shows the current transpose value.
2. Use [+] / [-] buttons to adjust the transpose value.
3. Press the [+] and [-] buttons simultaneously to reset the transposition to 0.

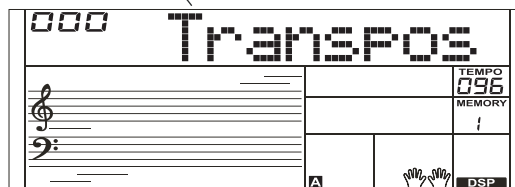
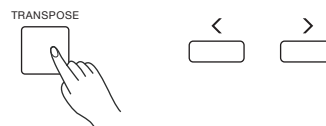

Octave

The octave function will shift the pitch of the specified voice layer up or down in the step of an octave.

You can refer to the function menu to adjust the octave value.

Note:

After adjusting the octave, notes in the highest and lowest keyboard range may not sound normally.

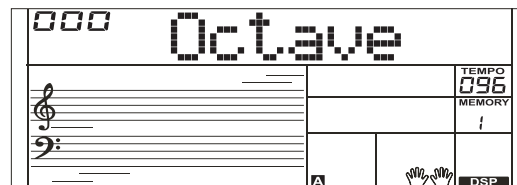

Key Light

When playing the keyboard or playing a song, the keys on the keyboard will blink along.

You can refer to the function menu to turn the key light on or off.

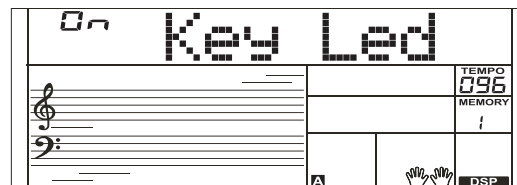

Piano mode

This function is to set the voice of the entire keyboard to piano instantly.

1. Press [PIANO] button to enter or exit piano mode.
2. In piano mode, you can play the accompaniment as in the other modes, but it plays only the rhythm part.

Note:

In piano mode, the A.B.C. is automatically turned off.

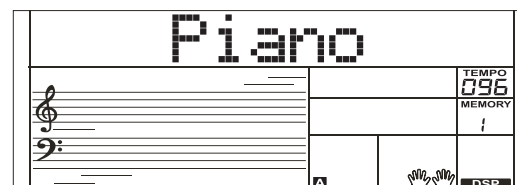
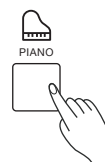

Auto Accompaniment

The auto accompaniment function puts a full backing band at your fingertips. All you have to do is to play chords with your left hand, and the accompaniment will automatically play along, instantly following the chords you play. With auto accompaniment, even a solo performer can enjoy playing with the backing of an entire band or orchestra. The instrument features a variety of styles, please refer to the Style List. Try selecting the different styles and enjoy the auto accompaniment.

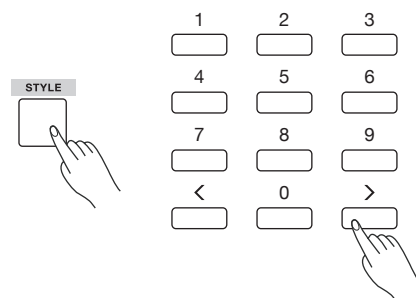

Selecting a Style

1. Press the [STYLE] button.
Enter the STYLE mode. LCD shows "STYLE", the style number and the style name.
2. Use the number keys, the [+]/[-] buttons to select the style you want to play.
3. Press the [START/STOP] button to start the rhythm tracks of the auto accompaniment.

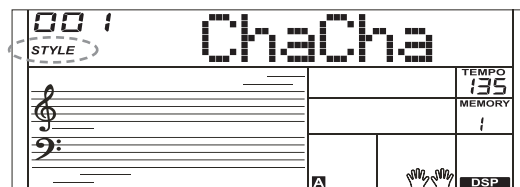

Sync Start

When style stops, press the [SYNC START] button to turn on the function. The beats on LCD will flash along with the tempo.

1. In Sync Start mode, if the A.B.C. function is turned off, you can press a key on the keyboard to start playing auto accompaniment of the rhythm track.
2. In Sync Start mode, if the A.B.C. function is in use, you can press a key on the chord range of the keyboard to start playing auto accompaniment of all tracks.

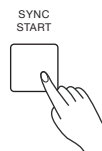

Intro/Ending

The intro is an opening section of a song. When the intro pattern finished, the system will automatically shift to the main section.

Ending is the ending section of a song. When the ending is finished, accompaniment automatically stops. The length of the ending differs depending on the selected style.

1. Press the [STYLE] button.
2. Select a style.
3. Turn the Chord Mode on.
4. Turn SYNC START on.
5. Press the [INTRO/ENDING], the "A" or "B" flashes on LCD, the style is ready to play.
6. It will start the accompaniment as soon as you start playing in Chord section. When the playback of the intro is finished, it automatically switched to main A or B section.
7. Press the [INTRO/ENDING] again to play the ending section.
When the ending is finished, the auto accompaniment automatically stops.

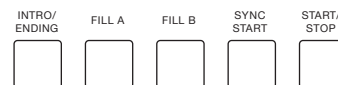
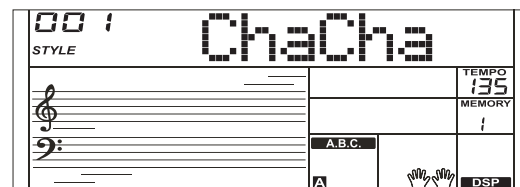
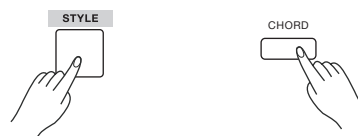

Note:

If you press [FILL A] or [FILL B] before the ending is finished, it will play a fill-in then switch to the corresponding main section.

Auto Accompaniment

Playing a Fill

Auto fill in function automatically adds a fill to your performance. When the fill-in is finished, accompaniment shifts to the Main section (A,B).

Note:

If you keep pressing [FILL A]/[FILL B] buttons during style playback, the fill-in pattern will repeat playing until the button is released. Playback will then shift to the related MAIN section.

When style stops, press the [FILL A]/[FILL B] buttons to select a MAIN section. "A or B" will highlight on LCD.

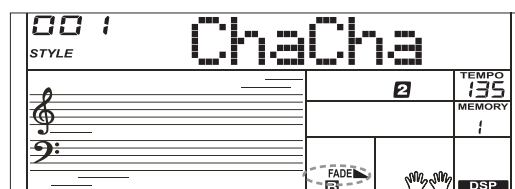
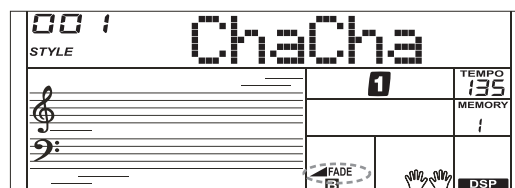
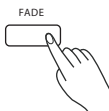
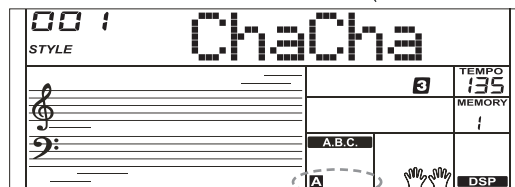
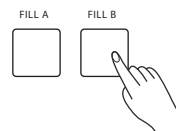

Fade In/Out

Fade In

Starting the style with fade in produces a smooth beginning, the volume increases from low to high. Press the [FADE] button when Style is stopped, LCD will show FADE. Press the [START/STOP] button to start Style playing. LCD will show ▲FADE.

The Accompaniment Volume will change from 0 to the set value in about 8 seconds. The keyboard volume will change from 0 to default value at the same time.

Fade Out

Stopping the style with fade out produces a smooth ending, the volume decreases from high to low. Press the [FADE] button during Style playing. LCD will show FADE ▽.

The Accompaniment Volume will change from the set value to 0 in about 8 seconds, and the style stops.

Accompaniment Volume

The function adjusts the accompaniment volume, so as to keep an appropriate balance between the accompaniment volume and the voice volume.

Press repeatedly the [MIXER] button to enter the mixer menu, and when the LCD displays "Accomp", you can adjust the volume level over the range of 0-32. LCD will show the current volume level.

Notes:

In the mixer menu, press both [-] and [+] buttons simultaneously to mute the accompaniment part. LCD shows "OFF Accomp". Press both buttons again to unmute the accompaniment volume.

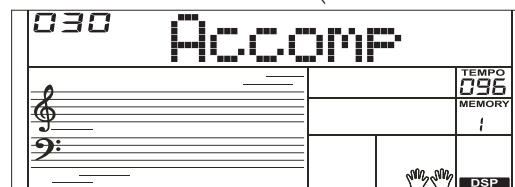

Tempo

Each style of the instrument has been programmed with a default tempo; however, you can change it as needed.

1. Use the [TEMPO -]/[TEMPO +] buttons to change the tempo. The value ranges from 5 to 280.
2. Hold down the [TEMPO -]/[TEMPO +] buttons to change the tempo quickly.
3. Press the [TEMPO+] and [TEMPO-] buttons simultaneously to restore the default tempo setting.

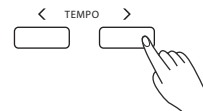

Auto Bass Chord

1. Press the [CHORD] button, the LCD will display the "A.B.C." indicator. The left hand section of the keyboard is the chord section. You can play different chords in the chord section.

Press [CHORD] button again to enter Full Range mode. The "FULL RANGE" indicator will be lit. You can play chords over the entire keyboard in multi-fingering.

2. Play chords in the chord section, and the LCD will display the corresponding chord names.

3. Split Point Setting
Please refer to the function menu to set the split point. The split point and the keys to its left all belong to the chord section.

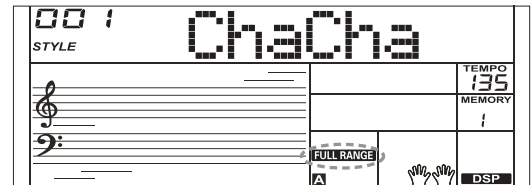
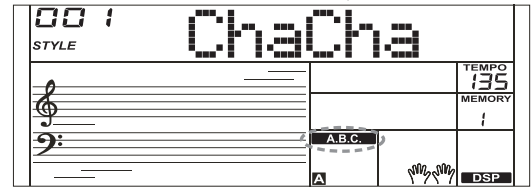
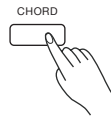

Chord Basics

A chord, in music, is any harmonic set of three or more notes that is heard as if sounding simultaneously. The most frequently encountered chords are triads. A triad is a set of three notes that can be stacked in thirds. When stacked in thirds, the triad's members, from lowest pitched tone to highest, are called: the Root, the Third, and the Fifth.

Triad Type

There are following basic triad types:

Major Triad	A root with a major third added above and a perfect fifth will consist as a "Major Triad".
Minor Triad	A root with a minor third added above and a perfect fifth will consist as a "Minor Triad".
Augmented Triad	A root with a major third added above and an augmented fifth will consist as an "Augmented Triad".
Diminished Triad	A root with a minor third added above and a diminished fifth will consist as a "Diminished Triad".

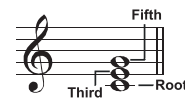

Major Triad Minor Triad



Diminished Triad Augmented Triad



Root Position First Inversion Second Inversion

Chord Inversion

We define this chord its root is not in the bass (i.e., is not the lowest note) as an inversion chord. When the root is in the bass, we call the chord: root-position chord. If we put the Third and Fifth in the root position, then it forms "Inversion", we call this chord "Inversion Chord". See the following major triad and its inverted chord.

Chord Name

The chord name contains two parts content: Chord root and Chord type.

Single Finger

Single finger type not only can detect single finger but also can detect multi finger. And the single finger makes it easily to play chords through only one, two or three keys. Including major, minor, seventh, and minor seventh chord. Refer to relevant picture on the right for details.

Cm

Chord Root Chord Type

C		Major Triad Only press the root note on the keyboard.
Cm		Minor Triad Press the root note and the nearest left black key simultaneously.
C7		Seventh chord Press the root note and the nearest left white key simultaneously.
Cm7		Minor seventh chord Press the root note and the nearest left white and black keys simultaneously.

Auto Accompaniment

Multi-finger

Multi-finger allows you to play chords in normal fingering. Try playing the 32 chord types in C scale as listed on the right.

Note:

In full range mode, the entire keyboard will only recognize chords played in normal fingering.

0 C	1 C ₆	2 C _{M7}	3 C _{M7} (#11)	4 C _M (9)	5 C _{M7} (9)
6 C ₆ (9)	7 C _{aug}	8 C _m	9 C _{m6}	10 C _{m7}	11 C _{m7} (b5)
12 C _m (9)	13 C _{m7} (9)	14 C _{m7} (11)	15 C _m M ₇	16 C _m M ₇ (9)	17 C _{dim}
18 C _{dim7}	19 C ₇	20 C ₇ SUS4	21 C ₇ (b5)	22 C ₇ (9)	23 C ₇ (#11)
24 C ₇ (13)	25 C ₇ (b9)	26 C ₇ (b13)	27 C ₇ (#9)	28 C _{M7} AUG	29 C ₇ AUG
30 C _{SUS4}	31 C ₁₋₂₊₅	Notes enclosed in parentheses are optional; the chords could be recognized without them.			

One Touch Setting

When One Touch Setting is switched on, you can instantly recall all auto accompaniment related settings including voices selection and digital effects simply with a single touch of a button.

1. Press the [O.T.S.] button to turn on the One Touch Setting for current style. LCD shows "O.T.S."
2. Press one of the [M1]-[M4] buttons, various panel settings (such as voice, effect, etc.) that match the selected style can be instantly recalled.
3. A.B.C. is automatically turned on during O.T.S. mode.
4. Press the [O.T.S.] button again to quit One Touch Setting mode, the "O.T.S." indicator will disappear.

Note:

In O.T.S. mode, the memory is not selectable.

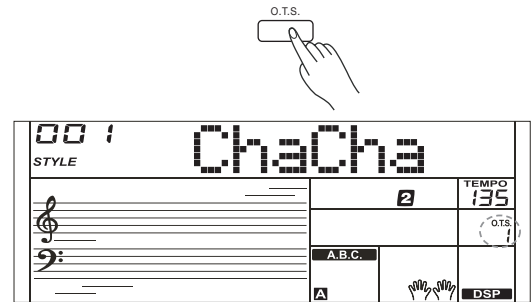

Metronome

Turning on the Metronome

Press the [METRO] button to turn on the metronome.
Press the [METRO] button again to turn off the metronome.
Press the [TEMPO+] / [TEMPO-] buttons to change the tempo of the metronome.



Selecting the Beat

You can set the beat type in the function menu, please refer to the function menu for details.

If you turn on the metronome during style playback, the metronome sound will start from the next beat and its beat will match the current style. When style stops, you can change the metronome beat as desired.

The metronome is not usable in song mode.

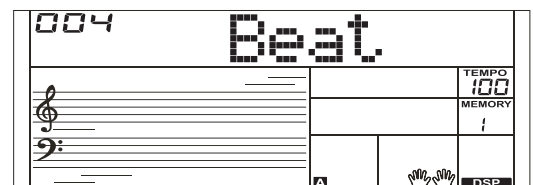

Arpeggiator

The arpeggiator function will automatically generate arpeggios. Simply play a chord with your left hand, and the instrument will play a preset arpeggio pattern to produce a beautiful melody.

Turn the Arpeggiator on or off

Press and hold the [ARP.] button for 2 seconds to turn on the function. The corresponding indicator will be lit. Press and hold the [ARP.] button for 2 seconds again to turn off the function. The corresponding indicator will light off.

Note:

Each voice is matched with a preset arpeggio pattern, so when you change the voice, the default arpeggio pattern will change as well.

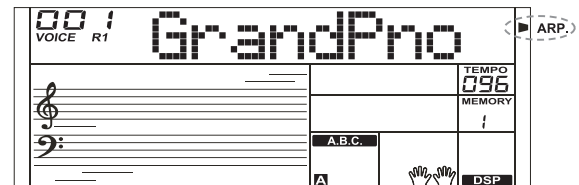

The Split Point of Arpeggiator

When you turn on the arpeggiator, the keyboard will be split into two areas. Play chords in the left hand area, and melody in the right hand area. The default split point is the same as in the lower function: F#3 (19).

Mixer

The Mixer allows you to adjust separately the volume of different tracks.

1. Press the [MIXER] button to enter the mixer menu, the LCD displays the current mixer track.
2. Repeatedly press the [MIXER] button to select the track you want. Then use [+] / [-] buttons to change the parameters.

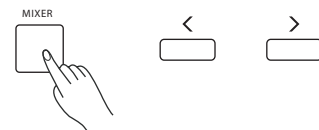

The option and parameters are as follows:

Options	LCD Display	Range
Adjust the Accompaniment volume	XXX Accomp	0-32
Adjust the Rhythm track volume	XXX Rhythm	0-32
Adjust the Bass track volume	XXX Bass	0-32
Adjust the Chord 1 track volume	XXX Chord1	0-32
Adjust the Chord 2 track volume	XXX Chord2	0-32
Adjust the Chord 3 track volume	XXX Chord3	0-32
Adjust the Upper 1 track volume	XXX Upper 1	0-32
Adjust the Upper 2 track volume	XXX Upper 2	0-32
Adjust the Lower track volume	XXX Lower	0-32

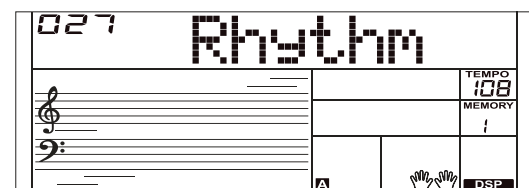

Note:

It will exit the mixer menu if there is no operation in 3 seconds. Pressing [+] and [-] buttons at the same time will mute the selected track, the LCD will display "OFF". Press the two buttons at the same time again to unmute the track.

Function Menu

Press the [FUNCTION] button to enter the function menu. The LCD displays the current parameter item.

Press repeatedly the [FUNCTION] button to select an item, then use the [+] / [-] buttons to change the value of the selected item.

Parameter items and the value range in the function menu:

Parameter Item	LCD Display	Range
Tune	XXX Tune	-50 - +50
Octave	XXX Octave	-2 - +2
Split Point	XXX Split Pt	1 - 61
Beat Type	XXX Beat	0, 2 - 9
Touch	XXX Touch	OFF, 1 - 3
Modulation	XXX Modul	On, OFF
DSP	XXX Dsp	On, OFF
Reverb Type	XXX Rev Type	1 - 10
Reverb Level	XXX Rev Lev	0 - 32
Chorus Type	XXX Chr Type	1 - 8
Chorus Level	XXX Chr Lev	0 - 32
Auto Power Off	XXX PowerOff	OFF, 15, 60
Key Light	XXX Key Led	On, OFF
Key Light Channel	XXX ChIn Led	ALL, 1 - 16

Note:

It will exit the function menu if there is no operation in 3 seconds.

Tune

The function adjusts the pitch of the entire keyboard in a 2-cent increment.

1. Repeatedly press the [FUNCTION] button to select the tune menu.
The LCD displays "Tune".
Use the [+] / [-] buttons to change the value over the range of -50 - +50.
2. Pressing [+] and [-] buttons at the same time will reset the tune value to default "000".
The setting applies to both accompaniment and the voice.

Octave

1. Repeatedly press the [FUNCTION] button to select the octave menu.
The LCD displays "Octave".
Use the [+] / [-] buttons to change the value over the range of -2 - +2.
2. Pressing [+] and [-] buttons at the same time will reset the octave value to default "000".

Split Point

The Point on the keyboard that separates voice L and voice R1/R2 is called the "split point". Left hand section controls the auto bass chord accompaniment when the A.B.C. function is on, or it plays the lower voices when the A.B.C. function is off.

1. Repeatedly press the [FUNCTION] button to select split point menu.
The LCD displays "Split Pt". Use [+] / [-] buttons to change Split Point.
The range of Split Point is: 1~61.
2. Press [+] / [-] buttons simultaneously will set the split point value to its default setting: F#3 (19).

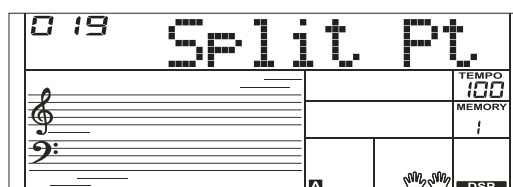
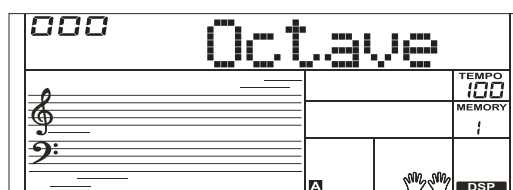
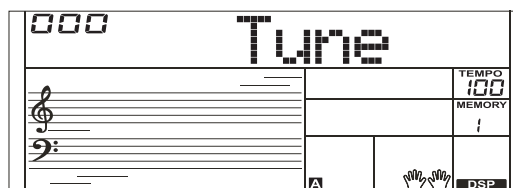
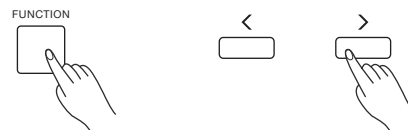

Beat Type

1. Repeatedly press the [FUNCTION] button to select the beat menu. The LCD displays "Beat". Use the [+] / [-] buttons to change the beat type.
2. Pressing [+] and [-] buttons at the same time will reset the beat type to default "004".

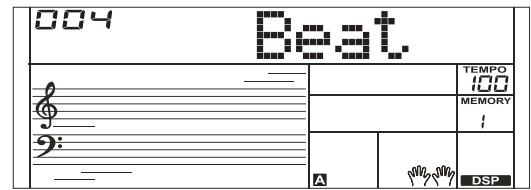

Touch

1. Repeatedly press the [FUNCTION] button to select the touch menu. The LCD displays "Touch". Use the [+] / [-] buttons to change the touch level.
2. Pressing [+] and [-] buttons at the same time will reset the touch level to default "002".

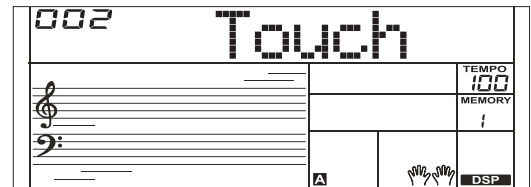

Modulation

- Repeatedly press the [FUNCTION] button to select the modulation menu. The LCD displays "Modul". Use the [+] / [-] buttons to switch modulation on or off.

Note:

Modulation is not available for percussive voices.

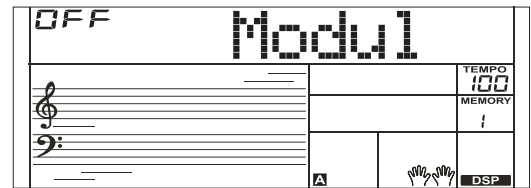

DSP

- Repeatedly press the [FUNCTION] button to select the DSP menu. The LCD displays "Dsp". Use the [+] / [-] buttons to switch DSP on or off.

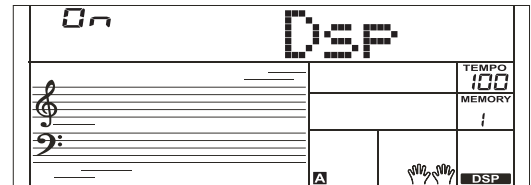

Reverb Type

1. Repeatedly press the [FUNCTION] button to select the reverb type menu. The LCD displays "Rev Type". Use the [+] / [-] button to change the type value.
2. Pressing [+] and [-] buttons at the same time will reset the reverb type to default "004".

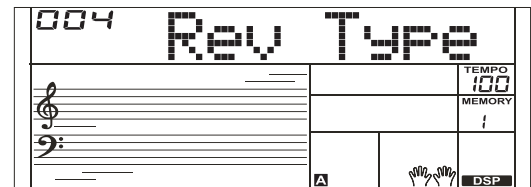

Reverb Level

1. Repeatedly press the [FUNCTION] button to select the reverb level menu. The LCD displays "Rev Lev". Use the [+] / [-] button to adjust the level over the range of 0-32.
2. Pressing [+] and [-] buttons at the same time will reset the reverb level to default.

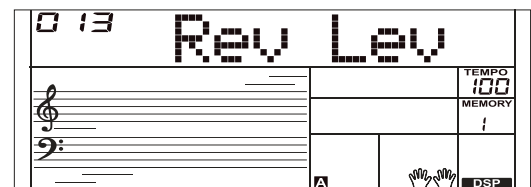

Function Menu

Chorus Type

1. Repeatedly press the [FUNCTION] button to select the chorus type menu. The LCD displays “Chr Type”.
Use the [+] / [-] button to change the type value.
2. Pressing [+] and [-] buttons at the same time will reset the chorus type to default “003”.

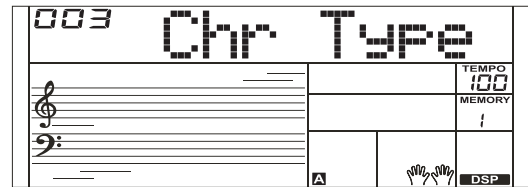

Chorus Level

1. Repeatedly press the [FUNCTION] button to select the chorus level menu. The LCD displays “Chr Lev”.
Use the [+] / [-] button to adjust the level over the range of 0-32.
2. Pressing [+] and [-] buttons at the same time will reset the chorus level to default.

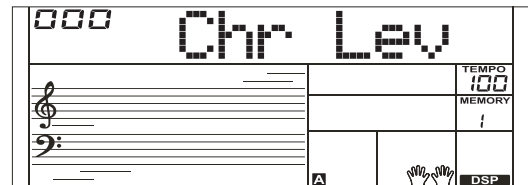

Auto Power Off

1. Repeatedly press the [FUNCTION] button to select the power off menu. The LCD displays “PowerOff”.
Use the [+] / [-] button to change the time setting.
2. Pressing [+] and [-] buttons at the same time will reset the setting to default “015” (15 min).

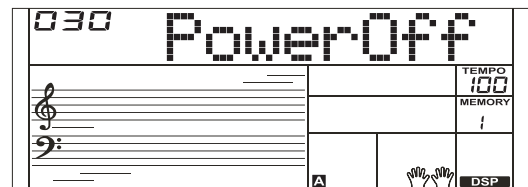

Key Light

Repeatedly press the [FUNCTION] button to select the key light menu. The LCD displays “Key Led”.
Use the [+] / [-] buttons to switch key light on or off.

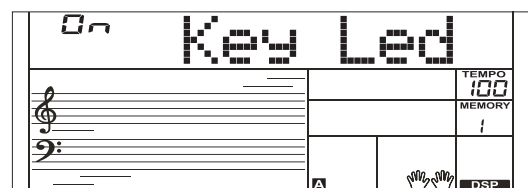

Key Light Channel

Repeatedly press the [FUNCTION] button to select the ChIn Led menu. The LCD displays “ChIn Led”.

Use the [+] / [-] buttons to set the channel that will receive key light message, setting range: all, 1-16.

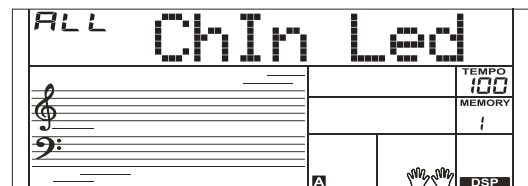

Register Memory

The Registration Memory feature allows you to save virtually all panel settings to a registration memory, and you can instantly recall them by pressing a single button.

The instrument has 8 memory banks, and each bank has 4 memories (M1-M4).

1. Hold down [STORE] button, then press one of the memory buttons [M1] - [M4] to save the panel settings. The LCD will display “Mem Stor” and the new settings will replace the previous memory data.
2. Press one of the memory buttons [M1] - [M4] to recall the panel settings saved to that memory.
3. You can save following parameters to the memory:
Voice Parameter: voice, dual, DSP, mixer.
Accompaniment Parameter: style, tempo, and chord no/off, accompaniment sections.
Function Parameter: touch, some parameters in the function menu.

Note:

Registration memory cannot be recalled when the One Touch Setting function is in use. The registration memory will reset to default settings after power off.

Selecting a Registration Bank

1. Press the [BANK] button. The LCD will display the bank number.
2. Repeatedly press the [BANK] button to select a bank over the range of 1-8.

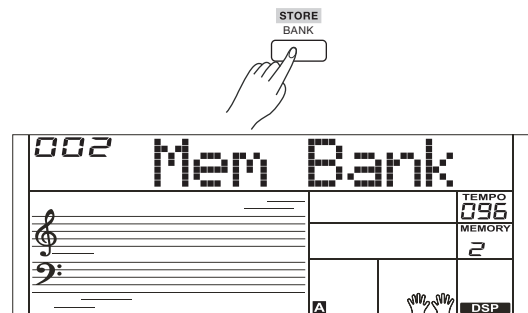
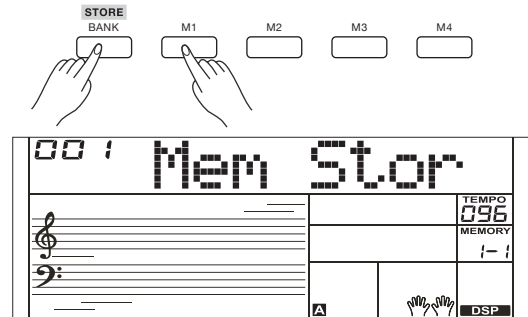

Chord Dictionary

If you know the name of a chord but don't know how to play it, you can use the Chord Dictionary function.

1. Press and hold the [CHORD DICT.] button for 2 seconds to enter this mode. The LCD displays the Chord Type and Chord Notes.
2. The keys above C4 (including C4) are used to assign the Chord Type, and the keys above C6 (including C6) are used to assign the Chord Root. When the Chord Type and Chord Root are confirmed, the LCD will display the Chord and the staff notation.
3. When you play the correct chord on the chord range of the keyboard, an applause sound will be heard.
4. Press and hold the [CHORD DICT.] button for 2 seconds again to exit this mode.

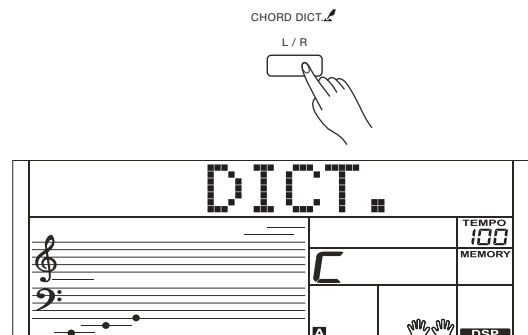

Playing the Songs

The instrument has a variety of songs (Please refer to the Song List). Each song can be practiced in LESSON mode.

Listening to the Songs

1. Press the [SONG] button to enter the song mode. It will play all songs circularly. Press the [SONG] button again, it will stop the song.
2. In song mode, use the number keys and [+]/[-] buttons to select a song.
3. During song playback, you can press the [START/STOP] button to stop the song, press it again to play the current song repeatedly.
4. Use the [TEMPO+]/[TEMPO-] buttons to change the tempo of the current song.
5. When the song is stopped, press [STYLE], [VOICE], [DUAL], [M1] - [M4] to exit the song mode.

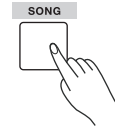

Lesson Mode

The instrument presets 3 different ways to practice a song, as specified in Lesson 1, Lesson 2 and Lesson3. The instrument will grade your practice when you finish a lesson, helping you to keep track of your progress.

1. When song playback is stopped, press the [LESSON] button to enter the lesson mode or select a lesson to practice.
2. Press the [START/STOP] button to start the lesson. The LCD displays the note that needs to be played.
3. Press the [START/STOP] button again to stop the lesson.
4. In lesson mode, press repeatedly the [L/R] button to select to practice the left hand part, the right hand part, or both hands.
5. You can select to practice one of the three lessons. It will grade your practice when you finish a lesson.

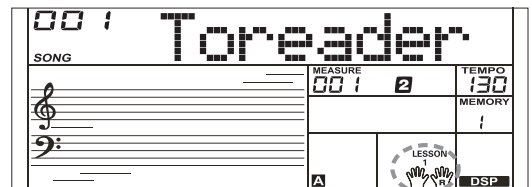
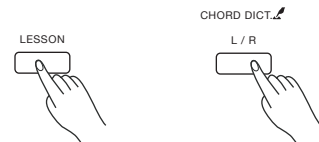

In lesson 1, you will learn to practice at the correct time value. It doesn't matter even you play the wrong notes.

In lesson 2, you will learn to play the correct notes. The lesson will continue only when you have played correctly the note displayed on LCD.

In lesson 3, you will learn to play the correct notes at the correct time value.

When you finish a lesson, the instrument will grade your practice by telling you the level you get.

- Level 1: OK.
- Level 2: Good.
- Level 3: Very Good.
- Level 4: Excellent.

After grading, the song will play back again, and you can practice again.

Recording and Playback

You can record your performance and then play it back.

1. Press the [RECORD] button, the RECORD indicator will be lit, and the beats will flash.
2. Play the keyboard or press the [START/STOP] button to start recording. If you want to record the accompaniment, please turn on the A.B.C. function, then play chords in the chord section of the keyboard.
3. Press the [RECORD] button again to stop recording. The RECORD indicator goes out.
4. Press and hold the [PLAY] button for 2 seconds to play back the recording. The PLAY indicator will be lit.
5. Press and hold the [PLAY] button for 2 seconds again to stop playback. The PLAY indicator goes out.
6. During recording, if you press the [PLAY] button, it will stop recording and play back the notes you have recorded.

Note:

The recording data will be lost after power off.

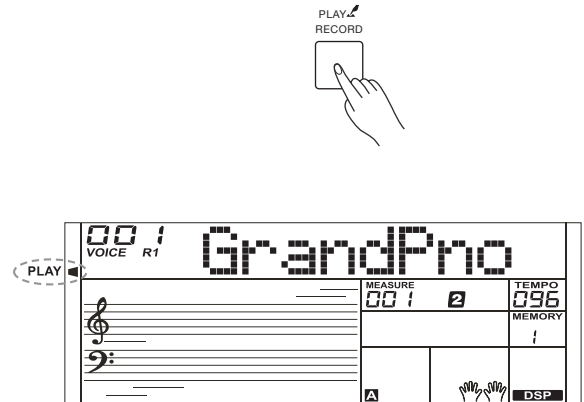
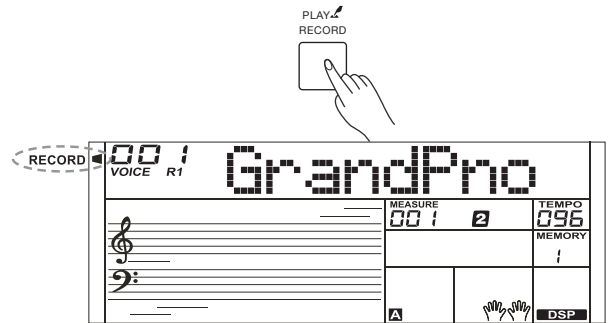

MIDI Function

By using the MIDI functions you can expand your musical possibilities. This section explains what MIDI is, and what it can do, as well as how you can use MIDI on your instrument.

What's MIDI?

MIDI (short for Musical Instrument Digital Interface) allows a wide variety of electronic musical instruments, computers and other related devices to connect and communicate with one another. MIDI carries event messages that specify notation, pitch and velocity, control signals for parameters such as volume, vibrato, audio panning, and program change information to change the voice selections.

The instrument can output the real-time playback information via MIDI and control external MIDI devices. The instrument can also accept incoming MIDI messages and generate sound accordingly.

MIDI Connection

The instrument is equipped with a standard USB interface, which allows the instrument to be connected to a computer. Most computers will automatically recognize the instrument, and allow MIDI messages to be transmitted between the instrument and the computer via the USB-MIDI jack.

Use a standard USB cable to connect the USB jack of the instrument to the USB port of a computer.

Note:

Activate the computer from a sleep/suspended/standby mode before connecting the USB cable.

Connect the USB cable to the instrument and a computer before turning the power of the instrument on.

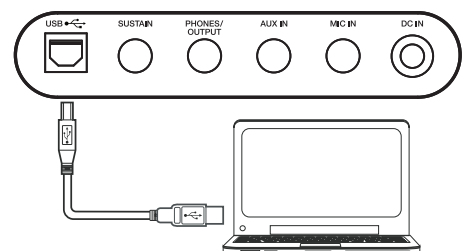

Trouble Shooting

Problem	Possible Cause and Solution
The speakers produce a "pop" sound whenever the power is turned ON or OFF.	This is normal and is no cause for alarm.
No sound results when the keyboard is played.	1. Check if the master volume is set too low. 2. Check if headphones are plugged into the PHONES jack.
When using a mobile phone, noise is produced.	Using a mobile phone in close proximity to the instrument may produce interference. To prevent this, turn off the mobile phone or use it further away from the instrument.
The auto accompaniment does not play back even Sync is in standby condition and a key is pressed.	You may be trying to start accompaniment by playing a key in the right-hand range of the keyboard. To start the accompaniment with Sync Start, make sure to play a key in the left-hand range of the keyboard.

Specifications

Keyboard & Display	
Keyboard	61 Keys with Touch Response
Key Light	Yes
Touch Response	3 types, Off
Display	Multi-functional LCD
Voices	
Polyphony (max.)	64
Voices	580 prest
Layer	Left, Right1, Right2
Split	Yes
Styles	
Styles	200 preset
Style Control	Start / Stop Sync Start Intro / Ending Main A / Fill in A Main B / Fill in B Chord mode Fade in/out Accomp volume
O.T.S.	Yes
Chord Types	32
Effects	
Effects	DSP on / off
Reverb	10 types, 33 levels
Chorus	8 types, 33 levels
Performance Enhance	
Arpeggiator	Arpeggio pattern changes depending on the voice
Song & Recording	
Music Library	155 preset Music tutorial system
Sequencer	1 user song
Demo Song	155

Pitch Adjustment	
Transpose	-12 ~ +12
Octave	-2 ~ +2
Tuning	-50 ~ +50
Other Functions	
Mixer	Yes (8 tracks)
Performance Memory	8 preset banks x 4
Modulation	Yes
Metronome	0, 2 ~ 9
Tempo	5 ~ 280
Other control	Piano Mode, Chord Dict
Connections	
Interaction & Expansion	USB MIDI
Phones	1 standard stereo
Pedals	Sustain
USB	USB MIDI
Input	Standard stereo
Output	Yes (Phones jack)
Power Supply	
Power	DC 12V / 1 A
Power Off Protection	Yes
Amplifiers & Speakers	
Amplifiers	2.5W x 2
Speakers	3W x 2
Dimensions & Weight	
Dimensions LWH (mm)	946 x 316 x 101
Weight (kg)	4

* All specifications and appearances are subject to change without notice.

Voice List

No.	English Name	LCD Name
PIANO		
1	Acoustic Grand Piano	GrandPno
2	Piano Dark	GrdPnD
3	Piano Dark 2	GrdPnD2
4	Octave Piano	OctPno
5	Octave Piano 2	OctPno2
6	Piano & Choir	Pno&Cho
7	Grand Piano / W	GrandPnW
8	Analog E.Piano	AnEPno
9	Analog E.Piano 2	AnEPno2
10	Analog E.Piano Wah	AnPnoWah
11	Bright Piano	BritPno
12	Bright Piano 2	BritPno2
13	Stereo Bright Piano	BritePnS
14	Detuned Piano	DetunPno
15	Chorus Piano	ChoPno
16	Chorus Piano 2	ChoPno2
17	Bright Piano / W	BritPnW
18	Bright Piano 2 / W	BritPnW2
19	Piano & Vibraphone	Pno&Vib
20	Electric Grand Piano	EPianoG
21	Electric Grand Piano / W	E.PianoW
22	Stereo Synth E.Piano	StSyEIPn
23	Stereo Synth E.Piano 2	StSyEPn2
24	Honky-Tonk Piano	HnkyTonk
25	Honky-Tonk Dark	HnkTonkD
26	Honky-Tonk / W	HnkyTkW
27	Honky-Tonk 2 / W	HnkyTkW2
28	E.Piano	E.Piano
29	Stereo E.Piano	EPianoS
30	50's E.Piano	50'sEP
31	E.Piano / W	EPianoW
32	E.Piano 2 / W	EPianoW2
33	E.Piano 3 / W	EPianoW3
34	E.Piano 4 / W	EPianoW4
35	E.Piano 2	E.Piano2
36	E.Piano 3	E.Piano3
37	Detuned E.P.	DetunEP
38	Detuned E.P. 2	DetunEP2
39	Harpsichord	Harpsi
40	Harpsichord / W	HarpsiW
41	Harpsichord 2 / W	HarpsiW2
42	Harpsichord Octave	HarpsiO
43	Harpsichord Octave 2	HarpsiO2
44	Harpsichord Off	HarpsiOf
45	Digital E.Piano	DigiEP
46	Digital E.Piano 2	DigiEP2
47	Clavichord	Clavi
48	Clavichord 2	Clavi2
49	Stereo Clavichord	ClaviS
50	Clavichord / W	ClaviW
51	Clavichord Wah	ClaviWa
52	Synth Clav	SynClav
CHROMATIC PERCUSSION		
53	Celesta	Celesta

54	Celesta 2	Celesta2
55	Dark Celesta	CelestD
56	Dark Celesta 2	CelestD2
57	Celesta & Sine	Cele&Sin
58	Reecho Bell	ReBell
59	Reecho Bell 2	ReBell2
60	Celesta & Music Box	Cel&Mbox
61	Glockenspiel	Glocken
62	Glockenspiel & Sine	Glkn&Sin
63	Children's Song	ChilSong
64	Analog Bell	AnaBell
65	Stereo Analog Bell	StAnaBel
66	Music Box	MusicBox
67	Vibraphone	Vibra
68	Vibraphone / W	VibraW
69	Vibraphone & Bell	Vibr&Bel
70	Vibraphone & Harpsichord	Vibr&Hrp
71	Marimba	Marimba
72	Marimba 2	Marimba2
73	Marimba / W	MarimbaW
74	Marimba 2 / W	MarimbW2
75	Sine Marimba	Marm&Sin
76	Stereo Marimba	MarimbaS
77	Marimba & Vibraphone	Marm&Vib
78	Wood Drum	WoodDrum
79	Rotating	Rotating
80	Dual Attack	DualAtta
81	Stereo TRI	StTRI
82	Xylophone	Xylophon
83	Xylophone 2	Xylphon2
84	Tubular Bells	TubuBel
85	Tubular Bells 2	TubuBel2
86	Tubular Bells 3	TubuBel3
87	Rotate Octave	RotateOc
88	Synth Organ Staccato	SyOrSta
89	Synth Organ Staccato 2	SyOrSta2
90	Dulcimer	Dulcimer
91	Dulcimer 2	Dulcimr2
ORGAN		
92	Drawbar Organ	DrawOrg
93	Stereo Drawbar Organ	DrawOrgS
94	Soft Stereo Drawbar Organ	DrawOgSf
95	Mellow Drawbar Organ	MellOrg
96	Bright Drawbar Organ	DrawOrgB
97	Percussive Organ	PercOrgn
98	Percussive Organ Detuned	DePerOrg
99	Rock Organ	RockOrgn
100	Rock Organ 2	RokOrgn2
101	Church Organ	ChurOrgn
102	Detuned Church Organ	DeChuOrg
103	Octave Church Organ	ChrOrgO
104	Octave Church Organ 2	ChrOrgO2
105	Finale	Finale
106	Finale 2	Finale2
107	Digital Organ	DigiOrg
108	Analog Organ	AnaOrg

Voice List

109	Analog Organ 2	AnaOrg2
110	Reed Organ	ReedOrgn
111	Reed Organ 2	RedOrgn2
112	Stereo Reed Organ	ReedOrgS
113	Accordion	Acordin
114	Accordion 2	Acordin2
115	Stereo Accordion	AcordinS
116	Harmonica	Harmnica
117	Dark Harmonica	HarmnicD
118	Tango Accordion	TangoAcid
119	Dark Tango Accordion	TangoAcidD
GUITAR		
120	Nylon Guitar	NylonGtr
121	Chorus Nylon Guitar	NylonGtC
122	Stereo Nylon Guitar	NylonGtS
123	Stereo Nylon Guitar 2	NylnGtS2
124	Steel Guitar	SteelGtr
125	12 String Guitar	12StrGtr
126	Detuned Steel Guitar	DetStlGt
127	Jazz. Guitar	JazzGtr
128	Clean Guitar	CleanGtr
129	Clean Guitar 2	CleanGt2
130	Stereo Clean Guitar	CleanGtS
131	Soft Clean Guitar	ClnGtSof
132	Chord Clean Guitar	ClnGtCho
133	Muted Guitar	MutedGtr
134	Muted Guitar 2	MutedGt2
135	Stereo Muted Guitar	MutedGtS
136	Chord Muted Guitar	MutGtCho
137	Overdrive Guitar	Ovrdrive
138	Dance Lead	DancLead
139	Distortion Guitar	DistGtr
140	Analog Distortion Guitar	AnDistGt
141	5Th Distortion	5ThDist
142	5Th Distortion 2	5ThDist2
143	Analog Distortion	AnaDist
144	Analog Distortion 2	AnaDist2
145	Analog Distortion Wah	AnDisWah
146	Analog Distortion Wah 2	AnDisWa2
147	Guitar Harmonics	GtrHarmo
STRINGS & ORCHESTRAL		
148	Acoustic Bass	AcoBass
149	Acoustic Bass 2	AcoBass2
150	Acoustic Bass Detuned	DetAcoBs
151	Velocity Crossfade Bass	VelCroBs
152	Jazz Style	JazzSty
153	A.Bass & Mute G.T.	ABs&MtGT
154	Finger Bass	FngrBs
155	Finger Bass 2	FngrBs2
156	Finger Bass 3	FngrBs3
157	Dark Finger Bass	FngrBsD
158	Detuned Finger Bass	DetFngBs
159	Velocity Bass	VelBass
160	Bass & Distortion Guitar	Bs&DisGt
161	Pick Bass	PickBs

162	Pick Bass 2	PickBs2
163	Pick Bass 3	PickBs3
164	Mute Pick Bass	PickBsM
165	Pick & Finger Bass	Pk&FgBs
166	Pick Bass & Clean Guitar	PBs&ClGt
167	Detuned Pick Bass	DetPkBs
168	Fretless Bass	Fretles
169	Fretless Bass 2	Fretles2
170	Fretless Bass 3	Fretles3
171	Slap Bass	SlapBas
172	Slap Bass 2	SlapBas2
173	Slap Bass 3	SlapBas3
174	Slap Bass 4	SlapBas4
175	Slap Bass 5	SlapBas5
176	Synth Bass	SynBass
177	Synth Bass 2	SynBass2
178	Synth Bass 3	SynBass3
179	Synth Bass 4	SynBass4
180	Synth Bass 5	SynBass5
STRINGS & ORCHESTRAL		
181	Violin	Violin
182	Violin 2	Violin2
183	2 Violin	2Violin
184	Viola	Viola
185	Viola 2	Viola2
186	2 Viola	2Viola
187	Cello	Cello
188	Cello 2	Cello2
189	2 Cello	2Cello
190	Contrabass	Contrbs
191	Contrabass 2	Contrbs2
192	Tremolo Strings	TremStr
193	Tremolo Strings 2	TremStr2
194	Tremolo Strings 3	TremStr3
195	Pizzicato Strings	PizzStr
196	Pizzicato Strings 2	PizzStr2
197	Pizzicato Strings 3	PizzStr3
198	Orchestral Harp	Harp
199	Orchestral Harp 2	Harp2
200	Orchestral Harp 3	Harp3
201	Stereo Harp	HarpS
202	Timpani	Timpani
203	Timpani 2	Timpani2
204	Timpani 3	Timpani3
205	Strings Ensemble	Strings
206	Strings Ensemble 2	Strings2
207	Strings Ensemble 3	Strings3
208	Boiling Life	Boiling
209	Stereo Strings	StringS
210	Stereo Strings 2	StringS2
211	Synth Strings	SynStrs
212	Synth Strings 2	SynStrs2
213	Synth Strings 3	SynStrs3
214	Stereo Synth Strings	SynStrS
215	Stereo Synth Strings 2	SynStrS2

216	Analog Orchestra	AnaOrch
217	Analog String	AnaStr
218	Analog String 2	AnaStr2
219	Slow Strings	SlowStr
220	Slow Strings 2	SlowStr2
221	Choir Aahs	ChoirAah
222	Choir Aahs 2	ChoirAh2
223	Dark Aahs	ChoAhD
224	Dark Aahs 2	ChoAhD2
225	Stereo Aahs	ChoAhS
226	Stereo Aahs 2	ChoAhS2
227	Mellow Choir Aahs	ChoAhMel
228	Aahs & SynStr	Ah&SyStr
229	Big Aahs	BigAahs
230	Analog Sound	AnaSound
231	Analog Sound 2	AnSound2
232	Analog Sound 3	AnSound3
233	Voice Ooh	VoiceOoh
234	Synth Voice	SynVoic
235	Synth Voice 2	SynVoic2
236	Stereo Synth Voice	SynVoicS
237	HK 80's	HK80's
238	Homesick	Homesick
239	Child Interest	Interest
240	Child Interest 2	Intrest2
241	Mechanical Voice	MechanVo
242	Power Voice	PoweVo
243	Child Interest Wah	InterWah
244	Orchestra Hit	OrchHit
245	Orchestra Hit Stereo	OrchHitS
246	Orchestra Hit Octave	HitOctO
BRASS		
247	Trumpet	Trumpet
248	Trumpet 2	Trumpet2
249	Dark Trumpet	TrumpetD
250	Dark Trumpet 2	TrmpetD2
251	Wah Trumpet	TrumpetW
252	Trombone	Trmbone
253	Trombone 2	Trmbone2
254	Tuba	Tuba
255	Tuba 2	Tuba2
256	Muted Trumpet	MuteTrp
257	Muted Trumpet 2	MuteTrp2
258	Horn	Horn
259	Horn 2	Horn2
260	Horn 3	Horn3
261	Stereo Synth Brass	StSyBras
262	5th Horn	5thHorn
263	Brass Ensemble	Brass
264	Majestic Unison	Unison
265	Synth Brass	SynBras
266	Synth Brass 2	SynBras2
267	Synth Brass 3	SynBras3
268	Synth Brass 4	SynBras4
269	Synth Brass 5	SynBras5
270	Sharp Brass	SharpBra

271	Analog Brass	AnaBrass
272	Analog Brass 2	AnaBras2
273	Dynamics Analog Brass	DyAnaBra
274	Octave Synth Brass	SynBrasO
REED		
275	Soprano Sax	SprnSax
276	Soprano Sax 2	SprnSax2
277	Alto Sax	AltoSax
278	Alto Sax 2	AltoSax2
279	Tenor sax	TenoSax
280	Tenor sax 2	TenoSax2
281	Baritone Sax	BariSax
282	Baritone Sax 2	BariSax2
283	Oboe	Oboe
284	Oboe 2	Oboe2
285	Sweet Oboe	SwetOboe
286	English Horn	EngHorn
287	English Horn 2	EngHorn2
288	Bassoon	Bassoon
289	Bassoon 2	Bassoon2
290	Clarinet	Clarine
291	Clarinet 2	Clarine2
PIPE		
292	Piccolo	Piccolo
293	Piccolo 2	Piccolo2
294	Flute	Flute
295	Flute 2	Flute2
296	Recorder	Recordr
297	Recorder 2	Recordr2
298	Pan Flute	PanFlut
299	Pan Flute 2	PanFlut2
300	Blown Bottle	Bottle
301	Blown Bottle 2	Bottle2
302	Shakuhachi	Shakchi
303	Shakuhachi 2	Shakchi2
304	Whistle	Whistle
305	Whistle 2	Whistle2
306	Ocarina	Ocarina
307	Ocarina 2	Ocarina2
SYNTH LEAD		
308	Square Lead	SquarLd
309	Square Lead 2	SquarLd2
310	Square Lead 3	SquarLd3
311	Analog Lead	AnaLead
312	Lead Sine	SineLead
313	Lead Sine 2	SinLead2
314	Analog Electric	AnaElect
315	Slow Square Lead	SlowLead
316	Analog Classic Lead	AnClasLd
317	Thick Square	ThickSq
318	Quint	Quint
319	Sine Solo	SineSolo
320	Pulse Lead	PulseLd
321	Pulse Lead 2	PulseLd2
322	Mellow Wind	Wind
323	80's Digital	80'sDig

Voice List

324	Classic TRI	ClassTRI
325	Stereo Analog Wind	StAnWind
326	Stereo Analog Wind 2	StAnWid2
327	Sawtooth Lead	SawLead
328	Sawtooth Lead 2	SawLead2
329	Sawtooth Lead 3	SawLead3
330	Stereo Sawtooth	SawLdS
331	Stereo Sawtooth 2	SawLdS2
332	Stereo Sawtooth 3	SawLdS3
333	Electronic Lead	ElecLead
334	Psychedelic	Psyched
335	80's Synth	80'sSyn
336	5Th Analog	5ThAna
337	5Th Analog 2	5ThAna2
338	Vitality	Vitality
339	5th Sawtooth	5thSaw
340	5th Sawtooth 2	5thSaw2
341	Comedy	Comedy
342	Comedy 2	Comedy2
343	Fazli Lead	FazliLd
344	80's Sawtooth	80'sSaw
345	Wind Chimes	WindChi
346	5Th Digital Age	5ThDigAg
347	5Th Digital Age 2	5ThDgAg2
348	5Th Square	5ThSqu
349	5Th Square 2	5ThSqu2
350	Stereo Pulse	StPulse
351	Stereo Pulse 2	StPulse2
352	Analog Signal	AnSignal
353	Analog Signal 2	AnSignl2
354	Stereo Electronic Lead	StElecLd
355	Stereo Electronic Lead 2	StEleLd2
356	Stereo Electronic Lead 3	StEleLd3
357	Stereo Electronic Lead 4	StEleLd4
358	Calliope Lead	CalipLd
359	Calliope Lead 2	CalipLd2
360	Calliope Lead 3	CalipLd3
361	Grand	Grand
362	Grand 2	Grand2
363	Octave Pad	OctPad
364	Classic Lead	ClassLD
365	Sawtooth Wah	SawWah
366	Chiff Lead	ChiffLd
367	Chiff Lead 2	ChiffLd2
368	Chiff Lead 3	ChiffLd3
369	Charang Lead	CharnLd
370	Charang Lead 2	CharnLd2
371	Fruity Lead	FruityLd
372	Fruity Lead 2	FruityLd2
373	Voice Lead	VoiceLd
374	Voice Lead 2	VoiceLd2
375	Robot	Robot
376	Robot 2	Robot2
377	Modulation Distortion	ModDist
378	Modulation Distortion 2	ModDist2

379	Control	Control
380	Vague Vocals	VagueVo
381	Singl Synth	SinglSyn
382	Analog Filter	AnaFilt
383	Analog Voice	AnaVo
384	Analog Voice 2	AnaVo2
385	Fifths Lead	FifthsLd
386	Ninja	Ninja
387	Ninja 2	Ninja2
388	Bass & Lead	Bs&Lead
389	Bass & Lead 2	Bs&Lead2
390	Bass & Lead 3	Bs&Lead3
391	Classic Synth	ClassSyn
392	Classic Synth 2	ClassSy2
393	Classic Synth 3	ClassSy3
394	Electron Impac	EleImpac
395	Elastic Across	Across
396	Single Sawtooth	SinglSaw
397	Analog Wind	AnaWind
398	Electron Saw	EleSaw
399	Boring Sine	BorSine
400	Steel Wire	SteelWir
401	Steel Wire 2	SteelWr2
402	Analog Pulse	AnaPulse
403	Happiness	Happines
404	Happiness 2	Happine2
405	Happiness 3	Happine3
406	Deformation Pulse	DefPulse
SYNTH PAD		
407	New Age Pad	NewAgPd
408	New Age Pad 2	NewAgPd2
409	New Age Pad 3	NewAgPd3
410	Rise	Rise
411	Praise	Praise
412	Intangible	Intangi
413	Warm Day	WarmDay
414	Warm Day 2	WarmDay2
415	Warm Day 3	WarmDay3
416	Dunhuang	Dunhuang
417	Free Space	FreeSpa
418	Plump Sawtooth	PlumpSaw
419	Square Wah	SquaWah
420	Double Pulse	DoubPul
421	Comedy Wah	ComeWah
422	Phase Shift	PhaShift
423	Phase Shift 2	PhaShit2
424	Warm Pad	WarmPad
425	Warm Pad 2	WarmPad2
426	Overture	Overture
427	Verve	Verve
428	Fulness Pad	FulnesPd
429	Overture Wah	OvertWah
430	Digital Age	DigitAge
431	Analog Pad	AnalPd
432	Analog Pda2	AnalPd2
433	Analog Pad 3	AnalPd3

Voice List

434	Analog Pad 4	AnalPd4
435	Analog Pad 5	AnalPd5
436	Analog Wah	AnaloWah
437	Sharp	Sharp
438	Warm Pulse	WarmPul
439	Warm Pulse 2	WarmPul2
440	Happiness Pad	HappiPd
441	Sawtooth Pad	SawPad
442	Sawtooth Pad 2	SawPad2
443	Poly Synth Pad	PlySyPd
444	Poly Synth Pad 2	PlySyPd2
445	Poly Synth Pad 3	PlySyPd3
446	Modulation Distortion Wah	ModDiWah
447	Choir Pad	ChoPad
448	Choir Pad 2	ChoPad2
449	Plush Pad	PlushPad
450	Dawn Wah	DawnWah
451	Chorus Pad Wah	ChoPdWah
452	Electric Pad	ElecPad
453	5Th PAD	5ThPad
454	Bowed Pad	BowdPad
455	Bowed Pad 2	BowdPad2
456	Bowed Pad 3	BowdPad3
457	Metallic Pad	MetalPad
458	Dream	Dream
459	Dream 2	Dream2
460	Dream 3	Dream3
461	Dpray	Dpray
462	Digital Pad	DigiPad
463	Organ Pad Wah	OrganWah
464	Pipe Organ Pad	PipOrPd
465	Scene Pad	ScenePad
466	Halo Pad	HaloPad
467	Halo Pad 2	HaloPad2
468	Background	Backgrd
469	Background 2	Backgrd2
470	Background 3	Backgrd3
471	Background 4	Backgrd4
472	Sweep Pad	SweepPad
473	Star Trek	StarTrek
474	Digital Wah	DigiWah
475	Warm Wah	WarmWah
476	Pulse Wah	PulseWah
477	Digital Distortion Wah	DiDisWah
478	Pulse	Pulse
479	Pulse 2	Pulse2
480	Pulse 3	Pulse3
SYNTH SFX		
481	Rain	Rain
482	Mysterious	Mysterio
483	Clusters of Stars	Stars
484	Additive Synthesis	AddSynth
485	Want To Go	Wanttogo
486	Additive Synth Wah	AddWah

487	Soundtrack	Soundtrk
488	Lost Garden	Garden
489	Far Away	FarAway
490	Crystal	Crystal
491	Crystal 2	Crystal2
492	Crystal 3	Crystal3
493	Drops Of Water	Water
494	Game	Game
495	Game 2	Game2
496	Fly Into Space	Fly
497	Little Funny	Funny
498	Funny Hammer	FunnyHam
499	Surface Of The Water	Surface
500	Water Drop	WaterWah
501	Atmosphere	Atmosphr
502	Clouds	Clouds
503	Clouds 2	Clouds2
504	Brightness	Bright
505	Brightness 2	Bright2
506	Life	Life
507	Life 2	Life2
508	Fresh	Fresh
509	Fresh 2	Fresh2
510	Goblins	Goblins
511	Fantasy	Fantasy
512	Space Trojan	SpaceTro
513	Ceremony	Ceremony
514	Phonism	Phonism
515	Phonism 2	Phonism2
516	Echoes	Echoes
517	Echoes 2	Echoes2
518	Empty	Empty
519	Empty 2	Empty2
520	Deformation	Deformat
521	Deformation 2	Deforma2
522	Sci-Fi	Sci-Fi
523	Sci-Fi 2	Sci-Fi2
524	WindBells	WindBell
525	WindBells 2	WindBel2
526	Artistic	Artistic
527	Artistic 2	Artisti2
528	Artistic 3	Artisti3
529	Artistic 4	Artisti4
530	Artistic 5	Artisti5
531	Digital Effect	DigitaEf
532	Abyss	Abyss
533	Abyss 2	Abyss2
534	Abyss 3	Abyss3
535	Spectrum	Spectrum
536	Spectrum 2	Spectru2
537	Spectrum 3	Spectru3
ETHNIC MISC.		
538	Sitar	Sitar
539	Sitar 2	Sitar2

540	Detuned Sitar	DetSitar
541	Banjo	Banjo
542	Banjo 2	Banjo2
543	Shamisen	Shamisen
544	Shamisen 2	Shamisen2
545	Shamisen 3	Shamisen3
546	Koto	Koto
547	Koto 2	Koto2
548	Koto 3	Koto3
549	Kalimba	Kalimba
550	Kalimba 2	Kalimba2
551	Kalimba 3	Kalimba3
552	Bagpipe	Bagpipe
553	Bagpipe 2	Bagpipe2
554	Fiddle	Fiddle
555	Fiddle 2	Fiddle2
556	Shania	Shania
557	Shania 2	Shania2
PERCUSSIVE		
558	Tinkle Bell	TnklBell
559	Agogo	Agogo
560	Steel Drums	StelDrum
561	Bass Drum	BassDrum
562	Wood Block	WoodBlok
563	Snare	Snare
564	Taiko Drum	TaikoDrm
565	Melodic Tom	MelodTom
566	Synth Drum	SynDrum
567	Dynamics jump	Dynjump
568	Reverse Cymbal	RevCymbI
SFX		
569	Guitar Fret Noise	FretNoiz
570	Breath Noise	BrthNoiz
571	Seashore	Seashore
572	Bird Tweet	Tweet
573	Telephone Ring	Telephone
574	Helicopter	Helicptr
575	Applause	Applause
576	Gunshot	Gunshot
577	Fall	Fall
SYNTH SFX		
578	Standard Drum Set	StandSet
579	Rock Drum Set	RockSet
580	Electronic Drum Set	ElecSet

Style List

No.	English Name	LCD Name
LATIN 1		
1	Cha Cha	ChaCha
2	Pop Cha Cha	P.ChaCha
3	Rhumba	Rhumba
4	Pop Rhumba	P.Rhumba
5	Bossa Nova 1	Bossa1
6	Bossa Nova 2	Bossa2
7	Tango	Tango
8	Jazz Samba	JazSamba
9	Reggae	Reggae
10	Pop Reggae	P.Reggae
DANCE 1		
11	Disco 1	Disco1
12	Disco 2	Disco2
13	Disco Funk	DiscFunk
14	Dance	Dance
15	House 1	House1
16	House 2	House2
17	Rap	Rap
18	Euro Beat	EuroBeat
19	Hip Hop	HipHop
20	Techno	Techno
BEAT & POP 1		
21	8 Beat 1	8Beat1
22	8 Beat 2	8Beat2
23	8 Beat 3	8Beat3
24	8 Beat 4	8Beat4
25	60's 8 Beat	60's8Bt
26	8 Beat Ballad	8BtBld
27	8 Beat Rock	8BtRock
28	16 Beat 1	16Beat1
29	16 Beat 2	16Beat2
30	16 Beat Pop	16BtPop
31	16 Beat Shuffle	16BtShfl
32	Ballad	Ballad
33	Slow Ballad	SlowBld
34	16 Beat Ballad	16BtBld
35	Unplugged	Unplugged
ROCK 1		
36	Rock	Rock
37	Pop Rock	PopRock
38	Fast Rock	FastRock
39	Slow Rock 1	SlwRock1
40	Slow Rock 2	SlwRock2
41	Rock & Roll	RockRoll
42	Heavy Metal	H.Metal
43	Blues Boogie	B.Boogie
44	Blues	Blues
45	Shuffle	Shuffle
46	Blues Shuffle	B.Shufle
47	Rock Shuffle	R.Shufle
48	Charleston	Charston
SOUL & FUNK 1		
49	Funky Pop	FunkyPop
50	Jazz Funk	JazzFunk

51	Cool Funky	CoolFunk
52	Soul 1	Soul1
53	Soul 2	Soul2
54	Soul Shuffle	SoulShfl
55	Soul Blues	SoulBlue
56	R & B	R&B
57	6/8 Gospel	6/8Gospl
58	Pop Groove	PopGrove
JAZZ 1		
59	Swing	Swing
60	Cool Jazz	CoolJazz
61	Pop Swing	PopSwing
62	Swing Fox	SwingFox
63	Big Band	BigBand
64	Big Band Medium	BandMedi
65	Jazz Waltz	JazWaltz
66	Ragtime	Ragtime
67	Dixieland	Dixeland
68	Quick Step	QuickStp
COUNTRY 1		
69	Country 1	Country1
70	Country 2	Country2
71	Pop Country	PopCntry
72	Country Rock	CtryRock
73	Country Folk	CtryFolk
74	3/4 Country	3/4Ctry
75	Country Waltz	C.Waltz
76	Country Shuffle	CtryShfl
77	Country Boogie	C.Boogie
78	Country Blues	C.Blues
79	Country Quick Step	CtryStep
80	Bluegrass	Bluegras
TRADITIONAL 1		
81	March 1	March1
82	March 2	March2
83	German March	G.March
84	6/8 March	6/8March
85	Polka	Polka
86	Pop Polka	PopPolka
87	Waltz	Waltz
88	Slow Waltz	SloWaltz
89	Vienna Waltz	VieWaltz
90	Musette	Musette
PIANIST 1		
91	Piano 8 Beat	Pno8Beat
92	Piano Ballad	PnoBalad
93	Piano Boogie	PnoBogie
94	Piano Jazz	PnoJazz
95	Piano Swing	PnoSwing
96	Piano Jazz Waltz	P.JWaltz
97	Piano Twist	PnoTwist
98	Piano March	PnoMarch
99	Piano 6/8 March	Pno6/8Mr
100	Piano Waltz	PnoWaltz
LATIN 2		
101	Cha Cha-2	ChaCha2
102	Pop Cha Cha-2	P.ChaCa2
103	Rhumba-2	Rhumba2
104	Pop Rhumba-2	P.Rhumb2
105	Bossa Nova 1-2	Bossa1-2

106	Bossa Nova 2-2	Bossa2-2
107	Tango-2	Tango-2
108	Jazz Samba-2	JzSamba2
109	Reggae-2	Reggae2
110	Pop Reggae-2	P.Regga2
DANCE 2		
111	Disco 1-2	Disco1-2
112	Disco 2	Disco2-2
113	Disco Funk-2	DiscoFk2
114	Dance-2	Dance-2
115	House 1-2	House1-2
116	House 2-2	House2-2
117	Rap-2	Rap-2
118	Euro Beat-2	EuropBt2
119	Hip Hop-2	HipHop-2
120	Techno-2	Techno-2
BEAT & POP 2		
121	8 Beat 1-2	8Beat1-2
122	8 Beat 2-2	8Beat2-2
123	8 Beat 3-2	8Beat3-2
124	8 Beat 4-2	8Beat4-2
125	60's 8 Beat-2	60's8Bt2
126	8 Beat Ballad-2	8BtBld-2
127	8 Beat Rock-2	8BtRck-2
128	16 Beat 1-2	16Bt1-2
129	16 Beat 2-2	16Bt2-2
130	16 Beat Pop-2	16BtPop2
131	16 Beat Shuffle-2	16BtShf2
132	Ballad-2	Ballad-2
133	Slow Ballad-2	SlwBld-2
134	16 Beat Ballad-2	16BtBld2
135	Unplugged-2	Unplug-2
ROCK 2		
136	Rock-2	Rock-2
137	Pop Rock-2	PopRck-2
138	Fast Rock-2	FastRk-2
139	Slow Rock 1-2	SlwRk1-2
140	Slow Rock 2-2	SlwRk2-2
141	Rock & Roll-2	RkRoll-2
142	Heavy Metal-2	H.Metal2
143	Blues Boogie-2	B.Bogie2
144	Blues-2	Blues-2
145	Shuffle-2	Shuffle-2
146	Blues Shuffle-2	B.Shuffl2
147	Rock Shuffle-2	R.Shuffl2
148	Charleston-2	Charstn2
SOUL & FUNK 2		
149	Funky Pop-2	FunkPop2
150	Jazz Funk-2	JazzFk-2
151	Cool Funky-2	CoolFk-2
152	Soul 1-2	Soul1-2
153	Soul 2-2	Soul2-2
154	Soul Shuffle-2	SoulShf2
155	Soul Blues-2	SoulBlu2
156	R & B-2	R&B-2
157	6/8 Gospel-2	6/8Gosp2
158	Pop Groove-2	PopGrov2
JAZZ 2		
159	Swing-2	Swing-2
160	Cool Jazz-2	CoolJz-2
161	Pop Swing-2	PopSwin2

162	Swing Fox-2	SwinFox2
163	Big Band-2	BigBand2
164	Big Band Medium-2	BandMed2
165	Jazz Waltz-2	JzWaltz2
166	Ragtime-2	Ragtime2
167	Dixieland-2	Dixland2
168	Quick Step-2	QuickSp2
COUNTRY 2		
169	Country 1-2	Cntry1 -2
170	Country 2-2	Cntry2 -2
171	Pop Country-2	PopCtry2
172	Country Rock-2	CtryRk -2
173	Country Folk-2	CtryFok2
174	3/4 Country -2	3/4Ctry2
175	Country Waltz-2	C.Waltz2
176	Country Shuffle-2	CtryShf2
177	Country Boogie-2	C.Bogie2
178	Country Blues-2	C.Blues2
179	Country Quick Step-2	CtryStp2
180	Bluegrass-2	Bluegra2
TRADITIONAL 2		
181	March 1-2	March1 -2
182	March 2-2	March2 -2
183	German March-2	G.March2
184	6/8 March-2	6/8Marc2
185	Polka-2	Polka -2
186	Pop Polka-2	PopPoka2
187	Waltz-2	Waltz -2
188	Slow Waltz-2	SlWaltz2
189	Vienna Waltz-2	ViWaltz2
190	Musette-2	Musette2
PIANIST 2		
191	Piano 8 Beat-2	Pno8Bt -2
192	Piano Ballad-2	PnoBald2
193	Piano Boogie-2	PnoBogi2
194	Piano Jazz-2	PnoJazz2
195	Piano Swing-2	PnoSwin2
196	Piano Jazz Waltz-2	P.JWalz2
197	Piano Twist-2	PnoTwis2
198	Piano March-2	PnoMarc2
199	Piano 6/8 March-2	Pno6/8M2
200	Piano Waltz-2	P.Waltz2

Song List

No.	English Name	LCD Name
CLASSIC		
1	Chanson Du Toreador	Toreador
2	Meditation	Meditati
3	Wiegenlied	WieGenli
4	A Lover's Concerto	Concerto
5	Whispering Hope	Whisper
6	From The New World	NewWorld
7	O Sole Mio	OSoleMio
8	Auf Flugeln Des Gesanges	Gesanges
9	Santa Lucia	SantaLuc
FAVORITE		
10	Deck The Halls	DeckHall
11	Old Folks At Home	OldFolks
12	Camptown Races	C.Races
13	Oh! Susanna	Susanna
14	Jeanie With The Light Brown Hair	Jeanie
15	Long Long Ago	LongAgo
16	Annie Laurie	AnnieLa
17	My Old Kentucky Home	Kentucky
18	Turkey In The Straw	TukyStaw
19	Aloha Oe	AlohaOe
20	Carry Me Back To Old Virginny	Virginny
21	The Blue-Bells Of Scotland	BlueBell
22	Joy To The World	JoyWorld
23	Jingle Bells	JingBell
24	Battle Hymne Of The Republic	BatlHyme
25	Silent Night	SltNight
26	Ode To Joy	OdeToJoy
27	My Bonnie	MyBonnie
28	La Cucaracha	Cucarach
29	Yellow Rose Of Texas	YellRose
30	The Wabash Cannon Ball	CannBall
31	Red River Valley	RedRiver
32	Dreaming Of Home And Mother	Dreaming
33	Ring Ring De Banjo	DeBanjo
34	Der Freischutz	DerFreis
35	Tales Of Hoffman	Hoffman
36	Die Forelle	Forelle
FOLK		
37	Aura Lea	AuraLea
38	When The Saints Go Marching In	Marching
39	Twinkle Twinkle Little Star	Twinkle
40	I've Been Working On The Railroad	WorkRail
41	With Games	WithGame
42	Way Home	WayHome
43	Yankee Doodle	YankeeD
44	Michael Row The Boat Ashore	RowBoat
45	Auld Lang Syne	LangSyne
46	My Darling Clementine	Clemtine
47	Little Brown Jug	BrownJug
48	The House Of The Rising Sun	RiseSun
49	Danny Boy	DannyBoy
50	El Condor Pasa	ElCondor
51	Greensleeves	Sleeves
52	Heidenroslein	Heidenro

53	Wiegenlied 2	WiegliD2
54	Her Bright Smile Haunts Me Still	HerSmile
55	Old Black Joe	BlackJoe
56	Old Dog Tray	DogTray
57	Are You Lonesome Tonight?	Lonesome
58	Arirang	Arirang
59	The Quilting Party	TheParty
60	The Colorado Trail	TheTrail
61	I'D Like To Be In Texas	InTexas
62	Shenandoah	Shenando
63	Down In The Valley	Valley
64	On Top Of Old Smoky	TopSmoky
65	Barbara Allen	Allen
66	Careless Love	CaleLove
67	Sweet Betsy From Pike	SwetPike
68	Jesse James	James
69	The Cowboy's Lament	CowboyLa
KID'S SONG		
70	Skip To My Lou	SkipMyLo
71	London Bridge Is Falling Down	Bridge
72	Home On The Range	HomeRang
73	This Old Man	OldMan
74	Polly Wolly Doodle	PlyWlyDo
75	Sippin' Cider Through A Straw	SipinCid
76	Home Sweet Home	SwetHome
77	Mary Had A Little Lamb	MaryLamb
BALLROOM		
78	Valse Brillante Op 34 #3 In F Major	ValOpFMr
79	Musette In D Major	MusetDMr
80	Blue Bird Waltz	BlueBird
PIANO & KEYBOARD		
81	Yankee Doodle (Piano)	YankeeD2
82	Kaiser Walzer	Kaiser
83	Etude On Leger Lines 2	EtudeLL2
84	From A Story Book	StoryBok
85	Hanon Piano Fingering 1	Hanon1
86	Hanon Piano Fingering 2	Hanon2
87	Hanon Piano Fingering 3	Hanon3
88	Hanon Piano Fingering 4	Hanon4
89	Hanon Piano Fingering 5	Hanon5
90	Hanon Piano Fingering 6	Hanon6
91	Hanon Piano Fingering 7	Hanon7
92	Basic Tutorial Beyer Piano 8	Beyer8
93	Basic Tutorial Beyer Piano 12	Beyer12
94	Basic Tutorial Beyer Piano 13	Beyer13
95	Basic Tutorial Beyer Piano 14	Beyer14
96	Basic Tutorial Beyer Piano 15	Beyer15
97	Basic Tutorial Beyer Piano 16	Beyer16
98	Basic Tutorial Beyer Piano 18	Beyer18
99	Basic Tutorial Beyer Piano 19	Beyer19
100	Basic Tutorial Beyer Piano 20	Beyer20
101	Cuckoo	Cuckoo
102	Basic Tutorial Beyer Piano 21	Beyer21
103	Basic Tutorial Beyer Piano 29	Beyer29
104	Butterfly	Buterfly

105	Basic Tutorial Beyer Piano 45	Beyer45
106	Christmas Eve	XmasEve
107	Basic Tutorial Beyer Piano 50	Beyer50
108	Basic Tutorial Beyer Piano 52	Beyer52
109	Basic Tutorial Beyer Piano 55	Beyer55
110	Basic Tutorial Beyer Piano 59	Beyer59
111	Beyer Eight Degrees Jump Etude	BeyrJump
112	Basic Tutorial Beyer Piano The Scale Of C Major	BeyerC
113	Basic Tutorial Beyer Piano 65	Beyer65
114	Basic Tutorial Beyer Piano 66	Beyer66
115	Old Folks At Home (Piano)	OldFolk2
116	Basic Tutorial Beyer Piano The Scale Of G Major	BeyerG
117	Basic Tutorial Beyer Piano 70	Beyer70
118	Basic Tutorial Beyer Piano 72	Beyer72
119	Basic Tutorial Beyer Piano 73	Beyer73
120	Basic Tutorial Beyer Piano 74	Beyer74
121	A Little Polish Dance	PolishDc
122	Larghetto	Larghetto
123	Minuet 2	Minuet2
124	Prelude	Prelude
125	Duke Aria From "The Rigoletto"	DukeAria
126	Puck	Puck
127	The Happy Farmer	HpFarmer
128	Etude	Etude
129	Dance Of The Four Swans From "Swan Lake"	SwanLake
130	Jesus Saviour Pilot Me	Jesus
131	Old Macdonald Had A Farm	OldAFarm
132	2-Part Invention No.13 In A Minor BWV 784	Invetion
133	Musette	Musette
134	Bourree	Bourree
135	Carl Czerny 599 NO92	599No92
136	Away In A Manger	AwayInAM
137	Marriage Of Figaro	Marriage
138	Angels We Have Heard On High	Angles
139	Waltz	Waltz
140	Did You Ever See A Lassie	Lassie
141	Old France	OldFranc
142	Santa Claus Is Coming To Town	SantComn
143	Minuet 3	Minuet3
144	In The Theatre	Theatre
145	Alfredo And Violetta Column Tower Duet	Alfredo
146	Als Die Alte Mutter Mich Noch lehrte Singen	Mutter
147	At The Ball	AtBall
148	Dancing Raindrops	Raindrop
149	Comin'Round The Mountain	Mountain
150	Song Of The Brook	SofBrook
151	Cotton-pickin' Fingers	CtnPFngs
152	Menuett G Dur 3	MenuettG
153	Knight	Knight
154	Gavotte	Gavotte
155	The Angels Singing	Singing

MIDI Implementation Chart

Function		Transmitted	Recognized	Remarks
Basic Channel	Default	1ch	ALL	
	Changed	x	x	
Mode	Default	x	1	
	Messages	x	x	
	Altered	*****	x	
Note Number	Note	12-114	0-127	
	:True voice	*****	0-127	
Velocity	Note on	o 9nH,V=1-127	o 9nH,V=1-127	
	Note off	x (9nH,V=0)	o(9nH,V=0; 8nH,V=0-127)	
After Touch	key's	x	x	
	Ch's	x	x	
Pitch Bend		o	o	
Control Change	0	o	o	Bank Select
	1	x	o	Modulation
	5	x	x	Portamento Time
	6	x	o	Data Entry
	7	x	o	Volume
	10	x	o	Pan
	11	x	o	Expression
	64	o	o	Sustain Pedal
	65	x	x	Portamento ON/OFF
	66	x	o	Sostenuto Pedal
	67	x	o	Soft Pedal
	80	x	o	Reverb Program
	81	x	o	Chorus Program
	91	x	o	Reverb Level
	93	x	o	Chorus Level
	120	x	o	All Sound Off
	121	x	o	Reset All Controllers
123	o	o	All Notes Off	
Program Change	:true	*****	0-127	
System Exclusive		x	o	
System Common	:SongPosition	x	x	
	:Song Select	x	x	
	:Tune	x	x	
System Real Time	:Clock	x	x	
	:Commands	x	x	
Aux Messages	:LOCAL ON/OFF	x	x	
	:All Notes Off	o	o	
	:Active sense	x	o	
	:Reset	x	o	
Notes:				

- Mode 1: OMNI ON, POLY
- Mode 2: OMNI ON MONO

- Mode 3: OMNI OFF, POLY
- Mode 4: OMNI OFF, MONO

- x: NO
- o: YES



We love music!

WEEE-Declaration

Your product is designed and manufactured with materials and components of high quality, which are recyclable and can be reused.

The symbol means that your product should be disposed of separately from household waste when it reaches its end of life.

Please dispose of this equipment at your local collection point or recycling center.

Please help to protect the environment in which we all live.

Intellectual property /Copyright

All specifications and appearances are subject to change without notice.

All information was correct at time of printing. Musikhaus Kirstein GmbH does not guarantee for the accuracy or completeness of any description, photograph or statement contained in this manual.

Printed colours and specifications may vary slightly from product. Products from Musikhaus Kirstein GmbH

products are only sold through authorized dealers. Distributors and dealers are not agents of

Musikhaus Kirstein GmbH and have no authority to bind Musikhaus Kirstein GmbH legally in any way.

This manual is protected by copyright. Any copying or reprint, even in excerpts, is only allowed with written consent of Musikhaus Kirstein GmbH.

The same applies to reproduction or copying of images, even in altered form.



Musikhaus Kirstein GmbH

Bernbeurener-Str.11

D-86956 Schongau

Tel.0049-8861-909494-0

info@kirstein.de

www.kirstein.de