



# XDrum Drum Stool Semi

ArtNo. : 00006432



## Assembly instructions

Version: 05.2021

© 2021

These operating instructions are protected by copyright. Reproduction of these operating instructions, even in part, is only permitted with the permission of Musikhaus Kirstein GmbH. The same applies to the reproduction or copying of images, even in modified form.

### **Detailed safety instructions:**

- Read these instructions.
- Keep these instructions in a safe place.
- Heed all warnings. Follow all instructions.
- Clean the unit only with a dry cloth.
- Do not install near any heat sources such as radiators, heat registers, stoves, or other apparatus that produce heat.
- Contact qualified service personnel for all repair/maintenance work.

Thank you for choosing this product.

To ensure that you are fully satisfied with this drum stool, please read carefully and understand these assembly instructions before using our product. Keep these assembly instructions in a safe place. The assembly instructions must be passed on to all subsequent users.



Follow the operating instructions!



The signal word **WARNING** indicates hazards that can lead to serious injuries if no precautionary measures are taken.



The signal word **NOTE** indicates general precautions that should be observed when handling the product.



Images and screen representations in these assembly instructions may differ slightly from the appearance of the actual product, as long as this does not have a negative impact on the technical properties and safety of the product.



All person-related formulations in these assembly instructions are to be regarded as gender-neutral.

These assembly instructions apply to persons who have been supervised or instructed in the operation of the product by a person responsible for their safety and who have demonstrated their ability to handle the product.



**Children should be supervised to ensure that they do not play with the product.  
Do not leave children unattended.**

All information in these assembly instructions has been checked to the best of our knowledge and belief. However, neither the author nor the publisher can be held liable for any damage in connection with the use of these assembly instructions.

Other product, brand and company names mentioned in this document may be the trademarks of their respective owners. Compliance with all applicable copyright laws is the responsibility of the user of this document.

## Assembly of your XDrum drum stool:



(Fig.1)

Unfold the tripod and secure it for a firm stand with the lower wing screw. (Fig. 1)



(Fig. 2)

Insert the rod, which you will later use for height adjustment, into the three-legged stand and now use the wing screw to fix the desired seat height of the stool. (Fig.2)



(Fig. 3)

Finally, you can attach the seat to the top of the bar and fix it with a wing screw. The seat position is now height-adjustable from 50 cm to 62 cm. (Fig. 3)

**WEEE Declaration  
(Waste of Electrical and Electronic Equipment)**

Your product has been designed and manufactured using high quality materials and components that are recyclable and reusable. The symbol means that your product must be disposed of separately from household waste at the end of its life. Dispose of this appliance at your local collection point or recycling centre. Please help protect the environment in which we all live.

All technical data and appearances are subject to change without notice. All information was correct at the time of going to press. Musikhaus Kirstein GmbH does not guarantee the accuracy or completeness of the descriptions, photographs or statements contained in this manual. Printed colours and specifications may differ slightly from the product. Musikhaus Kirstein GmbH products are only sold through authorised distributors. Distributors and dealers are not representatives of Musikhaus Kirstein GmbH and are not authorised to legally bind Musikhaus Kirstein GmbH in any way.

** KIRSTEIN.de**

**Kirstein Music House GmbH  
Bernbeurener Str. 11  
86956 Schongau - Germany  
Phone: 0049-8861-909494-0  
Fax / Fax: 0049-8861-909494-19**

# Classic Cantabile KH-238 Kopfhörer HiFi dynamisch

ArtNr.: 00016331



## Bedienungsanleitung

Version: 10.2024

Vielen Dank, dass Sie sich für dieses Produkt entschieden haben. Um sicherzustellen, dass Sie mit dem Classic Cantabile Kopfhörer voll und ganz zufrieden sind, lesen Sie sorgfältig und verstehen Sie diese Bedienungsanleitung, bevor Sie unser Produkt verwenden. Bewahren Sie diese Bedienungsanleitung an einem sicheren Ort auf. Die Bedienungsanleitung muss an alle nachfolgenden Anwender weitergegeben werden.



Bedienungsanleitung beachten!



**WARNUNG**

Mit dem Signalwort **WARNUNG** sind die Gefahren gekennzeichnet, die ohne Vorsichtsmaßnahmen zu schweren Verletzungen führen können.



**HINWEIS**

Mit dem Signalwort **HINWEIS** sind allgemeine Vorsichtsmaßnahmen gekennzeichnet, die im Umgang mit dem Produkt beachtet werden sollen.



**HINWEIS**

Bilder und Bildschirmdarstellungen in dieser Bedienungsanleitung können vom Erscheinungsbild des tatsächlichen Produkts geringfügig abweichen, solange dies keine negativen Auswirkungen auf die technischen Eigenschaften und Sicherheit des Produkts hat.



**HINWEIS**

Alle personenbezogenen Formulierungen in dieser Bedienungsanleitung sind geschlechtsneutral zu betrachten.

Diese Bedienungsanleitung gilt für Personen, die von einer für ihre Sicherheit verantwortlichen Person beaufsichtigt oder in die Bedienung des Gerätes eingewiesen wurden und nachgewiesen haben mit dem Gerät umgehen zu können.



**WARNUNG**

**Kinder sollten beaufsichtigt werden, um sicherzustellen, dass sie nicht mit dem Kopfhörer spielen.  
Der Kopfhörer ist kein Spielzeug**

Alle Informationen in dieser Bedienungsanleitung wurden nach bestem Wissen und Gewissen kontrolliert. Weder Autor noch Herausgeber können jedoch für Schäden haftbar gemacht werden, die in Zusammenhang mit der Verwendung dieser Bedienungsanleitung stehen.

Sonstige, in diesem Dokument aufgeführte Produkt-, Marken- und Unternehmensbezeichnungen können die Warenzeichen ihrer jeweiligen Eigentümer sein. Die Einhaltung sämtlicher anwendbarer Urheberrechtsgesetze liegt in der Verantwortung des Anwenders dieses Dokuments.

---

**Detaillierte Sicherheitshinweise:****⚠ HINWEIS**

- Lesen Sie diese Anweisungen und bewahren Sie diese Anleitung auf.
- Beachten Sie alle Warnungen. Befolgen Sie alle Anweisungen.
- Verwenden Sie dieses Gerät nicht im Wasser.
- Reinigen Sie das Gerät nur mit einem trockenen Tuch.
- Legen Sie das Gerät nicht in auf Wärmequellen wie Heizkörpern, Öfen oder andere Geräte, die Wärme erzeugen.
- Achten Sie auf die Lautstärke! Hören mit zu hohem Lautstärkepegel kann Ihr Gehör dauerhaft schädigen.
- Wenden Sie sich bezüglich aller Reparatur- /Wartungsarbeiten an qualifiziertes Servicepersonal. Öffnen Sie das Gerät bzw. das Gehäuse nicht eigenmächtig. Eine Wartung ist erforderlich, wenn das Gerät auf irgendeine Weise beschädigt wurde, z. B. wenn das Kabel beschädigt ist, Flüssigkeit verschüttet wurde oder das Gerät Regen oder Feuchtigkeit ausgesetzt war, nicht ordnungsgemäß funktioniert.

**Beschreibung:****Funktion:**

Der Kopfhörer kann mit jedem Abspielgerät (z.B. CD-Player) als auch Instrument (z.B. E-Drumset, Keyboard oder Piano) verbunden werden. Hierbei ist je nach Buchse lediglich auf den Einsatz der korrekten 3,5 mm Klinke oder der 6,3 mm Klinke des Adapters zu achten.(Adapter liegt bei)

**⚠ WARNUNG**

Achten Sie auf die Lautstärke! Hören mit zu hohem Lautstärkepegel kann Ihr Gehör dauerhaft schädigen.

## Wartung

Ihr Gerät erfordert keine besondere Wartung. Wenden Sie sich jedoch im Falle einer Fehlfunktion an ein zugelassenes Servicecenter oder den Hersteller

## Reinigung

Verwenden Sie zur Reinigung ein fusselfreies und nur leicht feuchtes Tuch.

## Technische Spezifikationen:

**System:** dynamische Kopfhörer

**Nennimpedanz:** 32 Ohm

**Lautsprecher:** Stereo

**Frequenzbereich:** 20-20000 Hz

**Empfindlichkeit:** 110dB SPL

### WEEE-Erklärung

(Waste of Electrical and Electronic Equipment)

Ihr Produkt wurde unter Verwendung hochwertiger Materialien und Komponenten entwickelt und hergestellt, die recycelbar und wiederverwendbar sind. Das Symbol bedeutet, dass Ihr Produkt am Ende seiner Lebensdauer vom Hausmüll getrennt entsorgt werden muss.

Entsorgen Sie dieses Gerät bei Ihrer örtlichen Sammelstelle oder Recyclingstelle.

Bitte helfen Sie mit, die Umwelt zu schützen, in der wir alle leben.

Alle technischen Daten und Erscheinungsbilder können ohne vorherige Ankündigung geändert werden. Alle Angaben waren zum Zeitpunkt der Drucklegung korrekt. Die Musikhaus Kirstein GmbH übernimmt keine Gewähr für die Richtigkeit oder Vollständigkeit der in diesem Handbuch enthaltenen Beschreibungen, Fotos oder Aussagen. Gedruckte Farben und Spezifikationen können geringfügig vom Produkt abweichen. Produkte der Musikhaus Kirstein GmbH werden nur über autorisierte Händler vertrieben. Distributoren und Händler sind keine Vertreter der Musikhaus Kirstein GmbH und nicht befugt, die Musikhaus Kirstein GmbH in irgendeiner Weise rechtlich zu binden.

Diese Bedienungsanleitung ist urheberrechtlich geschützt. Die Vervielfältigung dieser Bedienungsanleitung, auch auszugsweise, ist nur mit Genehmigung der Musikhaus Kirstein GmbH gestattet. Gleiches gilt für die Vervielfältigung oder das Kopieren von Bildern, auch in geänderter Form.

© 2024

 **KIRSTEIN.de**

**Musikhaus Kirstein GmbH**

**Bernbeurener Str. 11**

**D-86956 Schongau**

**info@kirstein.de**

**www.kirstein.de**

**Telefon/Phone: +49(0)8861 / 90 94 94 -0**



# Classic Cantabile KH-238 Headphones HiFi dynamic

Item number: 00016331



## User Manual

Version: 10.2024

Thank you for choosing this product.

To ensure that you are fully satisfied with the Classic Cantabile headphones, read this manual carefully and understand these instructions before using our product. Keep these operating instructions in a safe place. The operating instructions must be passed on to all subsequent users.



Please carefully follow the instructions!



**WARNING**

The signal word **WARNING** indicates the dangers that can lead to serious injuries without precautionary measures.

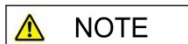

**NOTE**

The signal word **NOTE** indicates general precautionary measures that should be observed when handling the product.



**NOTE**

Images and screen shots in this manual may differ slightly from the appearance of the actual product as long as this has no negative effects on the technical properties and safety of the product.

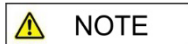

**NOTE**

All personal formulations in these operating instructions are to be considered gender-neutral.

These operating instructions apply to persons who have been supervised by a person responsible for their safety or who have been instructed in the operation of the device and have demonstrated that they can handle the device.



**WARNING**

**Children should be supervised to ensure that they do not play with the device.**

**Do not leave children unattended. The product is not a toy!**

All information in this operating manual has been checked to the best of our knowledge and belief. However, neither the author nor the publisher can be held liable for any damage associated with the use of this manual.

Other product, brand and company names mentioned in this document may be the trademarks of their respective owners. Compliance with all applicable copyright laws is the responsibility of the user of this document.

---

**Detailed safety information:****⚠ NOTE**

- Read these instructions. Keep these instructions.
- Heed all warnings. Follow all instructions.
- Do not use this device near water.
- Only clean the device with a dry cloth.
- Do not block any ventilation openings.
- Do not place the device near heat sources such as radiators, stoves or other devices that generate heat.
- Pay attention to the volume! Hearing at a high-volume level can permanently damage your hearing.
- Contact qualified service personnel for all repair / maintenance work. Do not open the device or the housing yourself. Maintenance is required if the device has been damaged in any way, e.g., if the power cord or plug is damaged, liquid has been spilled or objects have fallen into the device, the device has been exposed to rain or moisture, is not working properly or has been dropped.

**Function:**

The headphones can be connected to every playing device (e.g., CD-players) as well as instrument (e.g., E-drumset, keyboard or piano). It is only important to note which jack plug is required for the used device: the 3.5 mm jack or the 6.3 mm jack of the adapter. (Adapter is included in delivery)

**⚠ WARNING** Pay attention to the volume! Hearing at a high-volume level can permanently damage your hearing.

## Maintenance

Your device does not require any special maintenance. However, in the event of a malfunction, contact an approved service center or the manufacturer

## Cleaning

Use a lint-free and only slightly damp cloth for cleaning.

## Technical specifications:

**System:** dynamic headphones

**Impedance:** 32 Ohm

**Speakers:** Stereo

**Frequency range:** 20-20000 Hz

**Sensitivity:** 110dB SPL

### WEEE declaration (Waste of Electrical and Electronic Equipment)

Your product has been developed and manufactured using high quality materials and components that are recyclable and reusable. The symbol means that your product must be disposed of separately from household waste at the end of its service life.

Dispose of this device at your local collection or recycling centre, please help protect the environment we all live in.

All technical data and appearances are subject to change without notice. All information was correct at the time of printing. Musikhaus Kirstein GmbH assumes no liability for the correctness or completeness of the descriptions, photos or statements contained in this manual. Printed colours and specifications may differ slightly from the product. Musikhaus Kirstein GmbH products are only sold through authorized dealers. Distributors and dealers are not representatives of Musikhaus Kirstein GmbH and are not authorized to bind Musikhaus Kirstein GmbH legally in any way.

This manual is protected by copyright. Reproduction of these operating instructions, in whole or in part, is only permitted with the approval of Musikhaus Kirstein GmbH. The same applies to the duplication or copying of images, even in modified form.

© 2024

 **KIRSTEIN.de**

**Musikhaus Kirstein GmbH**

**Bernbeurener Str. 11**

**D-86956 Schongau**

**info@kirstein.de**

**www.kirstein.de**

**Phone: +49(0)8861 / 90 94 94 -0**



# ***DIGITAL DRUM***

## Owner's Manual

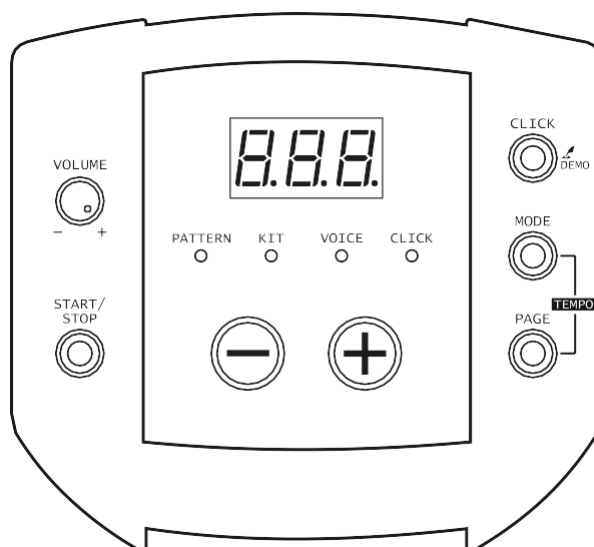

# INFORMATION FOR YOUR SAFETY!

## THE FCC REGULATION WARNING (for USA)

This equipment has been tested and found to comply with the limits for a Class B digital device, pursuant to Part 15 of the FCC Rules.

These limits are designed to provide reasonable protection against harmful interference in a residential installation. This equipment generates, uses, and can radiate radio frequency energy and, if not installed and used in accordance with the instructions, may cause harmful interference to radio communications. However, there is no guarantee that interference will not occur in a particular installation.

If this equipment does cause harmful interference to radio or television reception, which can be determined by turning the equipment off and on, the user is encouraged to try to correct the interference by one or more of the following measures:

- Reorient or relocate the receiving antenna.
- Increase the separation between the equipment and receiver.
- Connect the equipment to an outlet on a circuit different from that to which the receiver is connected.
- Consult the dealer or an experienced radio/TV technician for help.

Unauthorized changes or modifications to this system may void the user's authority to operate this equipment.

### CAUTION

The normal function of the product may be disturbed by strong electromagnetic interference. If so, simply reset the product to resume normal operation by following the owner's manual. If the function cannot be resumed, please use the product in another location.

### CAUTION

Changes or modifications not expressly approved by the party responsible for compliance could void the user's authority to operate the equipment.

## PRECAUTIONS

### PLEASE READ CAREFULLY BEFORE PROCEEDING

Please keep this manual in a safe place for future reference.

#### Power Supply

Please connect the designated AC adapter to an AC outlet of the correct voltage.

Do not connect it to an AC outlet of voltage other than that for which your instrument is intended.

Unplug the AC power adapter when not using the instrument, or during electrical storms.

#### Connections

Before connecting the instrument to other devices, turn off the power to all units. This will help prevent malfunction and / or damage to other devices.

#### Location

Do not expose the instrument to the following conditions to avoid deformation, discoloration, or more serious damage:

- Direct sunlight
- Extreme temperature or humidity
- Excessively dusty or dirty locations
- Strong vibrations or shocks
- Close to magnetic fields

#### Interference with other electrical devices

Radios and televisions placed nearby may experience reception interference. Operate this unit at a suitable distance from radios and televisions.

#### Cleaning

Clean only with a soft, dry cloth.

Do not use paint thinners, solvents, cleaning fluids, or chemical-impregnated wiping cloths.

#### Handling

Do not apply excessive force to the switches or controls.

Do not allow paper, metallic, or other objects to enter the instrument. If this happens, unplug the AC adapter from the wall outlet. Then have the instrument inspected by qualified service personnel.

Disconnect all cables before moving the instrument.

# Contents

## Panel Description

Front Panel.....	4
Rear Panel .....	4

## Setup

Connect the pads and the pedal.....	5
-------------------------------------	---

## Connections

Connect to audio equipment.....	6
Connect a CD player, etc. (aux in jack).....	6
Connect head .....	6
Connect the power supply jack.....	6
MIDI and USB .....	6

## MENU

menu tree.....	7
----------------	---

## Operation

Switch the power ON.....	7
Auto Power Off .....	7
Set the main volume .....	7

## Pattern

Select a pattern .....	8
Adjust the accompaniment volume.....	8
Adjust the drum volume.....	8

## Drum Kit

Select a kit.....	9
Adjust the kit volume .....	9

Switch reverb on/off.....	9
---------------------------	---

## Voice

Select the voice.....	10
Adjust the voice volume .....	10
Adjust the MIDI note.....	11

## Tempo

Adjust the tempo .....	11
------------------------	----

## Click

Adjust the click time signature .....	12
Adjust the click interval.....	12
Adjust the click instrument.....	12
Adjust the click volume.....	12

<b>Restore the factory preset.....</b>	<b>13</b>
--	-----------

<b>Play the demo.....</b>	<b>13</b>
---------------------------	-----------

<b>Play the pattern .....</b>	<b>13</b>
-------------------------------	-----------

<b>Play the click .....</b>	<b>13</b>
-----------------------------	-----------

## Appendices

Specifications .....	14
Preset drum kit list.....	15
Drum Instrument List .....	15
Preset Pattern List.....	15
GM backing instrument list .....	16
GM Drum Kit List.....	18
MIDI Implementation Chart.....	19

# Panel Description

## Front Panel

- 1 MASTER VOLUME KNOB**  
Control the volume of the phone and line out.  
Turn it clockwise to increase the volume and anticlockwise to decrease the volume.
- 2 [ START/STOP ] BUTTON**  
Start or stop pattern playback.
- 3 3-DIGIT LED DISPLAY**  
3-digit LED and LED indicators
- 4 [CLICK] BUTTON**  
Press the [click] button to start/stop the click.  
**Hold down the [click] button for 2 seconds to enter demo mode and play the demo.**
- 5 [MODE] BUTTON**  
Press the [mode] button to select the mode from PATTERN, KIT, VOICE, CLICK.
- 6 PAGE BUTTON**  
Press the [page] button to browse the menu pages of the currently selected mode.  
**Press both [mode] and [page] buttons, the 3-digit LED will display the tempo page, it will temporarily display for 3 seconds, then press [+] or [-] to adjust the volume.**
- 7 [ + ]/[ - ] BUTTON**  
Press the [+]/[-] button to adjust the parameters.

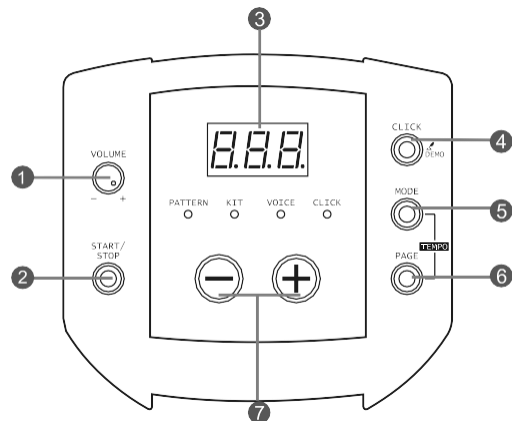

## Rear Panel

- 8 POWER SUPPLY JACK ( DC IN 9V )**  
Connect an AC adapter to this jack.
- 9 POWER SWITCH**  
Turn the power on/off.
- 10 USB PORT**  
Connect to computer.
- 11 MIDI OUT JACK**  
Connect to external sound module.
- 12 LINE OUTPUT JACKS (R, L/MONO)**  
Made up of right channel output and left channel output which is also used as mono line output.
- 13 AUX IN**  
Connect to an external sound source.
- 14 PHONES JACK**  
Connect a pair of stereo headphones to this jack.  
(Connecting the headphones will not mute the output jack.)

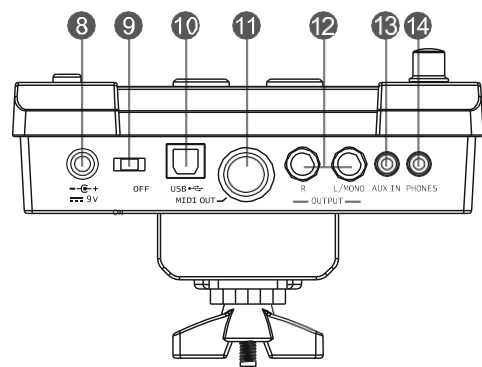

## Caution

To prevent electric shock and damage to the device, make sure the power is switched OFF on the drum and all related devices before making any connections.

### Connecting Pads and Pedals

Using the provided cables, connect the cable marked with the corresponding drum pads, cymbal pads, and pedals. (See the illustration below for reference)

**Note:**

1. The sound of the hi-hat pad is controlled by the hi-hat pedal. Similar to a real drum kit, the hi-hat pad functions as an 'open hi-hat' when the pedal is released. When the pedal is stepped, it functions as a 'closed hi-hat'.
2. The valid striking area of the cymbal pad (ride, crash, or hi-hat) is near the edge of the pad, which is different from other pads.

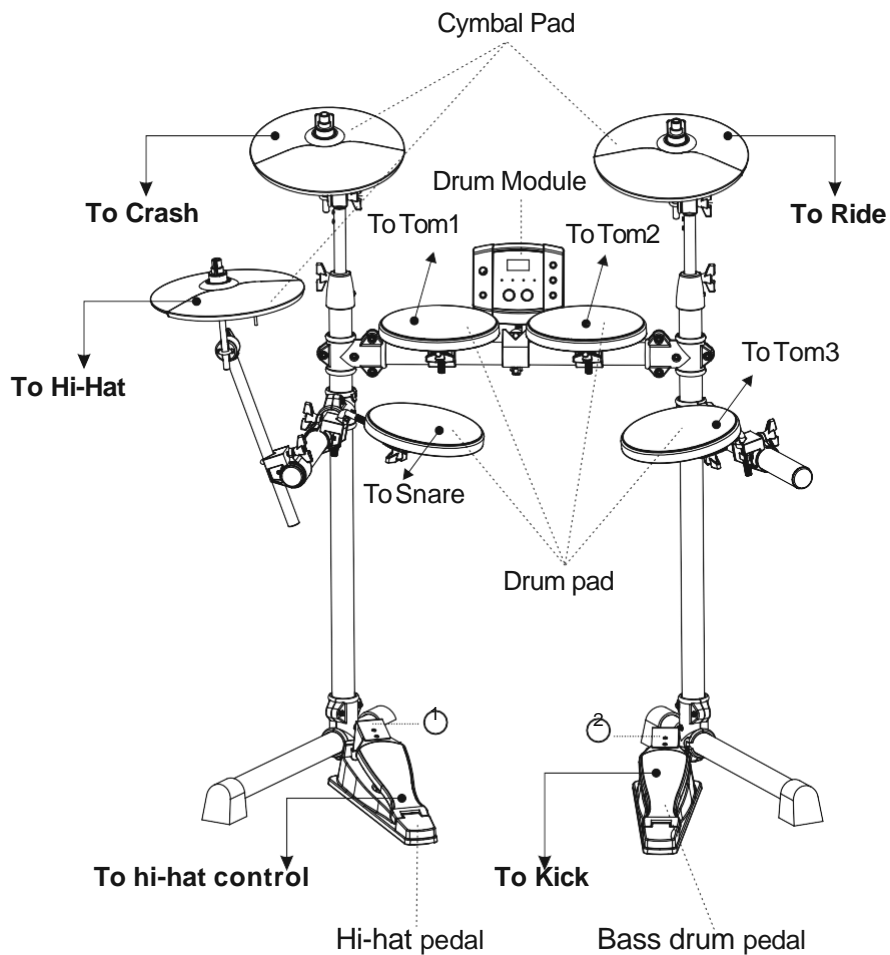

# Connections

## Connect to audio equipment

1. When you want to listen to the voices with an amplifier, connect amplifiers with the Output L/MONO and R jacks on the rear panel. (For monaural playback, use the L/MONO jack; for stereo playback, connect both L/MONO and R jacks.)
2. The volume is adjusted with the VOLUME knob.

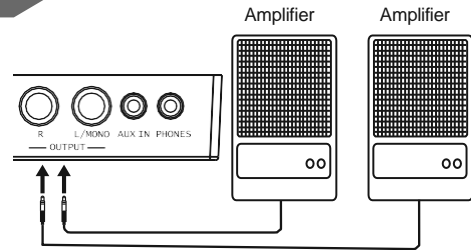

1. The audio output of a CD player or other audio source connected to the AUX IN jack on the rear panel can be mixed with the sound of the drum. This function that let you play along with a favorite song.
2. The volume of the external signal is adjusted with the VOLUME knob.

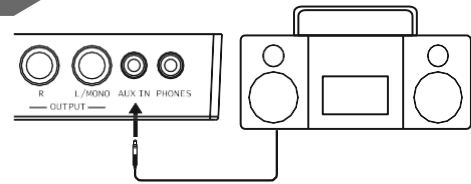

## Connect headphones

An optional set of stereo headphones can be connected to the PHONES jack located on the rear panel of the drum module.

- \* Adjust the volume to a comfortable level.

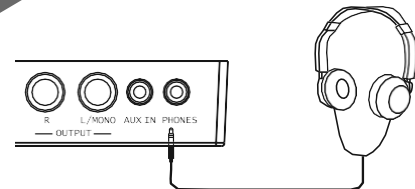

## Connect the power supply jack

Make sure the power is switched OFF and connect the power adapter to the DC IN jack on the rear panel.

### Note:

1. To protect the speakers, amplifier, and drum module from damage, turn the volume knob to the minimum volume level before turning the power ON.
2. Make sure the power is switched OFF when connecting the drum module to external devices.

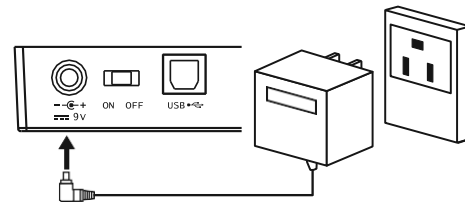

## MIDI and USB

MIDI stands for Musical Instrument Digital Interface, which is a worldwide standard communication interface that enables electronic musical instruments and computers (of all brands) to communicate with each other so that MIDI commands and other data can pass between them. This exchange of information makes it possible to create a system of MIDI instruments and devices that offer far greater versatility and control than is available with isolated instruments. Whether you interface with computers, sequencers, expanders or other controllers, your musical horizons will be greatly enhanced.

### MIDI connection

MIDI OUT: This terminal transmits data from this instrument to other MIDI devices.

### USB connection

The USB connector allows you to connect the module directly to your computer. It can be connected without driver installation under Windows XP, Vista, Windows 7, and MAC OSX. The module will be recognized as a "USB audio device" to receive and transmit MIDI messages through a single USB cable. USB is used only for MIDI messages (MIDI via USB).

- Note:** When the USB is connected to a computer, all MIDI messages will be received and transmitted via USB.

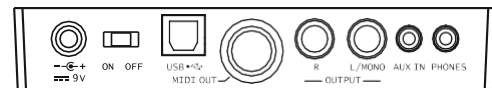

## Menu tree

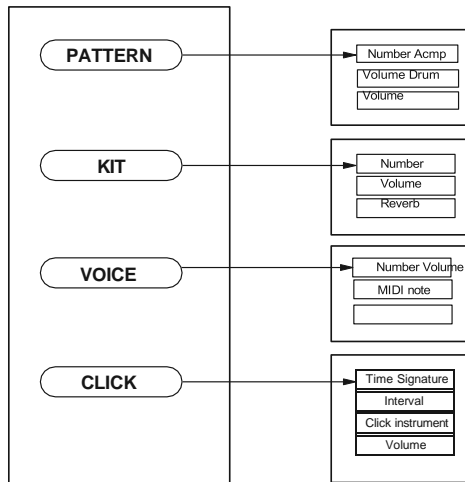

In the main menu there are 4 menu items

- PATTERN
- DRUM KIT
- VOICE
- CLICK

## Operation

Press the [MODE] button to change the mode.  
 Press the [PAGE] button to select the page of the current mode.  
 Press the [+] / [-] button to adjust the parameters.

### Switch the power ON

After confirming that all connections have been completed, rotate the volume knob to the left (minimum volume level) before switching the power on.

Set the power switch to the "ON" position to switch on the power.  
 The display shows the kit number and its indicator lights up.

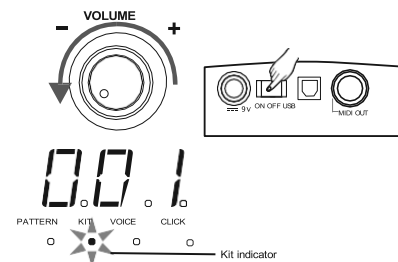

### Auto Power Off

In order to save energy, we have designed the "Automatic Shutdown" function. With this function, this product will shut down automatically when you have left it idle for more than 15 minutes. If you don't need this function, just press and hold the [START/STOP] button and then turn the drum on. You will also see the screen temporarily displaying "PoF" for 3 seconds before entering the main menu, which indicates that the "Automatic shutdown" function is turned off. This feature will reset to factory settings by rebooting the device. Please note that the device may consume more power when this feature is disabled. Power consumption after automatic shutdown: < 0.3 W (less than 0.3 W)



### Set the main volume

While hitting a pad, gradually rotate the volume knob until a comfortable volume level is reached.



# Pattern

In pattern mode, there are 3 pages:

1. Pattern number (1- 40, default 1)
2. Pattern accompaniment volume (0-32)
3. Pattern drum volume (0-32)

## Select a pattern

In pattern mode, pattern number (001-040, default 001)

1. Press the [MODE] button to select the pattern mode, the pattern LED indicator will light up, and the 3-digit LED will display the pattern number (001).
2. Press the [+] or [-] button to adjust the value. Range: (001 to 040)

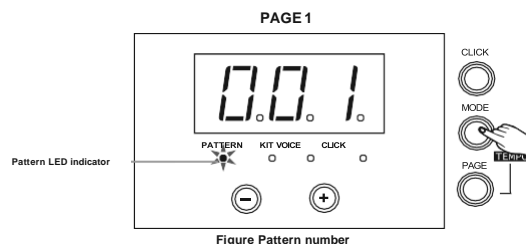

## Adjust the accompaniment volume

In pattern mode, pattern accompaniment volume (0-032)

1. Press the [MODE] button to select the pattern mode, the pattern LED indicator will light up.
2. Press the [PAGE] button to select the accompaniment volume page; the 3-digit LED will display the accompaniment volume (A22).
3. Press the [+] or [-] button to adjust the value. Range: (0 to 32).

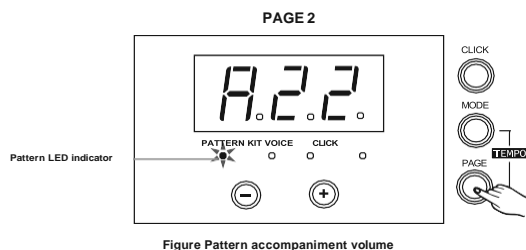

## Adjust the drum volume

In pattern mode, pattern drum volume (0-032)

1. Press the [MODE] button to select the pattern mode, the pattern LED indicator will light up,
2. Press the [PAGE] button to select the drum volume page, the 3-digit LED will display the drum volume (d22).
3. Press [+] or [-] to adjust the value. Range: (0 to 32)

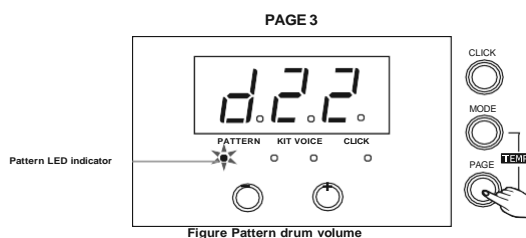

# Drum Kit

In kit mode, there are 3 pages:

1. Kit number (001-010, default 1).
2. Kit volume (0-32).
3. Kit reverb: (on/off, default on).

## Select a kit

In kit mode, kit number (001-010, default 1).

1. Press the [MODE] button to select the kit mode, the kit LED indicator will light up, and the 3-digit LED will display the kit number (001).
2. Press [+ ] or [-] to adjust the value.  
Range: (001-010).

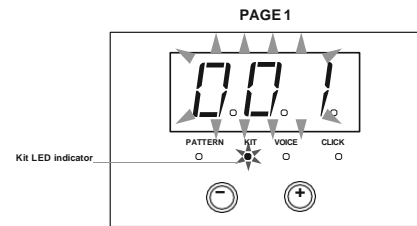

## Adjust the kit volume

In kit mode, kit volume (0-32).

1. Press the [MODE] button to select the kit mode, the kit LED indicator will light up.
2. Press the [PAGE] button to select the kit volume page, the 3-digit LED will display the kit volume (L30).
3. Press [+] or [-] to adjust the value (Automatic save).  
Range: (0 to 32).

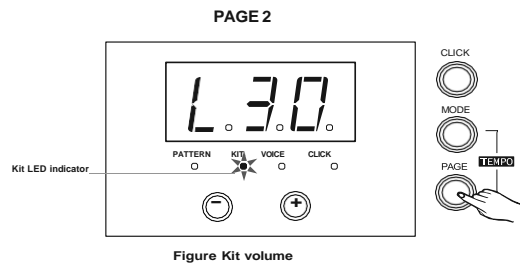

## Switch reverb on/off

1. Press the [MODE] button to select the kit mode; the kit LED indicator will light up.
2. Press the [PAGE] button to select the kit reverb page, The reverb effect can be turned on or off by pressing the [+] or [-] button.

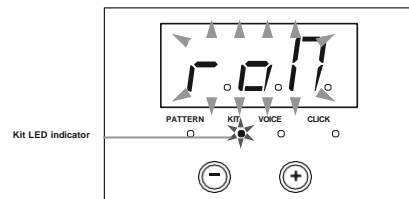

PAGE 3

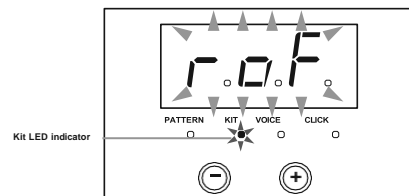

# Voice

In voice mode, there are 3 pages:

1. Voice number: (1-108).
2. Voice volume: (0-32).
3. Midi note: (0-99).

## Select the voice

In voice mode, voice number: (1-108).

1. Press the [MODE] button to select the voice mode. the voice LED indicator will light up, strike a drum pad, and the 3-digit LED will display the voice number.
2. Press [+] or [-] to adjust the value (automatic save). Range: (001 to 108).

### NOTE:

When you select a voice for hi-hit drum, you can only select the hi-hat group voices from group 1 to group 4 (automatic save), the display is: (H-I).

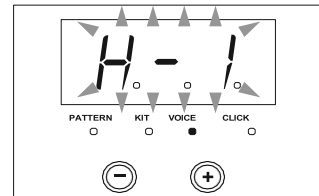
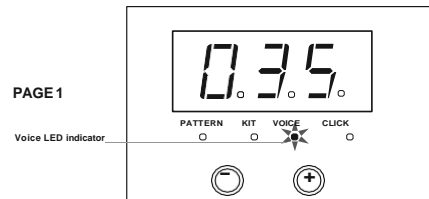

## Adjust the voice volume

In voice mode, voice volume: (0-32).

1. Press the [MODE] button to select the voice mode; the voice LED indicator will light up.
2. Press the [PAGE] button to select the voice volume page, strike a drum pad, the 3-digit LED will display the voice volume (L30).
3. Press [+] or [-] to adjust the value (automatic save). Range: (0 to 32).



## Adjust the MIDI note

In voice mode, MIDI note: (0-99).

1. Press the [MODE] button to select the voice mode; the voice LED indicator will light up.
2. Press [PAGE] button to select the midi note page, strike a drum pad, the 3-digit LED will display the midi note (n48).
3. Press [+] or [-] to adjust the value (automatic save).  
Range: (0 to 99).



### THE DEFAULT MIDI NOTE:

NO.	NAME	NOTE
1	CRASH1	49
2	TOM 1	48
3	TOM 2	45
4	TOM 3	43
5	RIDE	51
6	KICK	36
7	SNARE	38
8	HIHAT CLOSE	42
9	HIHAT OPEN	46
10	HIHAT PEDAL	44

## Tempo

The tempo range is 30-280

## Adjust the tempo

1. Press both [MODE] and [ PAGE ] buttons, the 3-digit LED will display the tempo page, it will temporarily display for 3 seconds.
2. Press [+] or [-] to adjust the value.

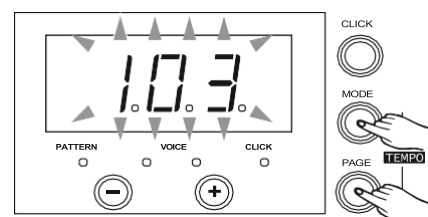

# Click

In click mode, there are 4 pages:

1. Time signature: (1/4-7/4, 3/8, 6/8).
- 2.
3. Instrument: (1-5, default 1).
4. Click volume: (0-32).

## Adjust the click time signature

In click mode, Time signature: (1/4-7/4, 3/8, 6/8).

1. Press the [MODE] button to select the click mode; the click LED indicator will light up.
2. Press the [PAGE] button to select the click time signature page, the 3-digit LED will display the click time signature (4-4).
3. Press [+] or [-] to adjust the value.  
Range: (1/4-7/4 or 3/8 or 6/8).

**Note:** The click time signature will follow the pattern; when the pattern is playing, it cannot be edited.

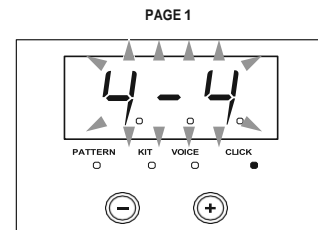

## Adjust the click interval

In click mode, interval: (1/4, 1/8, 1/12, 1/16, 1/24, default 1/4).

1. Press [MODE] button to select the click mode, the click LED indicator will light up.
2. Press the [PAGE] button to select the click interval page, the 3-digit LED will display the click interval (--4).
3. Press the [+] or [-] button to adjust the value.  
Range: (--4 to -24).

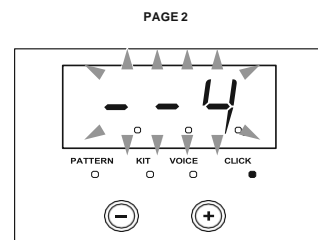

## Adjust the click instrument

In click mode, instrument: (1-5, default 1).

1. Press the [MODE] button to select the click mode, the click LED indicator will light up.
2. Press the [PAGE] button to select the click instrument page, the 3-digit LED will display the click instrument (CL1).
3. Press [+] or [-] to adjust the value.  
Range: (CL1 to CL5).

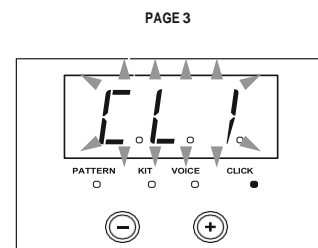

## Adjust the click volume

In click mode, click volume: (0-32).

1. Press [MODE] button to select the click mode, the click LED indicator will light up.
2. Press [PAGE] button to select the click volume page, the 3-digit LED will display the click volume (L24).
3. Press [+] or [-] to adjust the value.  
Range: (0 to 32)

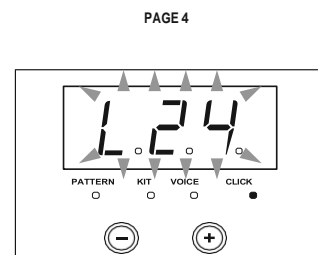

# Restore the factory preset

Restoring the factory preset can be implemented by following operations:

Turn on the power with both [ + ] and [ - ] unreleased.

This function will replace the current settings of the following parameters with their default preset values:

Kit volume, voice number, voice volume, and MIDI note.

## Play the " " demo

1. Hold down the [CLICK] button for 2 seconds to enter the demo and play the demo; the 3-digit LED will display the demo "dE".
2. Press the [START/STOP] button to stop the demo playing.

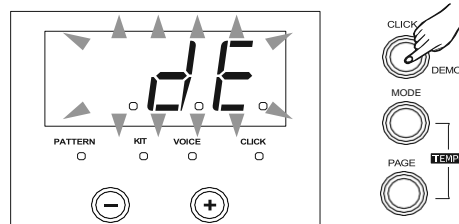

## Play the pattern

1. Press the [START/STOP] button to play the pattern.
2. Press the [START/STOP] button again to stop the pattern playing.

## Play the " " click

1. Press the [CLICK] button to start the click, the click indicator will flash follow the beat.
2. Press the [CLICK] button again to stop the click.

# Specifications

**Drum Pad**

4 drum pads, 3 cymbal pads, 1 hi-hat control pedal, 1 kick pedal

**Preset drum kits**

10 preset kits

**Drum instrument**

10

**Preset patterns**

4

**Control**

MIDI OUT, POWER SWITCH, USB, PHONES, START/STOP, PATTERN, KIT, VOICE, CLICK, MODE, PAGE, DEMO, TEMPO, VOLUME, + / -

**Display**

LED display

**Connections**

PHONES  
AUX IN  
OUTPUT (R & L/MONO)  
MIDI OUT  
USB  
ON/OFF

**Power supply**

AC adapter (9V)



# GM backing instrument List

## PIANO

- 1 Acoustic Grand Piano
- 2 Bright Acoustic Piano
- 3 Electric Grand Piano
- 4 Honky-Tonk Piano
- 5 E.Piano 1
- 6 E.Piano 2
- 7 Harpsichord
- 8 Clavi

## MALLET

- 9 Celesta
- 10 Glockenspiel
- 11 Music box
- 12 Vibraphone
- 13 Marimba
- 14 Xylophone
- 15 Tubular bells
- 16 Dulcimer

## ORGAN

- 17 drawbar organ
- 18 Percussive Organ
- 19 Rock organ
- 20 Church Organ
- 21 Reed organ
- 22 Accordion
- 23 Harmonica
- 24 Tango accordion

## GUITAR

- 25 nylon guitar
- 26 Steel Guitar
- 27 Jazz Guitar
- 28 Clean Guitar
- 29 Muted Guitar
- 30 Overdriven Guitar
- 31 Distortion Guitar
- 32 Guitar harmonics

## BASS

- 33 Acoustic Bass
- 34 Finger Bass
- 35 Pick Bass
- 36 Fretless bass
- 37 Slap bass 1
- 38 Slap bass 2
- 39 Synth Bass 1
- 40 Synth Bass 2

## STRINGS

- 41 Violin
- 42 Viola
- 43 Cello
- 44 Double bass
- 45 Tremolo strings
- 46 Pizzicato Strings
- 47 Orchestral Harp
- 48 Timpani

## STRINGS ENSEMBLE

- 49 Strings Ensemble 1
- 50 Strings Ensemble 2
- 51 Synth Strings 1
- 52 Synth Strings 2
- 53 Choir Aahs
- 54 Voice Oohs
- 55 Synth Voice
- 56 Orchestra Hit

## BRASS

- 57 Trumpet
- 58 Trombone
- 59 Tuba
- 60 Muted trumpet
- 61 French horn
- 62 Brass Section
- 63 Synth Brass 1
- 64 Synth Brass 2

## REED

- 65 Soprano Sax
- 66 Alto Sax
- 67 Tenor Sax
- 68 Baritone saxophone
- 69 Oboe
- 70 English horn
- 71 Bassoon
- 72 Clarinet

## PIPE

- 73 Piccolo
- 74 Flute
- 75 Recorder
- 76 Pan flute
- 77 Blown Bottle
- 78 Shakuhachi
- 79 Whistle
- 80 Ocarina

## LEAD

- 81 Lead1 (square)
- 82 Lead2 (sawtooth)
- 83 Lead3 (calliope)
- 84 Lead4 (chiff)
- 85 Lead 5 (charang)
- 86 Lead6 (voice)
- 87 Lead7 (fifths)
- 88 Lead8 (bass & Lead)

## PAD

- 89 Pad1 (new age)
- 90 Pad2 (warm)
- 91 Pad3 (polysynth)
- 92 Pad4 (choir)
- 93 Pad5 (bowed)
- 94 Pad6 (metallic)
- 95 Pad7 (halo)
- 96 Pad8 (sweep)

## EFFECTS

- 97 FX1 (rain)
- 98 FX2 (soundtrack)
- 99 FX3 (crystal)
- 100 FX4 (atmosphere)
- 101 FX5 (brightness)
- 102 FX6 (goblins)
- 103 FX7 (echoes)
- 104 FX8 (sci-fi)

## ETHNIC

- 105 Sitar
- 106 Banjo
- 107 Shamisen
- 108 Koto
- 109 Kalimba
- 110 Bagpipe
- 111 Fiddle
- 112 Shanai

## PERCUSSIVE

- 113 Tinkle Bell
- 114 Agogo
- 115 Steel drums
- 116 Wood Block
- 117 Taiko drum
- 118 Melodic tom
- 119 Synth drum
- 120 Reverse cymbal

## SOUND EFFECTS

- 121 Guitar Fret Noise
- 122 Breath Noise
- 123 Seashore
- 124 Bird Tweet
- 125 Telephone Ring
- 126 Helicopter
- 127 Applause
- 128 Gunshot

# GM drum kit list

NET NO	Standard 1 (bank 0)	Standard 2 (bank 4)	Room (bench 8)	Rock (bank 16)	Funk (bank 17)
27-D#1	High Q	&lt;-	&lt;-	&lt;-	&lt;-
28-E1	Slap	&lt;-	&lt;-	&lt;-	&lt;-
29-F1	Scratch Push	&lt;-	&lt;-	&lt;-	&lt;-
30-F#1	Scratch Pull	&lt;-	&lt;-	&lt;-	&lt;-
31-G1	Sticks	&lt;-	&lt;-	&lt;-	&lt;-
32-G#1	Square Click	&lt;-	&lt;-	&lt;-	&lt;-
33-A1	Metronome Click	&lt;-	&lt;-	&lt;-	&lt;-
34-A#1	Metronome Bell	&lt;-	&lt;-	&lt;-	&lt;-
35-B1	Acoustic Bass Drum	&lt;-	Room Bass Drum 1	Rock Bass Drum 1	Funk Bass Drum 1
36-C2	Standard 1 Bass Drum	Standard 2 Bass Drum	Room Bass Drum 2	Rock Bass Drum 2	Funk Bass Drum 2
37-C#2	Side Stick	&lt;-	&lt;-	&lt;-	&lt;-
38-D2	Standard 1 snare	Standard 2 snare	Room snare	Rock snare	Funk snare
39-D#2	Hand Clap	&lt;-	&lt;-	&lt;-	&lt;-
40-E2	Standard 1 snare rim	Standard 2 snare rim	Room Snare Rim	Rock Snare Rim	Funk Snare Rim
41-F2	Standard 1 Tom 6	Standard 2 tom 6	Room Tom 6	Rock Tom 6	Funk Tom 6
42-F#2	Standard 1 Hi-hat Close	Standard 2 Hi-hat Close	Room Hi-hat Close	Rock Hi-hat Close	Wireless hi-hat close
43-G2	Standard 1 tom 5	Standard 2 tom 5	Room tom 5	Rock Tom 5	Funk Tom 5
44-G#2	Standard 1 Hi-hat pedal	Standard 2 hi-hat pedal	Room hi-hat pedal	Rock hi-hat pedal	Funk hi-hat pedal
45-A2	Standard 1 tom 4	Standard 2 tom 4	Room Tom 4	Rock Tom 4	Funk Tom 4
46-A#2	Standard 1 Hi-hat Open	Standard 2 Hi-hat Open	Room hi-hat open	Rock hi-hat open	Funk hi-hat open
47-B2	Standard 1 Tom 3	Standard 2 Tom 3	Room Tom 3	Rock Tom 3	Funk Tom 3
48-C3	Standard 1 Tom 2	Standard 2 Tom 2	Room Tom 2	Rock Tom 2	Funk Tom 2
49-C#3	Standard 1 Crash 1	Standard 2 Crash 1	Room Crash 1	Rock crash 1	Funk crash 1
50-D3	Standard 1 Tom 1	Standard 2 Tom 1	Room Tom 1	Rock Tom 1	Funk Tom 1
51-D#3	Standard 1 Ride	Standard 2 Ride	Room Ride	Rock Ride	Funk Ride
52-E3	Chinese Cymbal 1	&lt;-	&lt;-	&lt;-	&lt;-
53-F3	Ride Bell	&lt;-	Room Ride Bell	Rock Ride Bell	&lt;-
54-F#3	Tambourine	&lt;-	&lt;-	&lt;-	&lt;-
55-G3	Splash cymbal	&lt;-	Room Splash Cymbal	Rock Splash Cymbal	&lt;-
56-G#3	Standard 1 Cowbell	Standard 2 Cowbell	Room Cowbell	Rock cowbell	&lt;-
57-A3	Standard 1 crash 2	Standard 2 crash 2	Room Crash 2	Rock Crash 2	Funk Crash 2
58-A#3	Vibra-slap	&lt;-	&lt;-	&lt;-	&lt;-
59-B3	Ride Cymbal	&lt;-	&lt;-	&lt;-	&lt;-
60-C4	Hi Bongo	&lt;-	&lt;-	&lt;-	&lt;-
61-C#4	Low bongo	&lt;-	&lt;-	&lt;-	&lt;-
62-D4	Mute Hi Conga	&lt;-	&lt;-	&lt;-	&lt;-
63-D#4	Open Hi Conga	&lt;-	&lt;-	&lt;-	&lt;-
64-E4	Low Conga	&lt;-	&lt;-	&lt;-	&lt;-
65-F4	High Timbale	&lt;-	&lt;-	&lt;-	&lt;-
66-F#4	Low Timbale	&lt;-	&lt;-	&lt;-	&lt;-
67-G4	High Agogo	&lt;-	&lt;-	&lt;-	&lt;-
68-G#4	Low Agogo	&lt;-	&lt;-	&lt;-	&lt;-
69-A4	Cabasa	&lt;-	&lt;-	&lt;-	&lt;-
70-A#4	Maracas	&lt;-	&lt;-	&lt;-	&lt;-
71-B4	Short Whistle	&lt;-	&lt;-	&lt;-	&lt;-
72-C5	Long Whistle	&lt;-	&lt;-	&lt;-	&lt;-
73-C#5	Short Guiro	&lt;-	&lt;-	&lt;-	&lt;-
74-D5	Long Guiro	&lt;-	&lt;-	&lt;-	&lt;-
75-D#5	Claves	&lt;-	&lt;-	&lt;-	&lt;-
76-E5	Hi Wood Block	&lt;-	&lt;-	&lt;-	&lt;-
77-F5	Low Wood Block	&lt;-	&lt;-	&lt;-	&lt;-
78-F#5	Mute Cuica	&lt;-	&lt;-	&lt;-	&lt;-
79-G5	Open Cuica	&lt;-	&lt;-	&lt;-	&lt;-
80-G#5	Mute Triangle	&lt;-	&lt;-	&lt;-	&lt;-
81-A5	Open Triangle	&lt;-	&lt;-	&lt;-	&lt;-
82-A#5	Shaker	&lt;-	&lt;-	&lt;-	&lt;-
83-B5	Jingle Bell	&lt;-	&lt;-	&lt;-	&lt;-
84-C6	Bell Tree	&lt;-	&lt;-	&lt;-	&lt;-
85-C#6	Castanets	&lt;-	&lt;-	&lt;-	&lt;-
86-D6	Mute Surdo	&lt;-	&lt;-	&lt;-	&lt;-
87-D#6	Open Surdo	&lt;-	&lt;-	&lt;-	&lt;-

# GM Drum Kit List

NET NO	Electronic (bank 24)	808 (bank 25)	House (bank 28)	Jazz (bank 32)	Brush (bank 40)
27-D#1	&lt;-	&lt;-	&lt;-	&lt;-	&lt;-
28-E1	&lt;-	&lt;-	&lt;-	&lt;-	&lt;-
29-F1	&lt;-	&lt;-	&lt;-	&lt;-	&lt;-
30-F#1	&lt;-	&lt;-	&lt;-	&lt;-	&lt;-
31-G1	&lt;-	&lt;-	&lt;-	&lt;-	&lt;-
32-G#1	&lt;-	&lt;-	&lt;-	&lt;-	&lt;-
33-A1	&lt;-	&lt;-	&lt;-	&lt;-	&lt;-
34-A#1	&lt;-	&lt;-	&lt;-	&lt;-	&lt;-
35-B1	Electronic Bass Drum 1	808 Bass Drum 1	House Bass Drum 1	Jazz Bass Drum 1	Brush bass drum 1
36-C2	Electronic Bass Drum 2	808 Bass Drum 2	House Bass Drum 2	Jazz Bass Drum 2	Brush Bass Drum 2
37-C#2	&lt;-	&lt;-	&lt;-	&lt;-	&lt;-
38-D2	Electronic Snare	808 Snare	House Snare	Jazz Snare	Brush Snare
39-D#2	&lt;-	&lt;-	House Hand Clap	&lt;-	&lt;-
40-E2	Electronic Snare Rim	808 Snare Rim	House Snare Rim	Jazz Snare Rim	Brush Snare Rim
41-F2	Electronic Tom 6	808 Tom 6	House Tom 6	Jazz Tom 6	Brush Tom 6
42-F#2	Electronic Hi-hat Close	808 Hi-hat Close	House hi-hat close	Jazz hi-hat close	&lt;-
43-G2	Electronic Tom 5	808 Tom 5	House Tom 5	Jazz Tom 5	Brush Tom 5
44-G#2	Electronic Hi-hat Pedal	808 Hi-hat Pedal	House hi-hat pedal	Jazz Hi-hat Pedal	&lt;-
45-A2	Electronic Tom 4	808 Tom 4	House Tom 4	Jazz Tom 4	Brush Tom 4
46-A#2	Electronic Hi-hat Open	808 Hi-hat Open	House Hi-hat Open	Jazz Hi-hat Open	&lt;-
47-B2	Electronic Tom 3	808 Tom 3	House Tom 3	Jazz Tom 3	Brush Tom 3
48-C3	Electronic Tom 2	808 Tom 2	House Tom 2	Jazz Tom 2	Brush Tom 2
49-C#3	&lt;-	808 Crash 1	&lt;-	&lt;-	Brush crash 1
50-D3	Electronic Tom 1	808 Tom 1	House Tom 1	Jazz Tom 1	Brush Tom 1
51-D#3	&lt;-	&lt;-	&lt;-	Jazz Ride	Brush Ride
52-E3	&lt;-	&lt;-	&lt;-	&lt;-	&lt;-
53-F3	&lt;-	&lt;-	&lt;-	&lt;-	&lt;-
54-F#3	&lt;-	&lt;-	&lt;-	&lt;-	&lt;-
55-G3	&lt;-	&lt;-	&lt;-	&lt;-	&lt;-
56-G#3	&lt;-	&lt;-	&lt;-	&lt;-	&lt;-
57-A3	&lt;-	808 Crash 2	&lt;-	Chinese Cymbal 2	Brush Crash 2
58-A#3	&lt;-	&lt;-	&lt;-	&lt;-	&lt;-
59-B3	&lt;-	&lt;-	&lt;-	&lt;-	&lt;-
60-C4	&lt;-	&lt;-	&lt;-	&lt;-	&lt;-
61-C#4	&lt;-	&lt;-	&lt;-	&lt;-	&lt;-
62-D4	&lt;-	808 Mute Hi Conga	&lt;-	&lt;-	&lt;-
63-D#4	&lt;-	808 Open Hi Conga	&lt;-	&lt;-	&lt;-
64-E4	&lt;-	808 Low Conga	&lt;-	&lt;-	&lt;-
65-F4	&lt;-	&lt;-	&lt;-	&lt;-	&lt;-
66-F#4	&lt;-	&lt;-	&lt;-	&lt;-	&lt;-
67-G4	&lt;-	&lt;-	&lt;-	&lt;-	&lt;-
68-G#4	&lt;-	&lt;-	&lt;-	&lt;-	&lt;-
69-A4	&lt;-	&lt;-	&lt;-	&lt;-	&lt;-
70-A#4	&lt;-	808 Maracas	&lt;-	&lt;-	&lt;-
71-B4	&lt;-	&lt;-	&lt;-	&lt;-	&lt;-
72-C5	&lt;-	&lt;-	&lt;-	&lt;-	&lt;-
73-C#5	&lt;-	&lt;-	&lt;-	&lt;-	&lt;-
74-D5	&lt;-	&lt;-	&lt;-	&lt;-	&lt;-
75-D#5	&lt;-	808 Claves	&lt;-	&lt;-	&lt;-
76-E5	&lt;-	&lt;-	&lt;-	&lt;-	&lt;-
77-F5	&lt;-	&lt;-	&lt;-	&lt;-	&lt;-
78-F#5	&lt;-	&lt;-	&lt;-	&lt;-	&lt;-
79-G5	&lt;-	&lt;-	&lt;-	&lt;-	&lt;-
80-G#5	&lt;-	&lt;-	&lt;-	&lt;-	&lt;-
81-A5	&lt;-	&lt;-	&lt;-	&lt;-	&lt;-
82-A#5	&lt;-	&lt;-	&lt;-	&lt;-	&lt;-
83-B5	&lt;-	&lt;-	&lt;-	&lt;-	&lt;-
84-C6	&lt;-	&lt;-	&lt;-	&lt;-	&lt;-
85-C#6	&lt;-	&lt;-	&lt;-	&lt;-	&lt;-
86-D6	&lt;-	&lt;-	&lt;-	&lt;-	&lt;-
87-D#6	&lt;-	&lt;-	&lt;-	&lt;-	&lt;-

# MIDI Implementation Chart

	Function...	Transmitted	Recognized	Remarks
Basic Channel	Default Changed	10 ch X	1-16 X	
Mode	Default Messages Altered	X *****	*****	
Note Number:	True voice	0-127 *****	0 0	
Velocity	Note on Note off	O 99H, V=1-127 O (9 9H. V=0)	0-127 0-127	
After Touch	Key Channels	X X	X X	
Pitch Bend		X	O	
Control Change	0 1 5 6 7 10 11 64 65 66 67 8 81 91 93 120 121 123	X X X X X X X X X X X X X X X X X	O O O O O O O O O O O O O O O O O	Bank Select Modulation Portamento Time Data Entry Volume Pan Expression Sustain pedal Portamento ON/OFF Sostenuto pedal Soft pedal Reverb Program Chorus program Reverb level Chorus level All sound OFF Reset all controllers All notes OFF
Program Change		X	O	
System Exclusive		X	O	
System Common	: Song Position : Song Select : Tune	X X	X X	
System Real time	: Clock : Commands	O	X	START \ STOP
Aux Messages	: Local ON/OFF : All Notes OFF : Active Sense : Reset	X X O X	X X X X	

O : YES  
X : NO

## WEEE Declaration / Disposal



Your product is designed and manufactured with high-quality materials and components that are recyclable and can be reused. The symbol means that your product should be disposed of separately from household waste when it reaches the end of its service life. Please dispose of this equipment at your local collection point or recycling center. Please help to protect the environment in which we all live.

All specifications and appearances are subject to change without notice. All information was correct at the time of printing. Musikhaus Kirstein GmbH does not guarantee the accuracy or completeness of any description, photograph, or statement contained in this manual. Printed colors and specifications may vary slightly from the product. Products from Musikhaus Kirstein GmbH are only sold through authorized dealers. Distributors and dealers are not agents of Musikhaus Kirstein GmbH and have no authority to bind Musikhaus Kirstein GmbH legally in any way. This manual is protected by copyright. Any copying or reprinting, even in excerpts, is only permitted with the written consent of Musikhaus Kirstein GmbH. The same applies to the reproduction or copying of images, even in altered form.



### Musikhaus Kirstein GmbH

Bernbeurener Strasse 11

86956 Schongau

Phone: 0049-909494-0

Fax: 0049-909494-19

[www.kirstein.de](http://www.kirstein.de)

